

MEDIEVAL ART

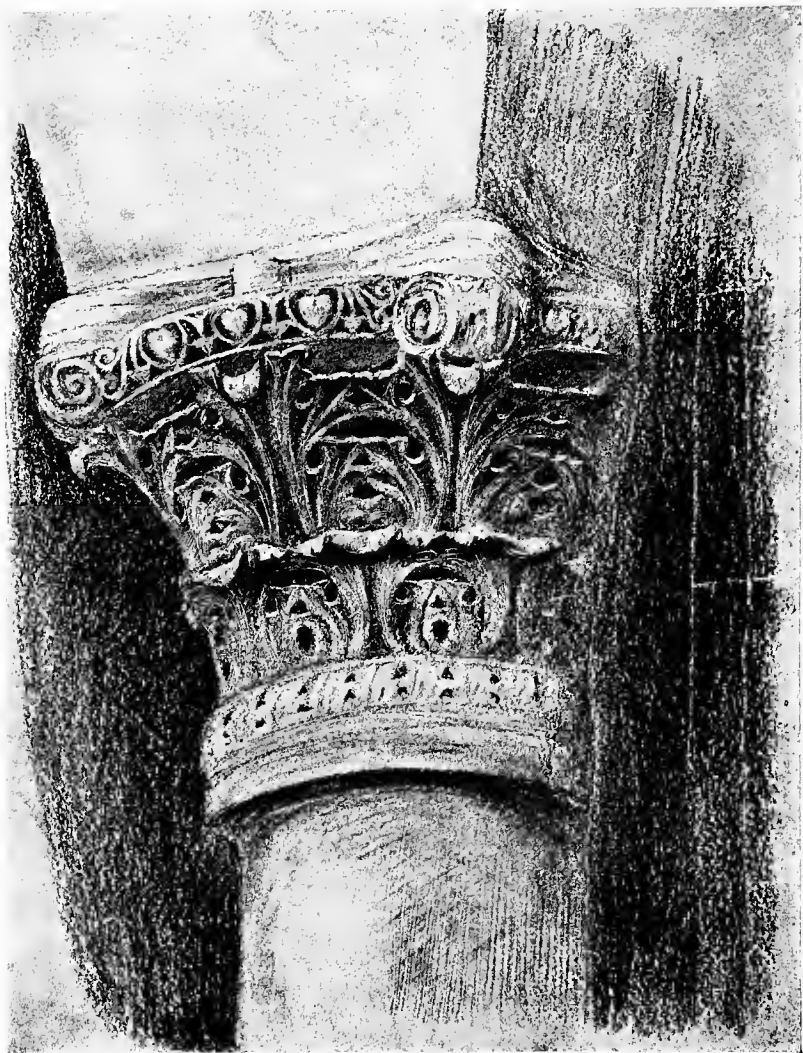

W. R. LETHABY

7728 E 27



W. R. L. from photo

BYZANTINE CAPITAL FROM THE MOSQUE OF DAMASCUS (See p. 63)

Frontispiece

MEDIÆVAL ART

FROM THE PEACE OF THE CHURCH
TO THE EVE OF THE RENAISSANCE

312-1350

BY

W. R. LETHABY



LONDON: DUCKWORTH AND CO.
NEW YORK: CHARLES SCRIBNER'S SONS

1904

D

+

+

“ Are we, then, also to be strong by following the natural fact ? Yes, assuredly.”

VAL D'ARNO.

PREFACE

As preface I should like to say a word on the great loss to knowledge that comes about from our having no accessible collection of photographs of historical works of art. Books can be collected at any time, but photographs are now very often the only authentic records of buildings which have been restored out of all validity. Every year travellers in out-of-the-way parts of the world, such as Sinai, Syria, Asia Minor and Armenia, bring back valuable photographic documents, but they are for the most part lost to science owing to there being no centre where they are collected. Again, during the whole of the last century English architects were diligently measuring or sketching all the mediæval buildings in Europe, yet very few original collections of material for this period are to be found, and it is to be feared that in the majority of cases such records have been destroyed. May I venture to point out to travellers that any of our national collections would, I am sure, treasure such drawings and also copies of photographs of interesting works of art ?

For the use of drawings and other kind services I wish to thank Mr. T. M. Rooke, Mr. S. C. Cockerell, Mr. A. Christie, Mr. A. H. Powell, Mr. R. W. Schultz, Mr. H. Ricardo, and Mr. H. F. B. Lynch. I must also particularly acknowledge the continuous help of E. C. L., especially in translating German, and in the preparation of the Index.

III INVERNESS TERRACE,
August 1904.

CONTENTS

CHAP.		PAGE
	INTRODUCTION	I
I.	THE AGE OF CONSTANTINE : ROME AND THE EAST .	9
II.	CONSTANTINOPLE, RAVENNA, AND THE AGE OF JUSTINIAN	32
III.	LATER BYZANTINE, AND ROMANESQUE ORIGINS .	63
IV.	ROMANESQUE ART IN ITALY	91
V.	ROMANESQUE ART IN GERMANY, FRANCE AND ENGLAND	120
VI.	OF ROMANCE ART	135
VII.	GOTHIC CHARACTERISTICS	154
VIII.	FRENCH CATHEDRALS	192
IX.	FRENCH SCULPTURE AND PAINTING	215
X.	FRENCH MASONS	243
XI.	GOTHIC ART IN ENGLAND, SPAIN, SWITZERLAND, BELGIUM, AND GERMANY	262
XII.	GOTHIC ART IN ITALY	276
	APPENDIX	299
	INDEX	305

ILLUSTRATIONS

LIST OF FULL-PAGE PLATES

PLATE		
I.	Byzantine Capital from Mosque of Damascus <i>Frontispiece</i>	
II.	Temple of Baalbec. Ceiling of Portico. <i>Facing page</i>	8
III.	Rome. Basilica of Sta. Sabina	" 22
IV.	Ravenna. Capital bearing monogram of Theodoric	" 32
V.	Constantinople. Sta. Sophia. Capitals, &c.	" 34
VI.	Ravenna. Impost-Capital. Sixth century	" 36
VII.	Ravenna. Impost-Capital from S. Vitale	" 38
VIII.	Ravenna. Impost-Capital from S. Vitale	" 40
IX.	Constantinople. Sta. Sophia. The great order of the interior	" 42
X.	Ravenna. Mosaics of Sant' Apollinare Nuovo	" 50
XI.	Ravenna. Mosaic portrait of Justinian .	" 52
XII.	Ravenna. Mosaic portrait of Theodora .	" 54
XIII.	Ravenna. Ivory Throne. Sixth century	" 56
XIV.	Damascus. Central part of Great Mosque	" 62
XV.	Ravello. Pulpit of parcel-mosaic . .	" 72
XVI.	Borgo San Donnino	" 90
XVII.	Florence. San Miniato. West front in 1875	" 98
XVIII.	Florence. The Baptistery	" 100

<small>PLATE</small>		
XIX.	Florence. Baptistery. Inlaid marble pavement	<i>Facing page</i> 102
XX.	Pisa. Detail of bronze doors	104
XXI.	Benevento. Detail of bronze doors.	106
XXII.	Milan. Interior of Sant' Ambrogio	110
XXIII.	Sicily. Cloister of Monreale	116
XXIV.	Bitonto Cathedral. Exterior gallery	118
XXV.	The Gloucester candlestick. <i>c.</i> 1110	124
XXVI.	Cologne. Church of the Apostles	128
XXVII.	Issoire. View of church from the east	130
XXVIII.	Morienvall. Abbey Church. <i>c.</i> 1125 before "Restoration"	134
XXIX.	Tracey-le-Val Church. <i>c.</i> 1130	140
XXX.	Beauvais. Apse and flying buttresses	154
XXXI.	Bourges. Glass. Christ of the Apocalypse	176
XXXII.	Chartres. Glass. Figure of donor, Guy de Montfort	180
XXXIII.	Strasbourg. The pulpitum, now destroyed	184
XXXIV.	Strasbourg. Part of west front	188
XXXV.	Paris. Notre Dame, west front	192
XXXVI.	Sens. West door	198
XXXVII.	Reims. Door of north transept, <i>c.</i> 1230-1240	206
XXXVIII.	Bourges. West porches	208
XXXIX.	Rouen. Choir	210
XL.	Rouen. Lateral door of west front.	212
XLI.	Chartres. Sculptures of western doors	214
XLII.	Chartres. Jambs of left-hand and central doors of north porch	222

ILLUSTRATIONS

xiii

PLATE		
XLIII.	Chartres. Jambs of left-hand and central doors of south porch	<i>Facing page</i> 224
XLIV.	Amiens. Solomon and Saba. South door of west front	” 226
XLV.	Amiens. Herod and two of the Magi. South door of west front	” 228
XLVI.	Reims. Jamb of central porch	” 230
XLVII.	Reims. Joseph	” 232
XLVIII.	Reims. Simeon	” 232
XLIX.	Reims. Central porch. Angel	” 234
	L. Auxerre. Sculptures of the west porch	” 236
	LI. Auxerre. Sculptures of the west porch	” 236
	LII. Strasbourg. Central pillar in the south transept	” 238
LIII.	Amiens. Reliefs of the Virtues and Vices	” 242
LIV.	Amiens. The Signs of the Zodiac and the labours of the year	” 244
LV.	Amiens. The Signs of the Zodiac and the labours of the year	” 246
LVI.	Paris. The Virgin. From north tran- sept door of Notre Dame	” 252
LVII.	Abbey of Villars. Monastic transitional style	” 262
LVIII.	Lausanne. South transept before “Restoration”	” 272
LIX.	Bruges. Hôtel de Ville and belfry	” 274
LX.	Bologna. Monument of Rolandino. c. 1300	” 276
LXI.	Bitetto Cathedral. South Italian work	” 278
LXII.	Palermo. Window of S. Agostino	” 280
LXIII.	Florence. Sculptures from the cam- panile	” 284

PLATE	
LXIV. Florence. Sculptures from the campanile	<i>Facing page</i> 286
LXV. Orvieto. Door jamb "Cosmati work"	288
LXVI. Beauvais. House front. c. 1550	296

LIST OF DIAGRAMS, PLANS, AND DRAWINGS IN THE TEXT.

FIG.		PAGE
1.	Pottery vessel, <i>circa</i> 320, in British Museum	3
2.	Early Christian tomb	10
3.	"Temple of Minerva Medica." From a drawing in the Soane Museum	11
4.	Late Roman building. From a drawing in the Soane Museum	12
5.	Plan of Early Christian basilica, Saglassos, in Asia Minor. After Strzygowski	14
6.	Plan of Early church at Dodona	14
7.	Pine-cone fountain, from a Byzantine MS.	20
8.	Spandrils of arches in Sta. Sabina, Rome. From a drawing by Mr. A. Christie	21
9.	Plan of Sta. Constantia, Rome. From a drawing in the Soane Museum	23
10.	Early Christian church, Silchester	25
11.	Early Christian church, Jataghan, Asia Minor	25
12.	Suggested plan of churches of the Holy Sepulchre	26
13.	Churches of the Holy Sepulchre, from the Madaba mosaic	27
14.	Tomb chamber in the Rotunda of the Holy Sepulchre	29
15.	Roman temples altered into Church of SS. Cosmo and Damian	30
16.	Stone friezes of fourth or fifth century, after Strzygowski	33

ILLUSTRATIONS

XV

FIG.		PAGE
17.	Stone capital from Old Cairo	34
18.	Ivory panel in Cairo Museum	34
19.	Diagram of Syrian arch-form	35
20.	Mosaic pavement from Carthage, in the British Museum	36
21.	Byzantine capital of sixth century, in mosque of Kerouan	39
22.	Byzantine capital found in Rome. After Piranesi .	40
23.	Capital from church in Isauria, Asia Minor . .	41
24.	Diagram of dome of St. Sergius, Constantinople .	43
25.	Plaster rib on the same dome	43
26.	Plan of Sta. Sophia, Constantinople	45
27.	Approximate plan of Church of the Holy Apostles, Constantinople	47
28.	Plan of St. Vitale, Ravenna	51
29.	Monograms	55
30.	Basilica at Bethlehem	57
31.	Byzantine candlestick	59
32.	Diagram of lower story of palace at Mashita in Moab	61
33.	Plan of monastic church of Daphne, near Athens .	69
34.	Plan of church on the island of Chios	69
35.	Church of the Apostles, Salonica	70
36.	Plan of Church of St. Elias, Salonica	73
37.	Plan of Church of St. Gregory, Etschmiadsin, Armenia	74
38.	Plan of Cathedral of Etschmiadsin, Armenia . .	75
39.	Church of Ushkal Souanetie in the Caucasus . .	76
40.	Church at Anabat, Van, in Armenia	77
41.	Diagram of Church of Vatopedi, Mount Athos .	80
42.	Plan of basilica at Barkal, near Dongola . . .	82
43.	Plan of basilica at Kef	83
44.	Plan of church at Doclea, Montenegro	83
45.	Plan of church at Nyssa	85

FIG.		PAGE
46.	Cruciform font	87
47.	(A) Plan of S. Croce Camerina ; (B) Plan of S. Maria di Squillace ; (C) Its crypt	88
48.	Plan of destroyed Church of St. Andrea, Rimini	89
49.	Part plan of St. Mark's, Venice	94
50.	Haikal of church at Antinoë in Egypt	95
51.	Sections of moulding, St. Mark's, Venice	96
52.	Patterns from wall linings in (A) San Miniato, Florence ; (B) St. Demetrius, Salonica	98
53.	Grouped shafts, St. Michele, Lucca	106
54.	Panel from St. Paolo, Pisa	106
55.	King David, from the Baptistry, Pisa	107
56.	Inlaid marble pillars. St. Michele, Lucca	108
57.	Figure in mosaic. St. Ambrogio, Milan	110
58.	Ribbed vaults from Church of Skripou	112
59.	Pillar from crypt of Modena Cathedral	113
60.	Tomb of two masons	118
61.	Plan of Church of Aachen	122
62.	Plan of destroyed Church of Valenciennes	149
63.	Plan of Church of Cistercian abbey of Chaalis	150
64.	Destroyed abbey church of St. Mary, Soissons	152
65.	Diagrams of vaults	155
66.	Diagrams of vaults	157
67.	Section of nave, Amiens	160
68.	Plans of church at Chars, Oise	162
69.	Plan of E. transept and chevet, St. Quentin	163
70.	Plan of Church of St. Yved at Braisne, near Soissons	165
71.	Plan of Church at Villeneuve-le-Vicomte	166
72.	Plan of destroyed Church of Vaucelles	167
73.	Plan of the Templars' chapel, Laon	168
74.	Plan of Angers Cathedral	169
75.	Section of hall of St. Martin des Champs	170
76.	Apse windows of Auxerre	171

ILLUSTRATIONS

xvii

FIG.	PAGE
77. Rose and lancets, Ourseamp	172
78. Early traceried windows, Reims	172
79. Early traceried windows, Amiens	173
80. Rose window of N. transept, Châlons	174
81. Rose window, Notre Dame, Paris	175
82. Triforium windows, Amiens	176
83. Stained glass from S. transept, Chartres	177
84a. Upper part of window called Notre Dame de la Belle Verrière, Chartres	178
84b. Lower part of same window	179
85. Portion of window from Laon	181
86. French Gothic mouldings	186
87. Gothic mouldings from Normandy, and base from Noyon	187
88. Ground plan of Laon Cathedral	196
89. Sketch of one of the W. towers, Laon	197
90. Plan of Notre Dame, Paris	200
91. Notre Dame, Sainte Chapelle and clock-tower of palace. From Froissart MS	202
92. West front, Chartres	205
93. Tomb of Louis, eldest son of St. Louis, at St. Denis	217
94 and 95. Effigies called Childebert I and Clovis II. St. Denis	220
96 and 97. Effigies called Louis III. and Carloman. St. Denis	224
98 and 99. Effigies of Philippe III. and Jean II. St. Denis	227
100 and 101. Effigies of Robert and Marguerite d'Artois. St. Denis	232
102. Painting a statue. From a MS.	235
103. Daughters of Sion. From stained glass at Orbais	236
104. Moses. From stained glass at Orbais	237
105. Study by V. de Honnecourt	238

FIG.	PAGE
106. Portrait from grave-slab, Châlons-sur-Marne . . .	239
107. Portraits from grave-slab, Châlons-sur-Marne . . .	240
108. Hugh Libergiers, master mason of Reims . . .	246
109. Drawing by V. de Honnecourt of apse of Cambrai . . .	249
110. Eudes de Montreuil, master mason of Paris . . .	252
111. Master mason of apse of St. Ouen . . .	254
112. Gravestone of a master mason, Cluny Museum . . .	256
113. From gravestone of a master mason at Caudebec . . .	257
114. Seal of master mason of Strasbourg . . .	258
115. From stained glass at Chartres . . .	259
116. (A) Original design for W. front of thirteenth century church. (B) Suggested interpretation . . .	260
117. Inscription in honour of the master mason of Notre Dame	261
118. Suggested original form of E. end of Lincoln Cathedral	268
119. Ground plan of Lausanne Cathedral	272
120. Early altar front. Coire	273
121. Detail of altar front. Coire.	274
122. Shrine and altar formerly in S. Maria Maggiore, Rome	283
123. City gate and Baptistery, Florence. From a MS.	288
124. From stone slab in the Cluny Museum	296

INTRODUCTION

"The knife is in the meat, and the drink is in the horn, and there's revelry in the hall, and except for a craftsman who brings his craft the gate will not be open to-night."—*Mabinogion*.

ART is man's thought expressed in his handwork. The course of art has left a great series of documents for the history of civilisation. Moreover, the quality, importance, and number of monuments are likely to vary according to the greatness of the periods in which they were produced. They are witnesses which cannot lie; they are, indeed, not so much records of the past as samples of actual history. Westminster Abbey is a great piece of the middle of the thirteenth century still projecting above the later strata of English life and effort. Periods of art are those in which a process of development has been set up by which certain ideals have been followed for generations and centuries, so that possibilities of thought-expression have been continuously explored and built up. In such great art are crystallised the aspiration and consciousness of an era of national life.

A wide view of history makes it evident that periods of art have coincided with the crests of general development. Where we have no other chronicle it is safe to argue from

the existence of a school of art to a period of culture of which it was the outcome. For instance, we know nothing of the people who built Stonehenge but Stonehenge itself; we know little of the Mycenæans save the wonderful remnants of their work-civilisation; and in the long chain of Egyptian culture undulations in the state of society may be directly inferred from the index curve of art, and we know that the Great Period synchronised with the reigns of Seti and Rameses. It was Pericles who raised the Parthenon, and Augustus who gave his name to the great Roman epoch. Old St. Peter's stood for the first power of the Christian Empire, and Sta. Sophia for its Eastern culmination under Justinian. The Dom of Aachen marks the rule of Charlemagne; Jumièges and Durham witness to the might of the Normans; the building of Notre Dame coincides with the rising power of Philip Augustus; and our own English art came to its crown with Edward I.

It would be of interest to trace the movements of the art centre of Western civilisation from generation to generation and to mark out the forces radiating from the several points by a sort of artistic meteorology.

Every school of art is the product of antecedent schools plus the national equation of the moment, and these two factors may either be found as almost distinct and existing side by side, or they may run together into a new compound form. So true is this that the history of art may be compared to chemical analysis; and one of the offices of its historian is to distinguish and weigh the component parts of any given example. If his tests were rigorous enough he should be able to trace every element.

At the time when our story begins Roman art had long been subjected to Greek influence, and the centre of development was in the east of the Empire rather than in Rome. Moreover, the needs and desires of the Church, itself of the East, soon further sweetened and freed official



FIG. 1. Pottery vessel in the British Museum. A figure of Christ with cruciform nimbus between profiles of Constantine and Faustina, who are named in the surrounding inscription : c. 320, probably of Syrian or Egyptian origin.

Roman art into Early Christian art, which quickly spread over an enormous field—over Syria, Asia Minor, Arabia, Armenia, North Africa, and Egypt, where early churches are found far up the Nile beyond Khartum.

After the fourth century Constantinople became the artistic capital of the world, but only maintained its pre-eminence until the rise of the Mohammedan Empire, when

the vital centre moved eastward. The early buildings of the Arab conquerors, erected for them by Christian builders in a style at first Byzantine, or more properly what we might call Hellenesque,* and then slowly changing into more Eastern complexions, form one high peak in the chain of art. The Dome of the Rock, the Aksa in Jerusalem, and the Mosque of Damascus, are more energetic and clearer in expression than any other architecture of the time. The Arab-Byzantine school attained enormous power, and, indeed, this Eastern wave of Hellenesque art is not yet exhausted in Persia and India.

To come back to Rome and the West. During the years of the Gothic wars and the folk-migrations art must have been almost wholly eradicated, and such as remained was compounded of the dying classical tradition, of barbarism, and of the fresh influences of the Christian East.

When Theodoric set up a stable society, with its centre at Ravenna, he borrowed from the art of Constantinople, and not long afterwards Ravenna became the seat of an exarch representing the Eastern Empire. From this time the Eastern element was for centuries the most vital one in Italy and the West.

When Charlemagne, having founded the new Empire, built his monumental church at Aachen at the end of the eighth century, he obtained marbles and mosaics from Ravenna, and it was planned like San Vitale in that city and other churches further east. The influences emanating

* By "Hellenesque" I mean most simply the Oriental Christian styles, including Byzantine. It was developed out of the Hellenistic art as Romanesque is generally supposed to have developed from Roman.

from the Carolingian centre in turn affected the whole West. After the division of the Frankish Empire followed a period of disintegration and stagnation, until, with Otto II., a time of renewed energy began, and from this we may date the origin of the great Rhenish school.

In the tenth and eleventh centuries several forms of what is usually called Romanesque art arose in various States in North Italy and France. Of these States, one of the most powerful was Normandy, and here was early developed a great branch of Romanesque art which was soon carried into England.

During all this time further waves of Oriental impulse passed westward, especially over the southern parts of Italy and France; and with the Norman conquest of Sicily a mixed style arose there out of northern and eastern elements.

In the middle of the twelfth century the germ of modern France, the small royal domain, began to wax in power, and at this moment its local phase of Romanesque began to change and speedily matured into Gothic, a noble and adventurous style which formed the western efflorescence of art in the Christian era.

In briefest summary, there are two chief styles of mediæval art to be dealt with in these pages—the eastward culmination, or the Byzantine school, and the western, or Gothic. To recapitulate from this point of view. The long and eventful period, the thousand years from A.D. 300 to 1300, from Roman to Renaissance art, is yet a perfectly organic one. It begins with a change in the spirit of Classical art, produced by Oriental mysticism and Christianity, which profoundly affected the subject-

matter dealt with, and supplied an epic interest and human meaning which had been so markedly lacking in it. This soon brought forth the first great mediæval school in the East. After the mighty disturbances in the West, when Goths, Franks, Lombards, and the rest flowed in over the Roman Empire, when western society began once more to solidify, to wake to national consciousness, and to desire the works of peace, it was natural that men should turn towards the great artistic capitals of the East, and absorb what they might of the traditions which had in them been preserved. The populations of Western Europe had in different measures been freed and re-barbarised, and the arts they now developed witness perfectly both as to the derived seed and the new ground in which it was planted.

In France, as I have said, the diverse elements again ran together in the twelfth century and formed the western mediæval school known as Gothic, an art perfectly clear, energetic, and homogeneous, in which the sculpture and painting were as noble as the structures were direct and daring. This French-Gothic school was widely spread over Western Europe by the middle of the thirteenth century, and was even carried into Italy, where it influenced the native Byzanto-Romanesque, and formed many exquisite mixed styles by the time that the millennium of mediæval art drew towards its end.

In Italy, however, Gothic art was never fully assimilated, and it seems probable that it was even a conscious reaction of artistic patriotism against this Northern art that led to the endeavour to bring back the past of Rome, and initiated that substitution of scholarship for experiment the

which is the central principle of the Renaissance architecture by which Roman authority once again conquered the world.

Of the causes which produced the phenomena of Mediæval Art, a large share is, as will be shown, to be assigned to Eastern forces acting on the West. A thousand years of receptivity seems to have come to a close with the Renaissance.

The Gothic, indeed, stands out as exclusively a western style, but even this came as a short summer time, fulfilling a long growth from widespreading roots, nourished by the rivers of Eden. There is much more of the East in Gothic, in its structure and fibre, than is outwardly visible. To account for Gothic we have to account for its historic basis and for the whole atmosphere of mysticism, chivalry, and work-enthusiasm, with all the institutions, monastic, romantic, and social, which formed its environment. Looking at the slow preparation for, and the rapid passing of, western gothic art, and considering the sudden and entire breakdown of its traditions and ideals, I am drawn to the conclusion that the causes which underlay this art are to be found in a long infiltration of the Oriental spirit to the point of saturation, and then the bursting out of the new, yet old, energy shaped to northern requirements.

I must not here bring forward particular instances to illustrate and fortify this hypothesis, but I may suggest that it will appear more probable when we survey mediæval art as a whole, both historically and in its geographical distribution.*

* On eastern influence in western art see *Byz. Zeits.* 1903 and *American Jour. of Archæology*, 1894 and 1895.

It is not generally realised in how large a degree the Persian, Egypto-Saracenic, and Moorish forms are members of one common art with Gothic and developed side by side with it. Gothic art, however, as it progressed broke away more and more from the body of ancient customs. The history of art between the Byzantine era and the present day, as can be seen with least confusion in the comparatively free arts of painting and sculpture, is the history of a transition from common tradition to individualist realism. Architecture has followed the same course, although the issue in regard to it has been more obscured and blocked by many attempted revivals of old forms.

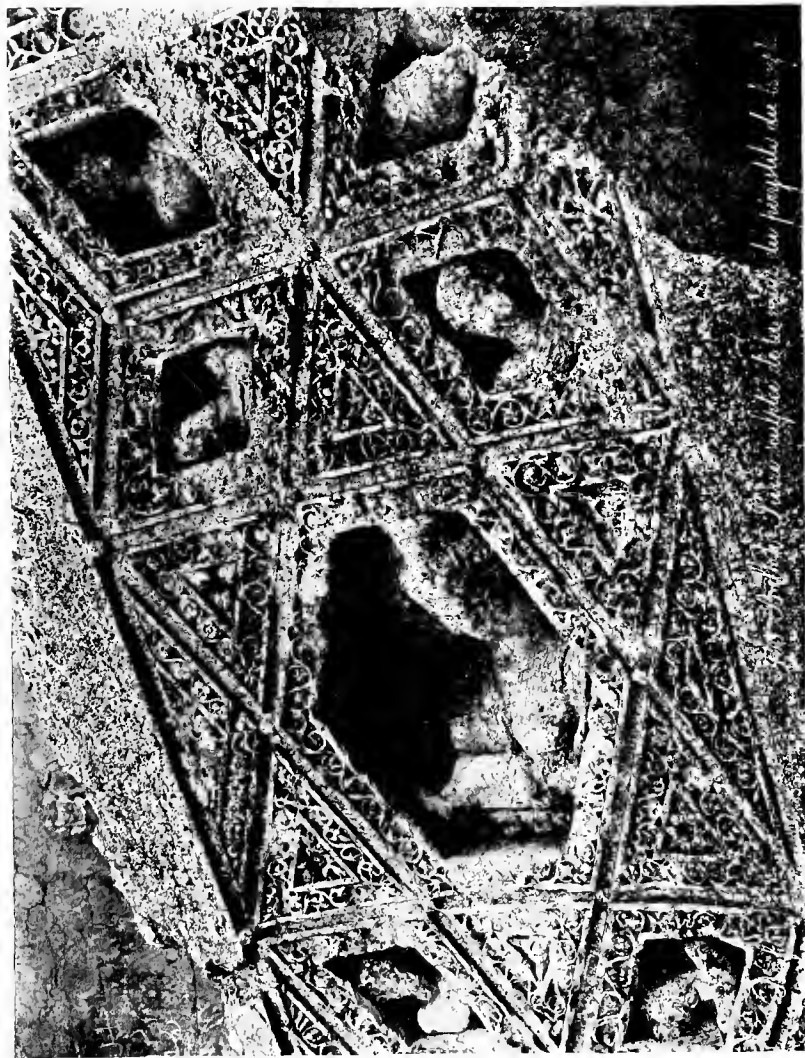

Bonfils

TEMPLE OF BAALBEC. CEILING OF PORTICO (See p. 15)

Face p. 8

CHAPTER I

THE AGE OF CONSTANTINE: ROME AND THE EAST

THE mighty Empire of Rome at the time when our inquiry begins was already showing signs of breaking up into three main divisions—the East, where the empire was continued for more than a thousand years; Italy, where the Pope once more built up a great centralised power; and the Western Provinces, over which flowed the Germanic invasions. Recent writers give a preponderating influence in the transformation of classic art into Christian, to such late Greek centres of culture as Alexandria, Antioch, and Ephesus, rather than to Rome. Dr. Strzygowski has presented the evidence for this view in a series of learned works.

Rome itself, long before the Edict of Milan in favour of Christianity in 313, had been subject to Eastern influences; indeed, the removal of Constantine's capital to Byzantium a few years later, in 330, can only have been the result of great causes, long in action, which showed that the true centre of the empire's life was nearer to the East. There is a great difference between earlier and later Roman art, which is probably to be accounted for by increasing Oriental influence. This is particularly marked

in the Palace built directly after 300 at Spalato by Diocletian, which is distinctly Syrian. Even the colonnaded streets of Damascus and Gerash are repeated in this vast palace enclosure, and the architectural details resemble work at Baalbec and Palmyra.

The great monument which best marks the change of



FIG. 2. Early Christian tomb front.

style, the Pantheon, was built more than 150 years before this time by Hadrian,* and the interval is filled by some extremely interesting buildings, of which the so-called Temple of Minerva Medica is a good example. This building is properly a Nymphæum, erected about 260. There is a valuable unpublished plan of it made about 1512 by Conero in his folio of original drawings now in the Soane Museum. The central chamber followed the most perfect type that can be devised; the area being enlarged, and, at the same time, the construction strengthened,

* The vast Imperial Villa at Tivoli, recently well described in Gusman's fine volume, and which also dates from this time, shows how free and masterly was late Roman construction.

by a series of domed recesses. These rise only to the half height, above which the thinner wall of the central chamber is supported by buttresses. The disposition of the lateral buildings given on the plan (see Fig. 3), which have now entirely disappeared, shows that the prin-

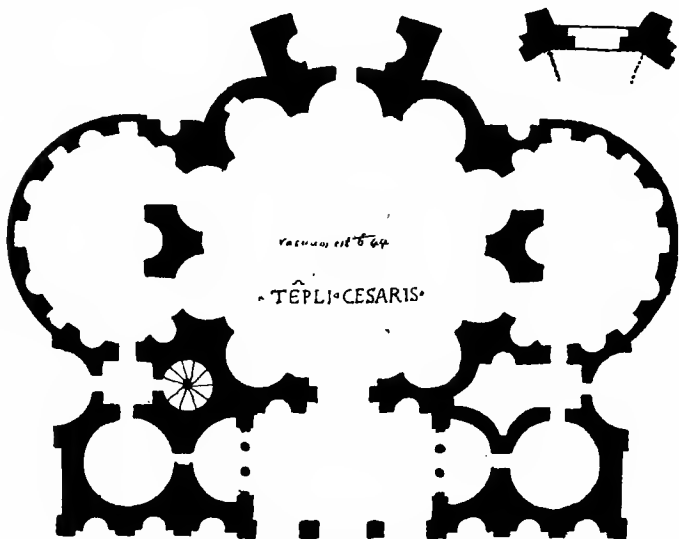

FIG. 3. " Temple of Minerva Medica," Rome, from an original drawing in the Soane Museum, made *c.* 1510.

ciple of supporting a high central dome by lower vaults was fully understood. The walls of the interior were once covered with slabs of porphyry and marble, and its dome was encrusted with shells and glass enamels.* From

* I find an interesting early *view* of this building about 1500 in the Italian engraving of Leda by the Master I. B. in the British Museum.

the same source is taken Fig. 4, a remarkable octagonal plan, which must be late Roman, although I cannot identify it.

In this later Roman school, building was carried to as high a point as it has ever reached. Construction was experimental, yet masterful, and all manner of exquisite

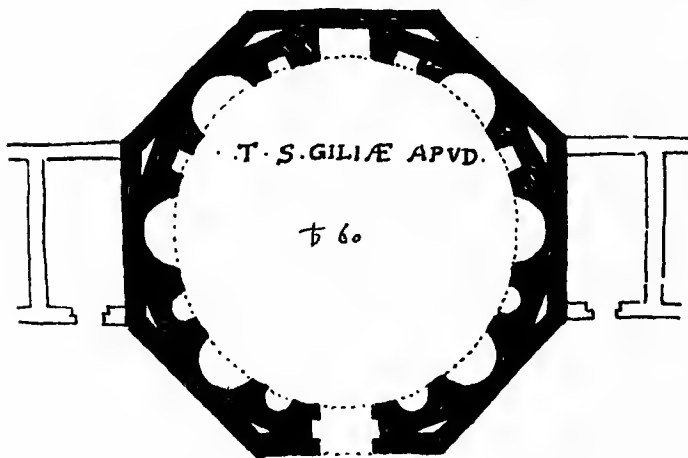

FIG. 4. Late Roman building, from a drawing in the Soane Museum, made *c.* 1510.

materials like coloured marbles, glass mosaic, and gilded bronze, were used in never equalled profusion, with fine freedom of handling, and often with excellent, if somewhat redundant, taste. Yet one thing it lacked to make it that still nobler thing—a great school of architecture. The elements of sculpture and painting were merely formal, and in no way epic; they were added to a building as adornments, and were not the very soul of its life. The

times in history when building, sculpture, painting, and other arts have been perfectly co-ordinated into a higher unity have, indeed, been very few; but if we are to distinguish between fine building and noble architecture this organic unity must be the test.

In the Constantinian epoch there were two schools of "decorative" art in Rome—one, splendid, academical, and, on its expressive side, formular; the other, the humble art of an Eastern sect hidden in the catacombs—a living art for the dead. Not only did the two schools respond to two classes of demand, but the artists must have belonged to entirely different camps. On the one side they were accurate, cultured, official; on the other, simple, and almost amateur, yet their work was penetrated with ideas and full of emotion. The bringing of these elements together formed Constantinian art in Rome.*

It is a pity that Roman buildings have been examined under the guidance of the text of Vitruvius by men who looked for "Orders of Architecture" rather than for living experiment in building. And a great advance towards a reasonable view of Roman art has been made by Choisy's studies of the principles of Roman construction. We further need above all a scientific study of Roman planning, abundant materials for which have now been collected.

Many of the links in the development and transformation of ancient art must have been irrecoverably lost by the destruction of Eastern cities.

* On the Catacombs, see Wilpert's fine book.

For instance, Maundrell, in 1699, saw a remarkable building at Corus, near the borders of Mesopotamia, which he describes as "a noble old monument, six-square, which opens at six windows above, and is covered with a pyramidal cupola. In each angle within is a pillar of the Corinthian order of one stone, and there is a fine architrave all round just under the cupola, having



FIG. 5. Early Christian Basilica, Saglassos, in Asia Minor. After Strzygowski.



FIG. 6. Early Church at Dodona, with transverse triple apse.

had heads of oxen carved on it, and it ends at top with a large capital of the Corinthian order."

Especially significant in regard to painting are the wax painted portraits from Egypt, some of which are shown in the vestibule of the National Gallery. They furnish the very facial types which are afterwards found in the catacombs and in the mosaics.

In Syria the transition from classic art to Christian can be traced through a large series of dated monuments, as is shown by the recently published results of the American

Archæological Expedition. And it appears that from first to last this Eastern art was Hellenistic rather than Roman. I do not suppose that there were any structural or decorative methods which were not absorbed by the artists of the Empire; Roman art, like its culture generally, was syncretic. Some of the decorative processes largely used in Christian art, such, for instance, as incrustation of wall surfaces with a veneer of precious marbles, seem especially to have been delighted in at the capital. But the informing spirit of architecture, and the way of looking at ornament, was very different in Rome from what it was in the East. The characteristics of Eastern art throughout are greater freedom in structure, and closer reference to nature with constant variety in ornamentation. We already have pure naturalism aimed at in the Assyrian reliefs. The fine Hellenistic sarcophagus from Sidon called "Alexander's" has a most exquisite meander of vine carved on its frieze. In the series of monuments represented by the Golden Gate at Damascus, and the ruins of Palmyra and Baalbec, besides the unfettered way in which the so-called "order" is treated, the carved ornamentation shows a strong life, full of imagination, executed in a forceful way. At Baalbec the frieze is practically suppressed; it has become a band of carving lying flush with the outer member of the architrave, and under-carved so that the light falls through it as through a trellis. The "palmette" ornament of the cyma is continually changing in pattern, and even the "egg and tongue" moulding is made interesting from point to point by changing patterns in the alternating spaces. (Compare Plate 2.)

In these, and still more markedly in several Hellenistic sarcophagi, is to be seen a new principle in regard to sculptured ornament, a principle that becomes typical in Byzantine carvings, whereby the sunk portion is not regarded as a mere background, but as an alternating form. By this method sharply-defined shadows seem to be inlaid into the general shape of the member decorated. In the West the Palace of Diocletian at Spalato is certainly an offshoot of this school of art.

Even the Basilican church must have been developed outside of Rome. As early as 325, as an inscription shows, was built the little church of Orléansville in Algeria. Strzygowski thinks that some of the many churches found in Asia Minor may date from pre-Constantinian days. (Fig. 5 is of uncertain date.) The church at Nicomedia, destroyed in the Diocletian persecution, must have been built before the end of the third century. A description of what was probably a church of the second century is given in a Syriac MS., the *Testamentum Domini*.* And still earlier the vision of the Heavenly Temple in the Book of Revelation must be based on the form of churches built by men.

The type of the primitive church was formed by the composition of many elements. The apsidal presbytery with its altar is so clearly in direct correspondence with the rite there celebrated that it is unnecessary to look for any other origin. It resembles the *triclinia* of private houses; an alternative derivation has been suggested from the little memorial *scholæ* built above the entrances to the catacombs in Rome, some of which have tri-apsidal

* *Rev. Art Crét.* 1899, p. 515.

terminations, like the church shown in Fig. 6.* But it is to be observed that memorial feasts were held in these buildings, and it is most probable that they were independently derived from the great apsidal dining-halls. This, therefore, furnishes some confirmation of the first theory, and in any case these little buildings are probably too local and too late to have influenced the first churches.

Certain traditions of temple-planning were also carried forward—notably in the orientation of churches, which, like temples, are built on an east to west axis, and the earlier churches had their great doors to the east like the temples, and in exact opposition to the later custom of having the doors to the west. The Atrium may also come from the forecourt of temples. It was natural when great churches were built for a large assemblage of people that, having to fulfil purposes analogous to those of the basilicas of justice, they should take over from them the colonnade and roof system as a current tradition of building. It is not that the church entered into the justice halls, but similar needs of covering large spaces brought about similar results. The word Basilica was in use for a church in Constantinian days, but it seems to have been applied to any form of church.

We will now turn to the first Christian churches of Rome.

Constantine, it is said, at the suggestion of Bishop (Pope) Sylvester, built the basilica of St. Peter, over the tomb of the Apostle, whose body he placed in a

* Churches of this form are not known in Rome. The finest are the White and Red Monasteries in Egypt, both of the fifth century.

chest of bronze.* Directly above it stood the porphyry columns of the altar ciborium, and he placed between the apse and the body of the church some beautiful columns carved with tendrils of vine, which he brought from Greece. The church was a vast structure, having five avenues between colonnades, crossed at the end by the transept, from the centre of which, behind the beautiful vine columns, opened the apsidal presbytery, raised high above a crypt, and approached by a flight of steps on either hand. Around the apse were the presbytery seats in raised banks, the Pontiff's throne being against the curved wall on the axis. Under the altar was the *confessio* of St. Peter,—the crypt which contained the tomb of the Apostle,—which was approached by a central flight of steps in front of the altar. Above the vine columns was an entablature which was enriched with plates of silver and supported candelabra. The nave was divided from the transept by the “triumphal arch,” which was a little later covered with mosaic showing St. Peter presenting Constantine to Christ, to whom he was offering a model of the church. Across the arch was another beam, the head of the arch being filled with lattice-work, against which were attached a cross and two gigantic keys. This beam corresponds to the Rood beam in later Western churches. Nearly under it stood the ambo, in front of which, in the nave, a space was enclosed by low screens for the choir of the singers. The walls of the nave above the architraves supported by

* As the lateral walls of the Basilica stand on old Roman foundations, that the Apostle's body should have been found thus conveniently laced is nearly a topographical impossibility.

the colonnades were entirely painted over with histories from the Bible. On the north side, between the windows, were Prophets, and beneath, panel pictures beginning with the animals entering the Ark. Opposite, to the south, the pictures were from the New Testament. The roof, of low pitch, showed its tie-beams and other timbers. In the *eastern front* of the church opened five entrances; the great central doors being adorned with silver, on which were figures of St. Peter and St. Paul. A forecourt, or atrium, was surrounded by colonnades, in the midst of which was a fountain in the form of an enormous gilt bronze pine-cone throwing threads of water from multitudinous holes, and canopied over by bronze lattice-work, on which perched beautiful bronze peacocks. The outer gates of the atrium were adorned with mosaic. The façade of the church, rising above the cloister colonnade, was also covered with mosaic, where three ranges of figures portrayed Christ between the Virgin and St. Peter, with the four symbolic beasts, then the Evangelists themselves, with their books, and below the twenty-four elders putting off their crowns. This façade, with its mosaic, is shown in an eleventh-century manuscript preserved at Eton. The great church was but one building of a group. On the south side rose two circular Imperial tomb chapels, and on the north side was the palace of the Popes—a castle surrounded with walls and strong towers.

The solemn beauty of St. Peter's with its gable-mosaic shining in the morning sun as the people passed through the fountain court, and assembled for the early service in its dim, long-avenued interior, may hardly be imagined.

Of all these things only the pine-cone, two of the peacocks of the fountain, and several of the vine-columns which stood before the presbytery, remain to us. These last, according to one story, were said to have come from Solomon's Temple, and they are figured in Raphael's celebrated cartoon of the Beautiful Gate of the Temple. The pine-cone is antique, and bears the signature of *P. Cincius Salvius*, it has recently been shown that it was probably only placed in the "Paradise" of St. Peter's about 1100, but Strzygowski says that a pine-cone was the traditional form for Church fountains. Compare Fig. 7 from a Byzantine MS. The decorations of St. Peter's were mostly later than the structure, and were added from time to time through the ages.

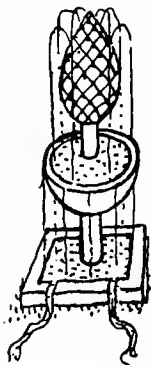

FIG. 7. Pine-cone fountain from a Byzantine MS.

Constantine's basilica of St. Paul's outside the walls was quite a small church, the plan of which has been recovered by excavation. It was rebuilt from 386 as a large five-aisled basilica, facing in the other direction.

At St. John Lateran only the Baptistery seems to have been built by Constantine, and of this a portion remains.

We cannot stay to refer to any more of the basilican churches in Rome, save only to say that Sta. Sabina, built about 430, is probably the most complete and unharmed, and contains many early treasures in its mosaics, carved doors and marble incrustations. For

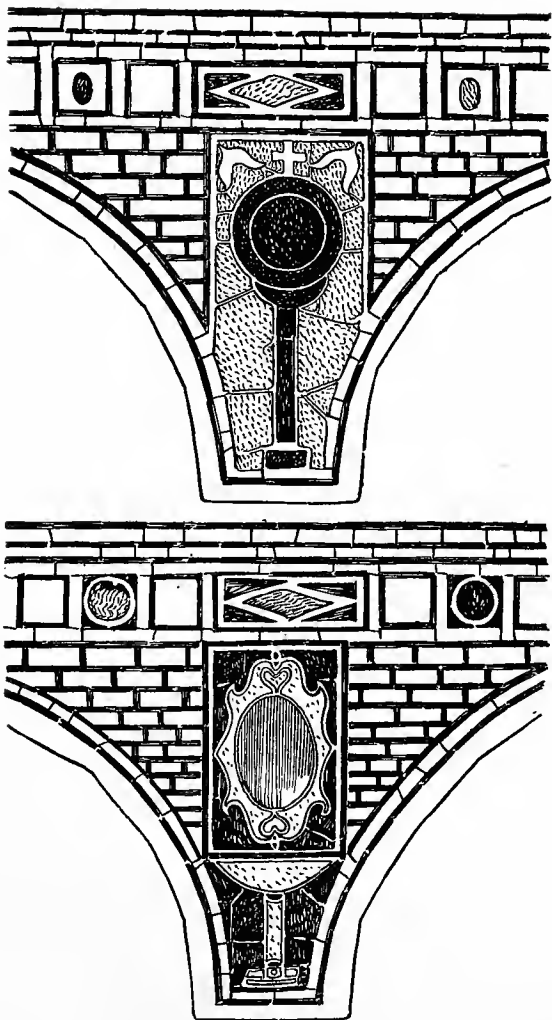

FIG. 8. Marble plating from spandrels of arches in Sta. Sabina, Rome, from a drawing by Mr. A. Christie.

these last see Fig. 8; this method of plating surfaces with precious materials fitted in patterns was much used in both late Roman and Byzantine work, and it seems to have been a Roman gift to Christian art (Pl. 3).

A few steps from the early basilica of Sta. Agnese outside the walls is the best preserved of all of Constantine's churches, the circular building which it is said contained the tomb of Sta. Constantia. A central dome rises over a ring of arcades, the columns of which are coupled perpendicularly to the circumference. I give an early plan (Fig. 9) of this interesting building made by Conero about 1512. It gives no sign of the exterior circular colonnade shown by Dehio, Kraus, and others. To the exterior it has a cornice of plastered brick with marble modillions, and the walls were probably plastered.

The mosaics of the central dome have been destroyed, but there was once a Baptism figured here. "This fact and the discovery of circular walls beneath the middle of the rotunda have suggested that this mausoleum might have served for a Baptistery."* Now our own Bede says that Constantine built a basilica to the Holy Martyr Agnes at the request of his daughter, "and a Baptistery in the same place where his sister Constantia and her daughter were baptized."

The vaults of the circular aisle are covered with most interesting fourth-century marble mosaics representing intertwined vines with "Putti" busy with the labours of the vintage. Around the lower part of the dome the mosaics represented a river in which cupids fished and

* Marucchi, 1902.



174

174

played with water-fowl in a late classical taste, but on it, opposite the door, floated the Ship of the Church. Above this river rose a sort of pergola of conventional foliage set

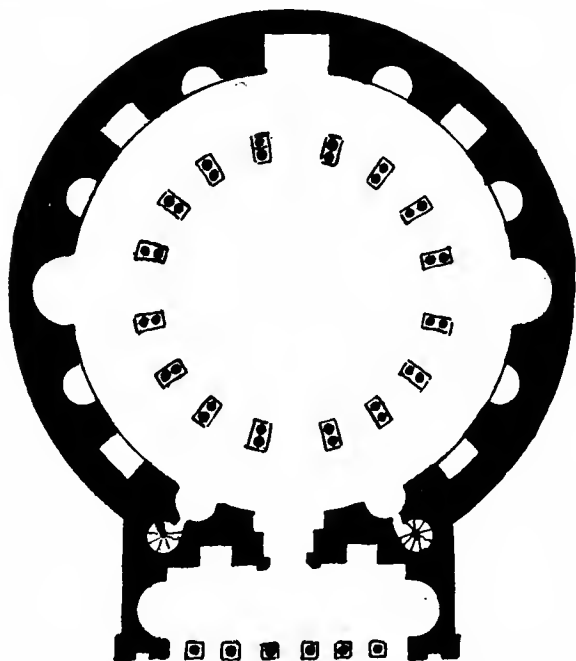

FIG. 9. Plan of Sta. Constantia, Rome, from a drawing in the Soane Museum, made *c.* 1512.

in which were subjects from the old and new Laws. In the thick outer wall there is an altar recess opposite the door, and apsidal niches to the north and south. Before the altar recess a small domical compartment interrupts the con-

tinuous vault of the aisle. It and the side apses were adorned with subjects in mosaic, and the two side ones still remain. In the small dome, Christ, the Apostles, and two women in white robes, were represented in one group, and opposite, the Lamb and the sheep in front of the Heavenly Jerusalem. In the semi-dome, above the apse on the right, is represented Moses receiving the Old Law, while opposite, on the left, Christ gives the New Law to St. Peter, accompanied by St. Paul. The surfaces of the walls were richly encrusted with marble, the arches were plated with marble, and around the tambour of the dome ran a band of *opus sectile*, representing, by a juxtaposition of different marbles, a cornice. The mosaics of the small apses are so different in spirit from the rest that for long it was thought that they must be considerably later, possibly of the sixth century; but there is now a general consensus that they are contemporary with the rest. In the two apses is already found a mystic sentiment with a developed code of symbolism. Christ giving the Law stands on the mount above the four gushing streams, at His feet are the faithful sheep, and right and left appear Bethlehem and Jerusalem. He gives a roll inscribed, "DOMINUS PACEM DAT." In the other mosaic, God the Father is seated on an Orb, and the field is filled by great palm-trees. In the destroyed mosaic of the little cupola the two women clothed in white robes were the Churches of the Gentiles and of the Circumcision. In the magnificent apse-mosaic of Sta. Pudentiana similar figures appear, and in Sta. Sabina (c. 430), two figures which stand on either hand of a dedicatory inscription are named "ECCLESIA EX GENTIBUS" and "ECCLESIA EX CIRCUMCISIONE."

Of the time directly following the first age of church building there must be scores of ruins and foundations, the little church not long ago discovered at Silchester in the distant province of Britain being one. Fig. 10 is

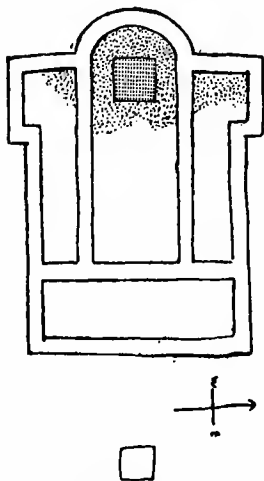

FIG. 10. Early Christian Church at Silchester.

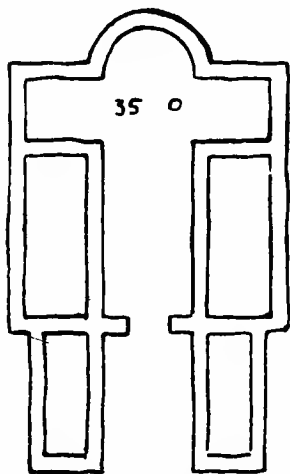

FIG. 11. Early Christian Church, Jataghan, Asia Minor.

its plan; Fig. 11 from Asia Minor may be compared with it.

All knowledge of Constantine's churches in his new capital on the Bosphorus is lost, and those which were built by his direction over the holy sites in and about Jerusalem are little more than a memory.

His buildings at the Holy Sepulchre were erected in ten years from 326. They have suffered so much from violence and change that little of the original work

remains. The rock sepulchre, however, is still partly surrounded by an arcade and a wall which every one admits represents the Constantinian work, and this stands to the west of more recent buildings. The three niches in the circular wall may be compared with those of Sta. Constantia above, and with St. Theodore, also in Rome. Although so early it seems to me that in all these cases

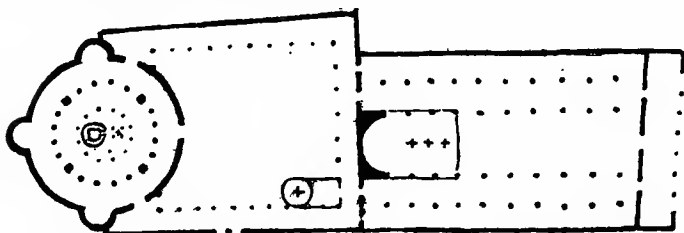

FIG. 12. Suggested plan of the Churches of the Holy Sepulchre, Jerusalem, as built by Constantine.

the intention was to give something of the cross form to these circular buildings. Compare the cruciform nimbus of Fig. 1. Eusebius says that Constantine (1) decorated the Holy Tomb as the head of all, with columns and ornaments. (2) Then came a large space with porticoes on three sides. (3) The side which faced the grotto, that is, the east side, was formed by the basilica, large and high; the interior was encrusted with coloured marbles, the ceiling was carved and gilded, and the roof was covered with lead. (4) Along all the length of the basilica were two colonnades on each side, the first rows, columns, and those behind, square pillars; three doors opened to the east. (5) Opposite the doors in the end of the basilica was the hemisphere, the *head of all*, which rose as high as

the roof of the church, and was surrounded by twelve columns, the number of the Apostles, the summits of which were ornamented with great bowls of silver offered by the Emperor to his God. (6) Then, before the entrance of the Temple, was an atrium, surrounded by porticoes with a fore-gate against the public street.

A large body of commentary on the text (of which this is a summary) exists, the most recent contribution being an accurate survey of all the existing buildings either above or below the surface, by Mommert; and criticisms by Strzygowski on the reconstruction proposed by the former. Mommert substantially follows De Vogüé in understanding that practically one large building is meant, the open space being directly above the rock sepulchre.

His critic, however, separates the parts into a rotunda, an intermediate court, and a basilica, but does not work the scheme out with any detail. Arculph, in the seventh century, as is well known, left a rough plan showing a similar arrangement; but it has been supposed that, as Constantine's buildings had been more or less destroyed by the Persians in the meantime, this need not represent the original disposition. The account, however,



FIG. 13. The Churches of the Holy Sepulchre, from the Madaba mosaic.

given of the original buildings by St. Silvia clearly shows that the "Resurrection" (the Holy Sepulchre) was separated from the "Great Church" by a court (*see* Fig. 12).

It has been assumed, I think by all writers, that Eusebius's "hemi-sphere" was the apse of the Basilica, but it was pointed out to me by my friend, Harold Swainson, that the word "hemisphere" is used by the Silentary for the *dome* of Sta. Sophia, Constantinople, and also by Agathias and Evagrius; and it must be supposed that the same word here has the same meaning. Now, if we follow again the clauses of the description, it seems possible that Eusebius, having described the interior of the Basilica and reached the three eastern doors, turns back again to the "head of all," that is, the Rotunda of the Resurrection, where was, he says, this hemi-sphere. Moreover, it was surrounded by the twelve columns bearing silver bowls, "offered by the Emperor to his God," which might well be understood to form an inner enclosure to the Tomb itself; such an enclosure as was customary in circular churches. For instance, the central point of the Church of the Ascension was, says Arculph, surrounded by a circular bronze screen as high as a man, having a great lamp hanging over it. The silver bowls on the twelve columns mentioned above may very likely have been for lamps. St. Silvia, speaking of the services in the Anastasis, tells us that the Bishop withdrew "within the rails" or "within the chancels." From the Breviary, it appears that the marble pillars and silver bowls were in the Basilica, and if this is accepted the evidence is best satisfied by supposing that the apse was covered by a *dome*, half of which rested on the apse wall, and the other half on

arches and piers, or it might be something like the Church at Spoleto, but the Breviary may copy Eusebius.

Strzygowski shows that the beautiful sculptured cornices of the south wall of the present buildings are Constantinian, and he believes that the wall which they adorn is also original. It is true that the cornices fit perfectly to the masonry—but so, apparently, do the Romanesque doors and windows, and the antiquity of the wall does not seem proved. As to the entrance doors facing the east, there does not seem to be any doubt; a rough representation of the buildings was not long ago found on a mosaic floor at Madeba (Fig. 13), which shows the three doors, a plain roof, and a rotunda appearing behind. Some remnants of the eastern portico seem still to exist.

One of the best restorations which have been made is that given in the *Quarterly Review* for 1899. One point that Strzygowski seems to have overlooked in his plan* is that the intermediate court must have been large enough to contain the supposed site of Golgotha, as we learn from St. Silvia, and as Arculph shows. The original form of the central sepulchre proper as adorned

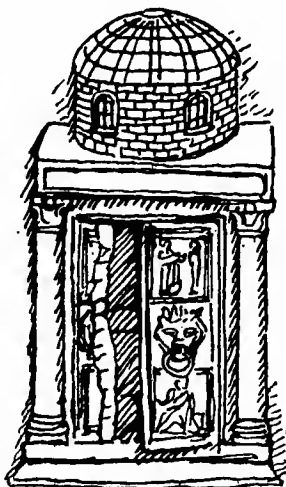

FIG. 14. The Tomb chamber in the Rotunda of the Holy Sepulchre, from a fifth century ivory at the British Museum.

* See "Orient oder Rom."

by Constantine is shown to us on several early ivories, probably the best of which is one of the fifth century in the British Museum (*see* Fig. 14). It consisted of

a chamber, with a dome above, following the tradition of such a tomb as that called Absalom's at Jerusalem.

Of the life which animated the Church of the Holy Sepulchre, the pilgrim, St. Silvia, gives a most lively and detailed account as she follows day by day the processions and services of an Easter week in the fifth century. "Every day before cock-crow all the doors of the Anastasis are opened, and from that hour to daybreak hymns and antiphons are sung."

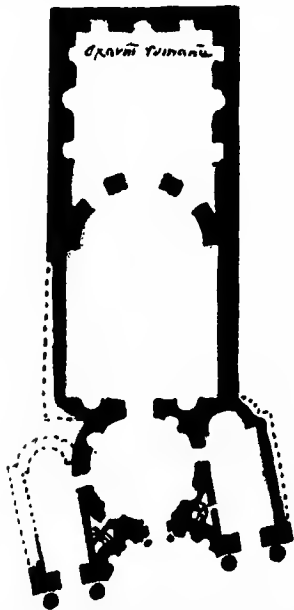

FIG. 15. Roman temples altered into the church of SS. Cosmo and Damian in the sixth century.

A great number of temples were transformed into churches. The Parthenon itself became a church and at Baalbec a fine basilica was built in the courtyard of the temple. The

Pantheon was consecrated in the seventh century. Another interesting Roman example is the round temple of Romulus, built *c.* 312, which together with the adjoining *templum sacrae urbis*, built in A.D. 78, became, *c.* 530, the church of SS. Cosmo and Damian. A

drawing by Conero in the Soane Museum best preserves the form of the church. A door was cut between the round and oblong temples, and the latter was sub-divided by a wall bent into an apse which was pierced by three openings (*see* Fig. 15). A third remarkable church in Rome, San Stefano Rotunda, is held by several writers to have been a Roman Macellum, or Market Hall. It has existed as a church since the fifth century. One of the noblest of churches in scale and form is San Lorenzo, Milan, of which the origin is still uncertain. Of recent writers Dehio and also Kraus consider it to have been a civic building, while Strzygowski holds that it is an Ambrosian church. The church certainly stands in direct relation to the magnificent portico, and the plan resembles a hall in Hadrian's villa. On the other hand, its plan is cruciform, and has a good deal of likeness to that of the great mosque at Adrianople—which Salzenberg and Choisy take to have been an early church—and to the seventh century Armenian church of St. Gregory recently discovered at Etschmiadsin.*

Altogether the late Roman and Early Christian schools are of great importance, and in building especially lie very close to a theoretical central stem of architecture from which the more specialised schools have diverged. The freedom of late Roman building-art is hardly yet fully recognised: even the pointed arch was made use of.†

* *See* Fig. 37.

† *See* the Bridge of Severus, illustrated in Hogarth's "Levant."

CHAPTER II

CONSTANTINOPLE, RAVENNA, AND THE AGE OF JUSTINIAN

NEARLY all the buildings erected in Constantinople during the time of transition to the perfected Byzantine style of Justinian's day have been destroyed. It is clear, however, that the authority of the Roman style had been entirely abrogated, and that a way had been opened up for free experiment once more. In some of the remarkable buildings of Syria, for instance, stone construction was reduced to the mere elements of square posts, lintels, arches, slabs, and the rest; all well devised and wrought, but entirely free from the dead hand in "proportion" and "decoration." This work, however, while germane to Byzantine work, is not properly to be classed as such. It is rather a separate school, which might as already said be called Hellenesque; while the term Byzantine should be reserved for the style we shall endeavour to describe, the style which was developed to its highest point in Constantinople during the reign of Justinian, and to work directly derived from that school.

Vast stores of recently acquired facts gathered from explorations in North Africa, where the remains of more



RAVENNA. CAPITAL BEARING MONOGRAM OF THEODORIC (*See p. 41*)

Face p. 32

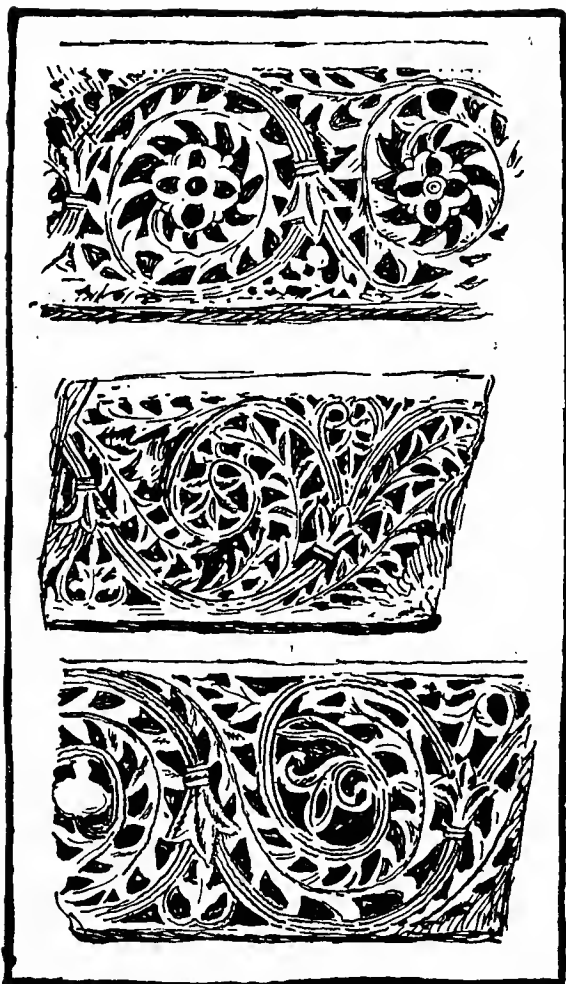

FIG. 16. Stone friezes of fourth or fifth century in the Cairo Museum, after Strzygowski. There are similar fragments in the British Museum.

than a hundred early churches have been found, and from

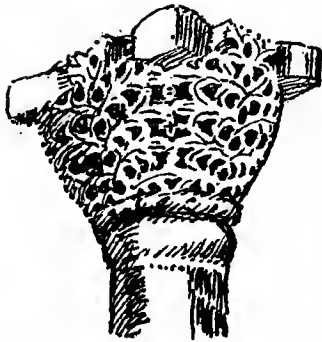

FIG. 17. Stone Capital with palm-branch carving, from Old Cairo, fifth century (?).

Byzantinestyle, which are probably not later than the fifth century (Fig. 16). A capital of the same material, found in old Cairo and purchased for the Berlin Museum (no one in England cares for early Christian objects), is of remarkable interest as being obviously allied in its decoration to the great capitals of

Asia Minor, Syria, and Egypt, are hardly yet to be seen in due perspective. For the decorative side of "Hellenesque" architecture important data have been published by Strzygowski in his catalogue of Coptic works in the Cairo Museum, and in his tract on Aachen. At Cairo there are several fragments of carved friezes of local limestone in a free,



FIG. 18. Ivory panel in the Cairo Museum, slightly restored.



Sebah

CONSTANTINOPLE. STA. SOPHIA. CAPITALS, ETC.

Face p. 34

Santa Sophia itself. It was certainly of local workmanship, and it would be desirable to determine whether the type originated in Constantinople or in Egypt. As to this, it may be noticed that the palm-foliage with which it is decorated is more closely related to such work as that shown in Fig. 16 than to any Constantinople work; and

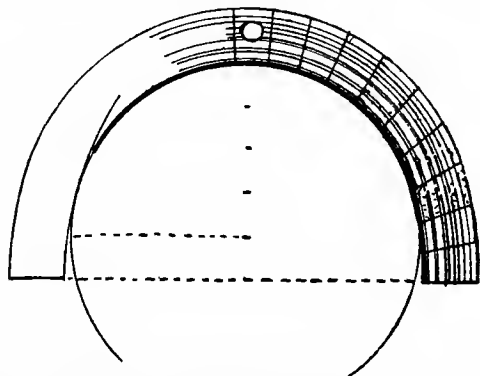

FIG. 19. Diagram of Syrian arch-form from church of St. Simeon, sixth century.

the likelihood seems to be that this is an Egypto-Hellenesque type (Fig. 17 and Plate 5).

Alexandria was the great school of, and mart for, ivory-carving; and many of the decorative ideas developed there were easily distributed over Christendom. Fig. 18 is a slightly restored diagram of an ivory panel in the Cairo Museum which might pass for the representation of a marble from Constantinople or Ravenna. I give also in this place a diagram (Fig. 19) of the characteristic form of Syrian Arch, taken from a photograph of St.

Simeon's Church (sixth century). Arches of similar form are found in Egypt, sometimes of stone, as at the White Monastery, and more frequently of brick, and it seems clear that this form was first developed in brick construction as an easy expedient, and only adopted in stone when the eye had become used to it. Altogether, the share of Egypt in the transformation of art was probably of great importance.*

In Fig. 20 is represented a fine mosaic pavement from Carthage, now in the British Museum, probably of the fourth or fifth century, and certainly Christian. It shows interlacing jets of water rising from chalice-shaped fountains; in the interspaces are peacocks, and in one place a partridge, both Christian symbols; the four streams from which stags drink, flowing from the sacred mount, fill another space. This should be compared with the mosaic from the Baptistery at Salona given by Garrucci, which is explained by the inscribed verse, "As the hart panteth after the water brooks," &c.

In Constantinople itself, the construction for the most part was developed out of the use of brickwork walls and vaults, and marble masonry. The marble, a beautiful coarse white variety, was found near at hand in the island of Proconnesus. The most characteristic constructive method is the concretion of brickwork. The bricks are thin "Roman tiles," and the mortar forms about half of the mass. Marble is used for isolated monolithic columns, and for lintels and door-jambs. All is pure construction, for in no system has the functional structure, the bones

* A good account of the two fine mid-fifth century churches of the White and Red Monasteries has been published by Bock, 1901.

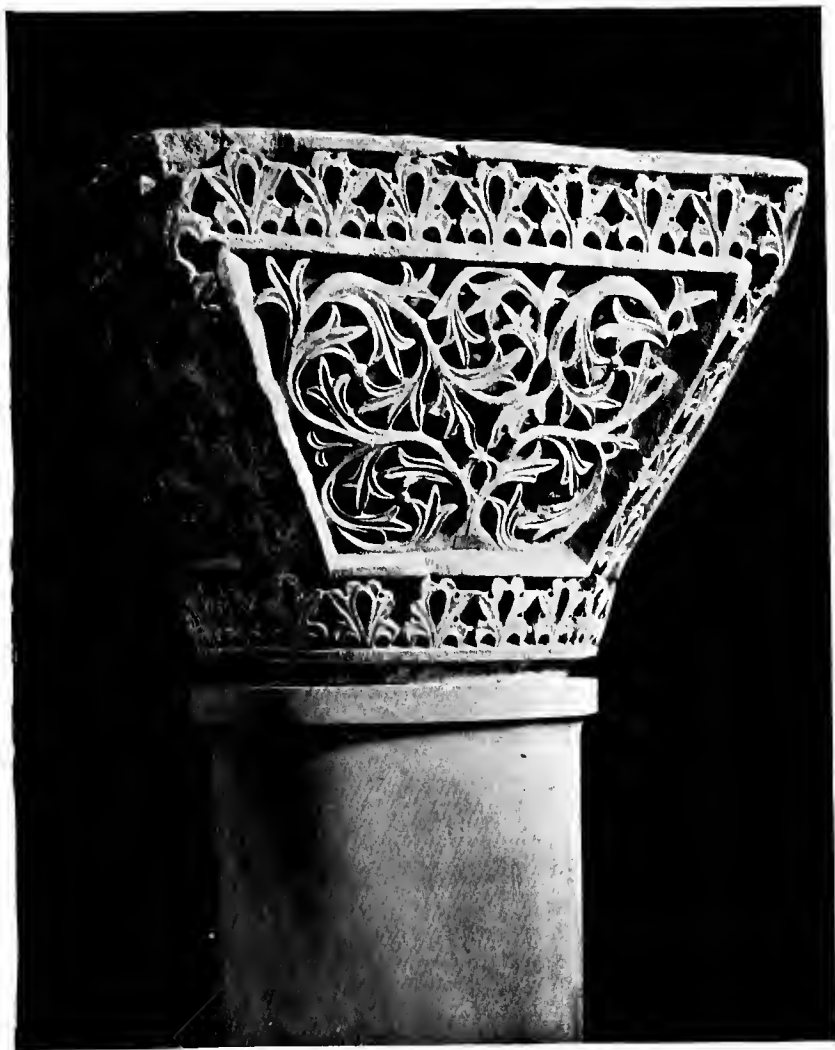

RAVENNA. IMPOST-CAPITAL. SIXTH CENTURY

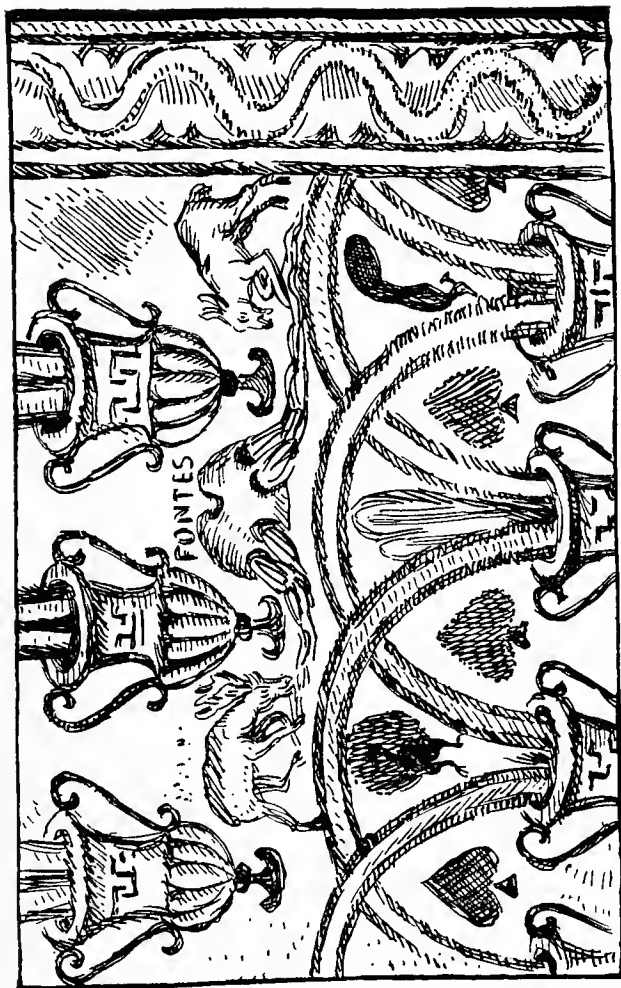

FIG. 20. Mosaic pavement from Carthage, in the British Museum, fifth century (?).

and muscle of a building, been more sufficient unto itself.

The chief factor of Byzantine building is domical vaulting, the domes or vaults being shells of brick-concrete which are homogeneous with the walls, wide-spreading rather than high, and covered on the outside with lead. The concentric type of plan naturally resulted from the use of the dome, the parts around the middle spaces being so disposed as to spread the weight of the central dome over a wide area, and gradually diminishing in height. This resulted in greater unity of construction than is found in any other highly developed buildings.

“Decoration” was conceived of as the covering over, but not disguising, of this frame, with a continuous and beautiful surface-skin obtained by the application of thin sheets of vari-coloured marbles and of glittering mosaic.

In the interiors, where mosaic was used, it was carried continuously over the vaults and arches without any separating ribs, the re-entering and salient angles being rounded to take the tesserae.

The exteriors of these churches were comparatively plain, save for the marble pillars and carved cornice of the atrium, but some of them had at least their western fronts covered with mosaic. Clavigo, a Spanish ambassador, who visited Constantinople in 1400, describes the church of St. Mary of the Fountain as having its exterior “all richly worked in gold, azure, and other colours.”

The column-capitals of Justinian’s time have never been matched for beauty. New types were then in use, together with modified forms of older ones in great variety. The new capitals were made by reverting to first principles of

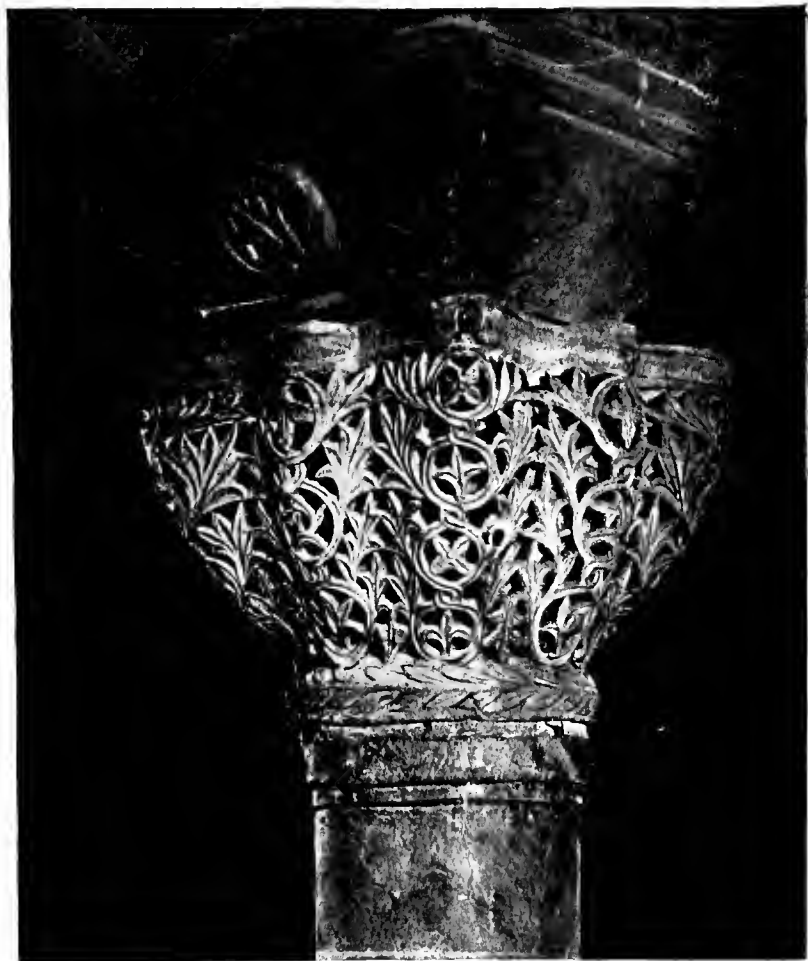

RAVENNA. IMPOST-CAPITAL FROM S. VITALE

masonry. If a cubical block of marble be placed on a round shaft the diameter of which is less than a side of the square, and if now all the surplus material be cut away at the bottom so that the large square above gradually changes and diminishes into the circle beneath, we get the broad form of the new "Impost Capitals." Over this general form was designed a network of evenly distributed, sharply serrated leafage, and the ground was deeply sunk, and in places entirely undercut, so that a veil of marble stood free of the background. (Plates 6-8.)

There were many varieties of the Impost Capital, which are found again and again. Thus those of the great order of Sta. Sophia, which in some respects stand apart from all others, are adorned with what, for distinction, we may call palm-branches. Exactly similar foliage is found on capitals at Parenzo and on one from Pomposa at Ravenna. (Compare Fig. 17 and Pl. 9.)

The variety which Ruskin named, from some at St. Mark's, the "lily capital," has been found in Constantinople and many other places. The finest example known is preserved in the Cairo Museum;* it is wrought in the marble of Constantinople. At San Vitale, Ravenna, the whole ground story of the central area has capitals of this type. On the four sides of these capitals, in square panels, are

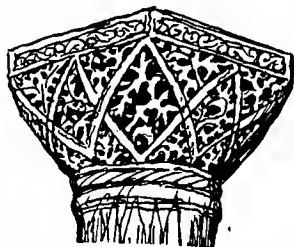

FIG. 21. Byzantine capital of sixth century, now in mosque of Kerouan, North Africa.

* See Strzy. *Copt. Cat.* for figure and full list.

BASKET CAPITALS

carved tree-like forms simplified almost to a fleur-de-lis; the rest of the capital is occupied by interlacing basket work. The whole is strangely beautiful, and yet seems to call for some explanation of origin and meaning. The figure is a foliated T cross, which at the same time has some resemblance to the lotus. It seems probable, as Strzygowski



FIG. 22. Byzantine basket-capital found in Rome, from Piranesi.

suggests, that this type was of Egyptian origin. An example of this kind of capital has recently been found in the Mosque of Kerouan, not far from the ancient Carthage. Another found at the same place has the carved ornament arranged within a series of interlacing lozenges (Fig. 21). Similar capitals to these last are found at Sta. Sophia, Parenzo, Jerusalem, and other places. The "bird and basket" type of capital found in Constantinople has its lower part carved with open interlacing bands like a

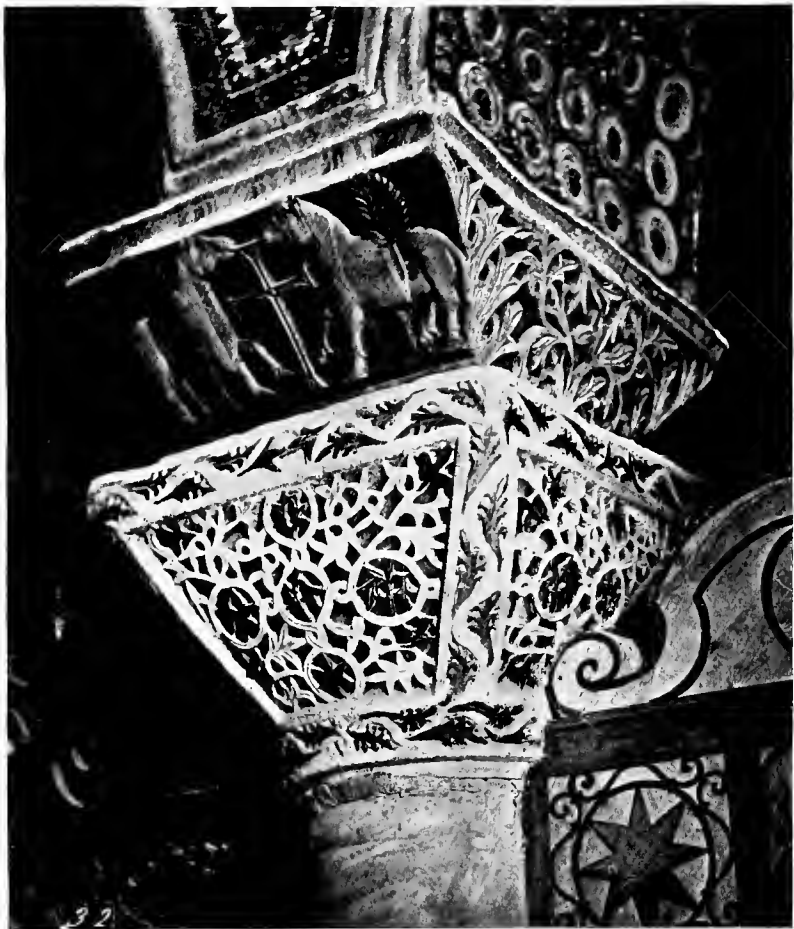

RAVENNA. IMPOST-CAPITAL FROM S. VITALE

circular basket, and on the rim of this four doves are perched which fill the angles under the abacus. I give a figure after Piranesi of a capital of this kind found in Rome (Fig. 22). "Byzantine-Corinthian" capitals appear

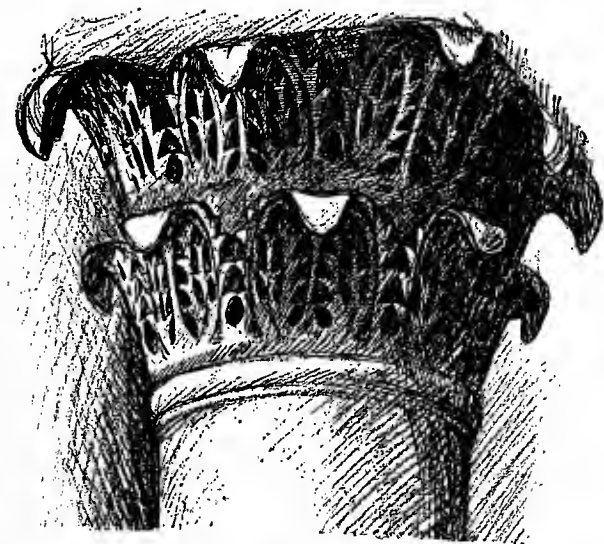

FIG. 23. Capital from a church in Isauria, Asia Minor.

in a great variety of forms. Of these I give a beautiful example from a church in Isauria, Asia Minor (Fig. 23). Capitals at Parenzo and Ravenna are very similar in the much-recurved tips of the acanthus-leaves.

Still another type is the "wind-blown acanthus," in which the leafage is twisted to the side instead of drooping. I give a fine example from Ravenna, which belonged to

the basilica of Hercules, built by Theodoric, whose monogram it bears. (Pl. 4.) The identity of the form and material of capitals found in many places widely apart can only be accounted for by supposing that they were all wrought at one centre, and that centre must be Constantinople.

Byzantine capitals usually have impost-blocks above them, from which the arches spring. An early example is to be found in the remnant of Galla Placidia's church of St. John the Evangelist, Ravenna. Many origins have been suggested for this feature, but its practical utility has not been sufficiently noticed. Classical capitals which bore lintels were relieved of weight on the delicate projecting parts by allowing the lintels to *bear* only above the columns, the rest of the tops of the capitals being slightly lowered. When, in a Byzantine building, *arches* sprang from capitals the imposts of which arches were as big as, or bigger than, the capitals, it was the best expedient to interpose a plain, weight-carrying block, reduced below so as only to rest on the centre of the capital. Moreover, this fell in with the general tendency to "stilt" arches, or even to give them a horseshoe form, which was developed in Syria and Asia Minor. The impost-block was particularly convenient where the wall above the capital was very thick and the arch impost was oblong in plan. (Plates 7 and 8.)

The earliest church still existing in Constantinople is the Basilica of St. John, built about the middle of the fifth century. This is not vaulted, and, except for the freer character of the details in sculpture, is much like a Roman church of the same time. The details, however,

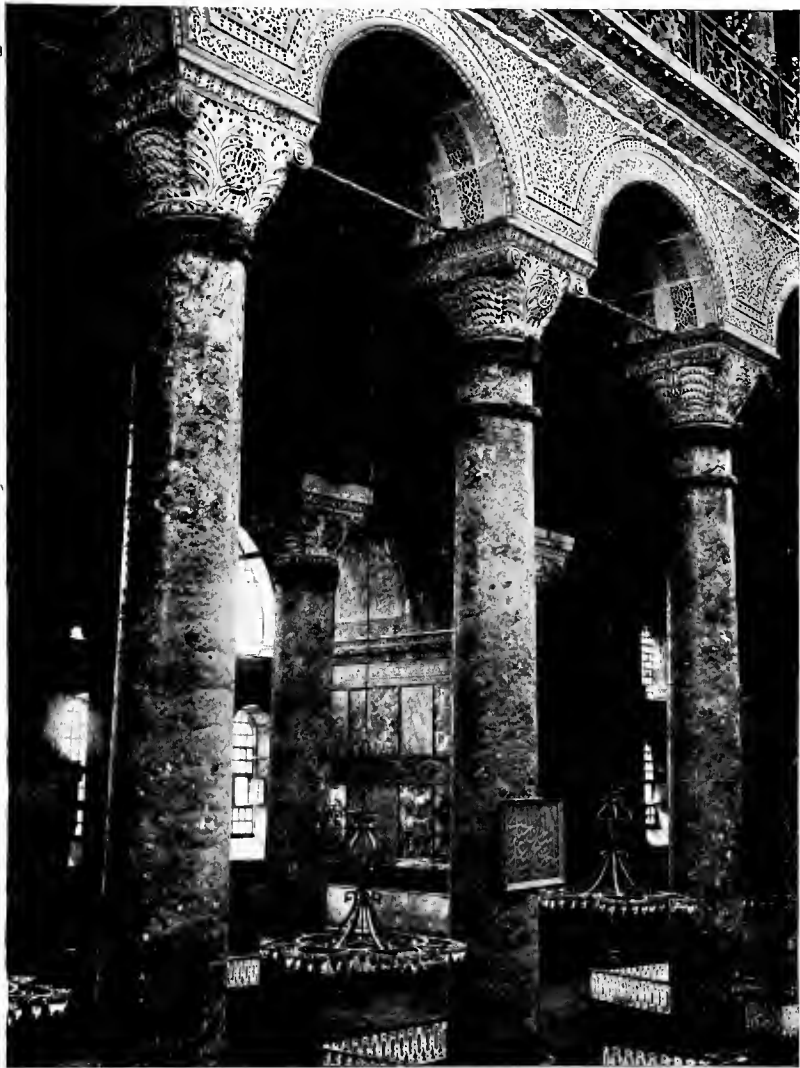

Abdullah

CONSTANTINOPLE. STA. SOPHIA. THE GREAT ORDER OF
THE INTERIOR

show that the Byzantine transformation was well advanced when the portico was built. Sts. Sergius and Bacchus, built by Justinian, about 527, is entirely vaulted, and has all the marks of the developed style. The domed central

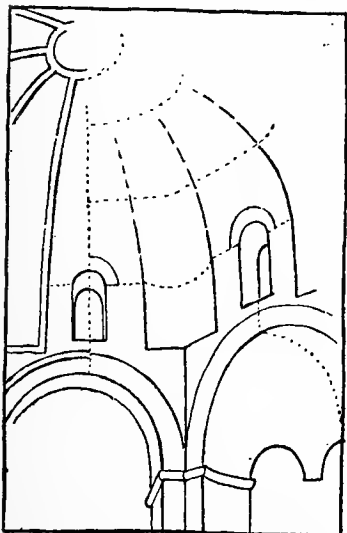

FIG. 24. Diagram showing form of the dome of St. Sergius, Constantinople.



FIG. 25. Plaster rib on the same dome.

area of this church is an octagon standing within a square which encloses an aisle around the octagon, to which the aisle opens between marble columns. At the four intermediate sides of the octagon these columns are not placed in straight lines, but are formed into exedras or apses. This is an extremely beautiful arrangement, enlarging upon the principle we have already seen used

in the "Temple of Minerva Medica" in Rome, but here the dome, instead of being carried by solid work, is entirely supported on open colonnades. The form of the dome is not properly described by Salzenberg or Choisy. It is not spherical nor set on regular pendentives, but, each angle of the octagon being rounded into a niche, the dome springs in sixteen sides, the alternate ones over the angle niches being concave to the interior. On the inside, modelled plastered ribs follow the sixteen divisions and surround the eight arches. This is much disguised with Turkish painting, but is certainly Byzantine. The capitals of the columns, which are of great beauty, bear monograms of Justinian, Basileus, and of Theodora (*see* Fig. 24 and Fig. 25).

The church of Sancta Sophia was begun in 532, and it was dedicated in 537. It is described by two contemporary writers, Procopius, and Paulus the Court poet. In plan it is alone among churches (Fig. 26). It may be conceived as formed by dividing St. Sergius in two from north to south, and removing the two halves from one another by the distance of the width of the dome (now become two semi-domes), then, above the square void, raising a still higher dome supported right and left by ranges of arcades, as in a basilica. The dome is wide rather than high, and the sense of amplitude surpasses that offered by any other building in the world. In buildings of the basilican type size is obtained by repetition of a unit bay, but here the vast church is but one chamber surrounded by double tiers of aisles. The columns are of porphyry and verde antique, the carved capitals of white marble, the vaults were all encrusted with golden mosaics. The walls are shected

over with thin slabs of precious marbles, as the poet says,

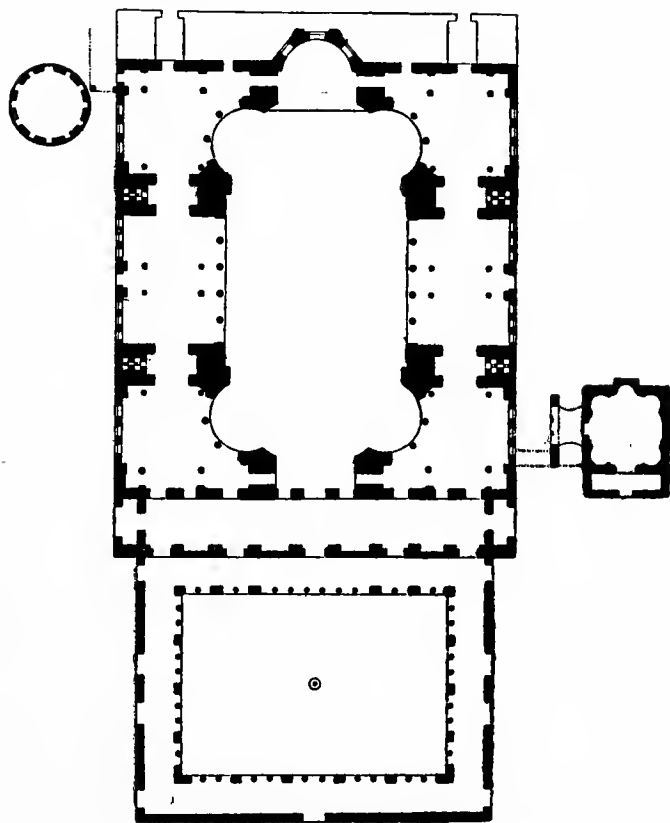

FIG. 26. Plan of Sta. Sophia, Constantinople.

“fresh green as the sea, or emerald stone; or, again, like blue cornflowers in grass, with, here and there, a drift of

fallen snow; there is wealth of porphyry, too, powdered with bright stars." The iconostasis was of silver and the altar of gold, under a silver canopy. The ambo, which stood forward, in the middle of the church, was of silver, ivory, and precious marbles.

These, of course, have all disappeared, as also has the atrium, which enclosed a space in front of the western doors, with a fountain in the midst. Paulus, describing the opening ceremony after the repairs of 558, writes: "At last the holy morn had come, and the great door groaned on its hinges, as the sun lit up the glories of the temple. And when the first gleam of rosy light leapt from arch to arch all the princes and people hymned their songs of praise, and it seemed as if the mighty arches were set in Heaven. Whoever raises his eyes to the beauteous firmament of the roof scarce dares to gaze on its rounded expanse sprinkled with stars, but turns to the fresh green marble below; seeming, as it were, to see flower-bordered streams, or the deep peace of summer sea broken by the plashing oars of spray-girt ship." Two interesting contributions to the study of Sta. Sophia have lately been made, by Antoniades in a series of articles in *Knowledge* (1903), and by Preger in the *Byzantinische Zeitschrift* (1901). The latter shows that the account the "Anonymous" gives of the church dates at latest from the tenth century. His description of the floor laid to symbolise the four Paradise streams, the Ambo, the Fountain of the Atrium, &c., must apply to the church as it was before the dome fell in the last quarter of the tenth century. Our own R. Diceto, c. 1180, gives a version of this text in his history.

While Sta. Sophia was being built, a second great church, the Holy Apostles, was begun by Theodora in 536. From the description of Procopius it is well known that this was in the form of a cross covered by five domes.

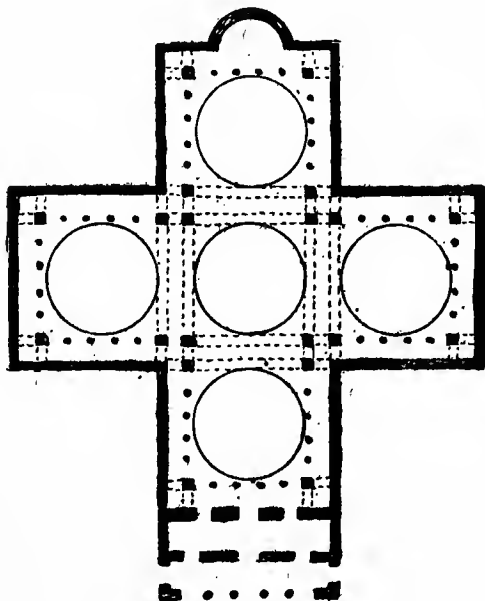

FIG. 27. Approximate plan of the church of the Holy Apostles, Constantinople.

The central dome, he says, was pierced with windows, the sanctuary being beneath this, at the middle point of the church. In 1896 there was discovered in a convent on Mount Athos a poem describing this church, written about 900, by Constantine of Rhodes. He first refers to the

commanding position of the cross-shaped church on the fourth hill of the city, and then tells us that the master first designed a square, around which were added four arms, each having a double storey of columns.

The central dome stood above four square pillars, and four pillars, standing in squares repeated four times, supported the other four domes. There were also forty-eight columns to each storey, like double "rows of body guards." Twelve, the number of the apostles, in each of the four limbs, enclosed three sides, outside which was an aisle running continuously around the church.

In the interior, bands of brightly coloured marble surrounded the walls "like a wreath." The domes and arches and the upper part of the walls were covered with mosaic; in the centre was Christ, the Virgin, and the Apostles (possibly the Ascension, as in the St. Mark's central dome); there were besides several other scenes from the life of Christ—the Annunciation, Nativity, and Coming of the Kings, the Presentation in the Temple, Baptism, and Transfiguration—most of which also occur in St. Mark's.

The description can be well explained by reference to the plan of St. Mark's, which, tradition says, was derived from that of the Church of the Apostles.

The wall of the aisle surrounding the piers and columns which upheld the domes formed a strong outer support. There was a narthex and an atrium, but an eastern apse is doubtful. (*See Fig. 27 from the Byzantinische Zeitschrift.**)

A Byzantine church usually stood apart in a close, surrounded by trees. It was entered through a cloistered

* For the church of S. Irene see Appendix.

forecourt, in the midst of which stood the phiale, or fountain. Across the front of the church stretched the narthex, forming its vestibule. The apse, and usually a short square space in front of it, shut off from the body of the church by a screen, was the bema. Around the curved wall were banks of raised seats, the synthronon, in the midst of which, against the wall, stood the patriarch's throne. In front of the throne was the altar, protected by a canopy upheld on four columns. The bema was entered by the holy doors in the iconostasis. In front of this screen was the solea, a space set apart for the choir of singers. And on the middle axis rose the ambo, with stairs to it both to the east and west.

Choisy has lately restated what was the opinion of R. de Fleury—that the iconostasis of Sta. Sophia stretched across the chord of the great eastern hemicycle; but this would give a screen of a hundred feet long, and the position is not in accordance with the evidence still to be found in St. Sergius, nor with the text of the Silentiary's poem. Still more lately the question has been re-examined by M. Antoniadès, whose view is that the hemicycle was not included in the bema.

In Sta. Sophia and other churches of the first rank, the interior walls below were entirely sheeted with marble, and, above, they and the dome were overlaid with mosaics on a gold ground. Lesser churches were painted in sweet, gay colours. Painted walls and vaults, as, for instance, those in the parecclesia of the Chora church in Constantinople, are sometimes almost more beautiful than the mosaic churches. Paintings or mosaics alike cover the whole surface continuously. The former harmonise in fair, pearly

hues, but the more splendid mosaics fill the whole reservoir of air with a golden haze. Columns of polished porphyry and verde antique in such a setting take a value like jewels. Byzantine mosaics and wall-paintings and, indeed, book-paintings as well, are all alike in the dignity and directness of method, and in the mastery of sweet and grave expression, which characterises them. In a traditional art, as this was, each product has a substance and content to which the greatest individual artists cannot hope to attain. It is the result of organic processes of thought and work. A great artist might make a little advance, a poor artist might stand a little behind, but the work, as a whole, was customary, and was shaped and perfected by a life-experience whose span was centuries. No more fit illuminations for pages of masonry can be conceived than these mosaic figures; in their simple serenity they seem a cloud of witnesses, angels and saints, upon a golden sky.

Outside Constantinople the finest groups of Byzantine churches are to be found in Salonica and Ravenna. At Salonica there are two basilicas, a domed square church, and a domed circular church. St. George, the round church, is 79 feet in diameter, with large niches round about taken out of the wall, which altogether is about 18 feet thick. The dome has a series of remarkable early mosaics of martyrs in attitudes of prayer, who stand before large architectural façades. The church and decorations seem to be of the fifth or even the fourth century. Many of the martyrs figured in the mosaics were soldier-saints, and it seems probable, as the mosaic over the



RAVENNA. MOSAICS OF SANT' APOLLINARE NUOVO

opening to the apse is destroyed, that that contained St. George, and that the others were companion warriors. At Ravenna we can very well trace the course of early

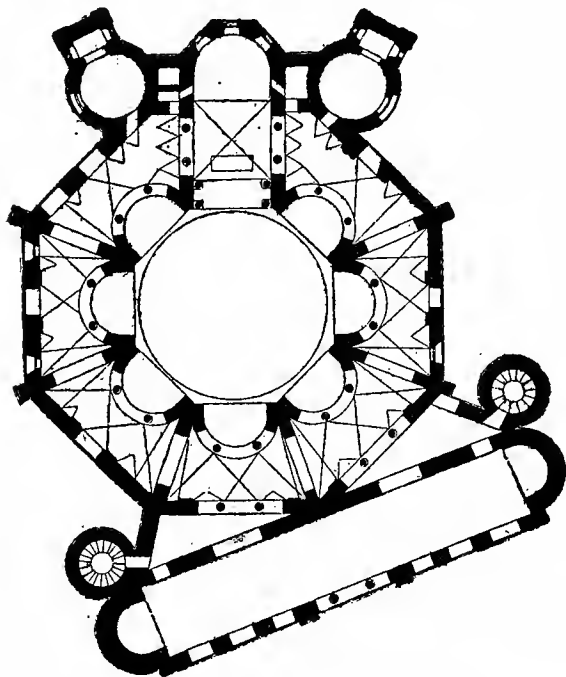

FIG. 28. Plan of St. Vitale, Ravenna.

Byzantine art. Here are a number of monuments which are almost exactly dated, and some of which have preserved the full splendour of their decorations. Of the first period we have the work executed for Galla Placidia, the daughter of Theodosius the Great and

sister of Honorius. Her tomb chapel remains nearly perfect to this day. It is a small cruciform building with a domical vault over the centre, roofed as a tower on the exterior. The four vaults of the arms of the cross spring at about five feet from the pavement. Above this height the vaults and walls are entirely covered with mosaic, and below, the walls are plated with marble. The cupola is built of earthenware amphoræ set into each other and imbedded in concrete. The mosaics have a blue ground on which, at the centre of the cupola, is a large cross set in a heaven of gold stars. Below are the four symbols of the Evangelists, and, on the walls, are figures. This building was completed before 450. Within the next eight or ten years the orthodox Baptistery was built and decorated by Bishop Neon. It is a tall octagonal structure, domed on the inside and encrusted with blue-ground mosaics, marbles and stucco reliefs.

The next period is that of Theodoric, to which belong the great basilica of Sant' Apollinare Nuovo (*c.* 526), part of the octagonal church of San Vitale, the Mausoleum of Theodoric (*c.* 520), the Baptistery of the Arians (*c.* 526), and other less perfect buildings.

Sant' Apollinare Nuovo has an arcade of a dozen bays supported on cipollino columns; above this arcade is a long procession, in mosaic, of white-robed saints, from end to end. These were not wrought until between 556 and 569. On the left, at the east, the Virgin sits on a star-embroidered throne surrounded by four archangels. To her come the three kings led by the star and bearing gifts, and they are followed by virgin saints, each one of whom bears a crown, and between each pair rises a palm-



RAVENNA. MOSAIC PORTRAIT OF JUSTINIAN

tree. At the west end is a city with a port and ships; over its gate, from which the saints seem to issue, is written: "CIVITAS CLASSIS" (the port of Ravenna). On the right-hand side of the nave, and opposite the Virgin, is Christ and four angels, and then a procession of saints led by St. Martin. These seem to come out from a representation of Ravenna itself at the west end. A magnificent palace is here shown, and over the city gate appear the letters "CIVITAS RAVEN . ." These bands of mosaics are about ten feet high. The idea of this procession of all saints reminds us of the Panathenaic frieze wrought a thousand years before around another temple by other Greek hands.* (Plate 10.)

The Mausoleum of Theodoric is a circular building on the outside, and covered by a low dome, or rather lid, of one stone about thirty-three feet in diameter. Upright projections like enormous handles are left on the upper side surrounding the dome, and on these are engraved the names of the Apostles. These curious features appear to be imitations of small abutting arches like those which surround the dome at Sta. Sophia, Salonica. The height of the building is divided into two stages—the lower one is the larger, and was surrounded above by an arcaded passage. Choisy points out that it has stylistic affinities with Syrian work, and Strzygowski, calling to mind that several of the early bishops of Ravenna were Syrians, thinks that Ravenna in much derived from Syria, especially from Antioch. The capping of a single stone with its orna-

* These mosaics have been restored. Large portions were missing when the plates given by Garrucci were drawn. The two city subjects belong to Theodoric's time.

ment, which resembles goldsmiths' work, and was doubtless decorated with gilding and colour, was possibly intended to suggest a crown.

San Vitale is very similar in its plan to Sts. Sergius and Bacchus in Constantinople; but here the central space has eight exedras instead of four; that is to say, it has an octo-foil form. It is usually said to have been built between 525 and 534; the mosaics are later, and it was not consecrated until 547. It is said that Ecclesius the bishop handed the building over to Julius Argentarius about 526, who finished and decorated it. The capitals of the choir bear the monogram of Julius, and some inscriptions have been found, one of which says he built, ornamented and dedicated the church, and another that he perfected it. The capitals of the body of the church have monograms, which have been explained in many ways, some of which are quite impossible. Strzygowski in a recent study of the subject says he can get no other result than NEON EPIS[copus]. This is startling, as Neon ruled the See from 449 to 458. See monogram 2, Fig. 29; Garrucci gives 3 as the monogram of Neon from the Baptistery, and some others are here added for comparison. It is to be noted that some of the columns signed with monogram 3 come *above* those signed by Julius. Altogether the difficulties in accepting the reading Neon seem too great. The monogram may be read Petrus Episcopus as well as Neon. In the centre of the apse-mosaic, Christ is seated on an orb, beneath which spring the four rivers, which flow away through fields of lilies. On one side a white-robed archangel presents San Vitale, to whom Christ extends a crown; on the other, Ecclesius, the bishop, is led up, and presents



RAVENNA. MOSAIC PORTRAIT OF THEODORA

Face p. 54

a model of the church. On one wall is a group consisting of the Emperor Justinian and the Bishop Maximian, with attendant clergy and soldiers. On the other side is Theodora with her Court ladies; her headdress glitters with jewels. (Plates 11 and 12.) In these mosaics mother-of-pearl is

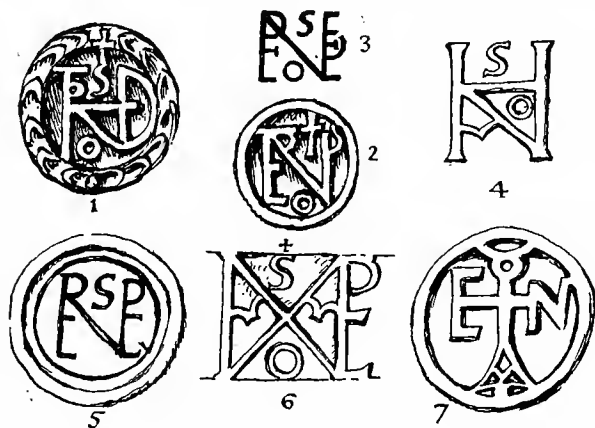

FIG. 29. Monograms: (1) Theodoric from Basilica of Hercules; (2) Neon Eps (?) from S. Vitale; (3) Neon from Baptistery, *see* Garrucci; (4) Iohannes from S. Clemente, Rome; (5) Euphrasius Eps. from Parenzo; (6) Maximian Episcopus, Ravenna; (7) ANΔPEOV (?), Ravenna.

used, and in the emperor's and empress's jewels are set real stones and pearls. The marble capitals and pierced screens are of finest Constantinople work. The soffits of the arches have patterns in modelled plaster. The mosaics of San Vitale, and the long processions of Sant' Apollinare Nuovo, are directly the work of Justinian, who repossessed himself of Ravenna in 539. The problems raised by

St. Vitale are of great interest in the history of Art. In 1903 the foundations of an Atrium were found squaring with the Narthex which stands obliquely to the church. It has also been recently shown that the vaults of the aisle of the Rotunda were built after 539.

Sant' Apollinare in Classe, the other great basilica, was built in 534-538, after the death of Theodoric in 526. Here, also, are many beautiful mosaics. In regard to this basilica, R. de Fleury has brought forward a theory that the arcades at a late time have been lifted up bodily for some feet, an equal space being cut out of the wall above, the reason being to raise the floor out of danger of inundation.

At Parenzo there is another basilica of the same age; but, before turning to it, I would just mention the superb ivory bishop's chair at Ravenna, which bears the monogram of Maximian. It was probably wrought in Alexandria, and is the finest existing example of ivory work. (Pl. 13.)

Of Parenzo it is related that it was built from 539 to 543, and was founded with the goodwill of the Emperor Justinian. Here the atrium is intact, and a baptistery is attached to the centre of its west side. The exterior of the west front of the church was covered with mosaics of saints adoring Christ, Who sat amid the seven candlesticks. In the interior there is a fine assortment of capitals of different types, and the ornamental plasterwork of the arches is almost identical with that of Ravenna; in fact, it seems likely that the work was entirely done by the same artists who worked at Ravenna. The apse has preserved its hemicycle of seats, and its walls are covered with beautiful inlays of marble, porphyry, mother-of-pearl,

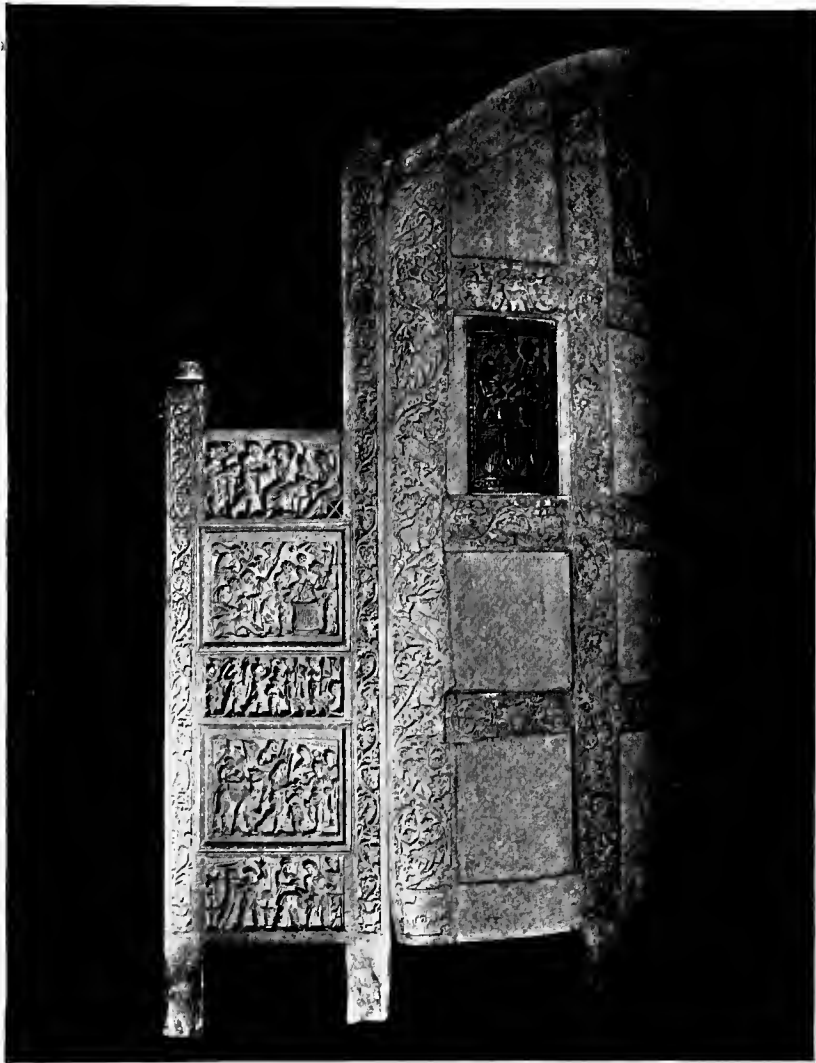

RAVENNA. IVORY THRONE SIXTH CENTURY

and iridescent shells. In the conch of the apse is a mosaic of the Virgin seated, on a background of gold flecked over with rose and azure clouds; on either hand is an angel, and on the left Euphrasius, the bishop, who holds a model of the church, and other figures. Monograms of Euphrasius appear on the capitals and in other parts of the building. Some mosaics of Christ and the Apostles on the front of the triumphal arch, probably of the ninth century, have lately been discovered.

Justinian seems to have been the greatest builder who ever lived. He did not, like Augustus or Nero, merely adorn a city, but his entire empire. An important monument in the East, of which the date is not certain, may here be spoken of. This, the Church of the Nativity at Bethlehem, is, from its associations and the influence it must have exercised, one of the most interesting of the world. It is a five-aisled basilica, crossed by a transept proper, the east, north, and south arms all being terminated by similar apses. An excellent description of it as it appeared in 1484 is given by Felix Fabri. The seventy

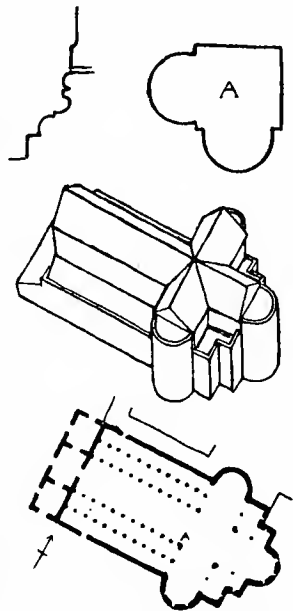

FIG. 30. The Basilica at Bethlehem, with details of the pillars at the crossing.

precious columns of the interior and the marble slabs lining the walls were polished as brightly as a mirror. On the capitals rested beams of wood, above which the walls were adorned with mosaic, with figures from the Old Testament and corresponding figures from the New. "The whole church is either cased with marble or mosaic." The roof is of wood covered with lead. The church is 160 feet long inside, and under the crossing is the famous cave in the rock. It is known from Eusebius that Constantine built a church over this chamber. Eutychius, writing in the tenth century, says that this church, being small, was destroyed and built in a better fashion by Justinian. This account is accompanied by some apparently legendary matter. Justinian, it is said, was dissatisfied by the way his agent had carried out his commands, and had him executed. Procopius, in his history of the works of Justinian, only says that the emperor restored the wall of Bethlehem and the church of the Abbot Joannes in the same place.

Fergusson says that "the choir with its three apses does not seem to be part of the original arrangement, but to have been added by Justinian." De Vogüé, however, is clear as to its being a work built "in one jet," and concludes that the account of Eutychius is to be set aside, and that the basilica is an original work of Constantine. R. de Fleury is of the same opinion.* As to the present church being one work I entirely agree; but I do not believe it to be Constantine's. It is certainly not like

* Of recent writers Kraus holds it to be Constantinian; Enlart that the nave is of the sixth century; Dehio that the nave and east end are of different dates; V. le Duc seems to have held that the whole was a sixth-century work.

Justinian's work in Constantinople, and many stylistic arguments could be urged in favour of both views. But on weighing them I feel that, although it *might* be Justinian's work, it *cannot* be Constantine's. From internal evidence alone, I should be inclined to assign it to an intermediate period, after St. Jerome had made Bethlehem a famous monastic centre. We might expect that Constantine's building would have been a circular martyrion, not a large congregational or monastic basilica; the front faces the west, not the east. The plan is a pronounced cross, and the abaci of the capitals bear crosses within wreaths.

Clermont Ganneau has recently shown that the western façade had a mosaic of the Nativity dating from the time of Justinian. It is said that the Persians under Chosroes, recognising their own national costumes in those of the three kings, forbore to destroy the church. The inner walls were decorated with mosaics until a late period. Inside the gable wall was a great Tree of Jesse; around the choir the New Testament story; and in the nave symbolic buildings standing for the seven great councils. Most of these mosaics were of the twelfth century. A part of the atrium and three entrance doors were also in existence until lately; now only the central door remains.

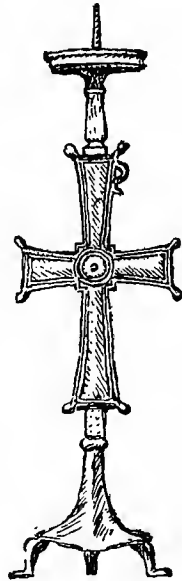

FIG. 31. Byzantine candlestick in the Cairo Museum.

The convent of St. Catherine at Sinai is an undoubted example of a monastery of the time of Justinian. It is a fortified stronghold surrounded by a square of high thick walls. Within, the church is set down obliquely and the interspaces are filled with cells, chapels, stores. The church is basilican, with apse and side chambers. The columns of the interior bear fine capitals, the pavement is covered with marbles, the roof is painted and gilt, and the apse is covered with mosaic. Around the apse is figured the Transfiguration—Christ, Moses and Elias, and below Peter, James and John. Round about in medallions are the Apostles and the Prophets. Upon the vault is the Burning Bush and Mount Sinai, with two figures of Moses, putting off his shoes on one side and on the other carrying the tables of the Law. Above are two angels and two heads in medallions, which the monks say represent Justinian and Theodora. On the right of the apse is the white marble tomb of St. Catherine, ornamented with reliefs, one of which represents two fawns adoring. Behind and below the level of the apse is the more ancient chapel of the Burning Bush. The chief glory of the church is the enamelled door between the narthex and the nave. This door is 8 feet wide and about 14 feet high, and the enamels, are mounted in two panels surrounded by delicately ornamented bronze work. This door is probably the work of the tenth or eleventh century: the mosaics also may be later than the church. Ebers* found on some timbers which had belonged to the roof three Greek inscriptions to the following effect: "For the preservation of our pious King Justinian the Great." "To

* "Durch Goshen zum Sinai."

the memory of our defunct Queen Theodora." "Lord, whom we adore in this place, save Thy servant Stephen, and the architect of this monastery, Ailios, also Nonnas; have pity on them."

This fortified monastery as a whole follows the type of the earlier White and Red Monasteries on the Nile, built about 450.

One of the most extraordinary buildings of the sixth

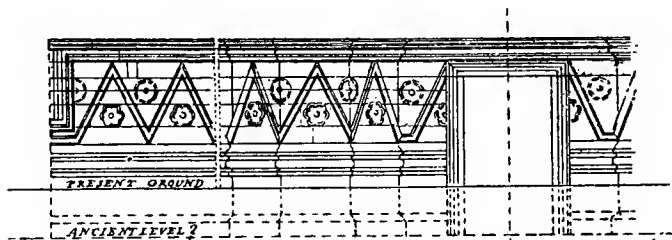

FIG. 32. Diagram of lower storey of the Palace at Mashita in Moab. The whole is elaborately carved with foliage, birds, and beasts.

century is the church of St. Simeon Stylites in Syria. In the centre of a fine octagonal court rose the saint's pillar, and from the four cardinal sides opened as many complete basilican churches, while the intermediate sides of the octagon were occupied by semicircular exedrae.

We must spare a page just to mention the subject of Byzantine palaces. These, it seems, were as typical in their traditional arrangements as the churches. The plans of the Palatine palaces have been recovered, and we have a full record of Diocletian's palace at Spalato. In the East, the wonderful building discovered by Tristram at

Mashita, in Moab, was in a fair state of preservation. This last Fergusson assigned to Chosroes II. (598-628), and Perot and Chipiez agree that the "ornamentation certainly bears the mark of that date."* This, however, I cannot accept; it seems rather to be Byzantine work of the age of Justinian or even slightly earlier. The plan follows the Western type, having a striking resemblance to Spalato. Moreover, Dr. Merrell has shown the untenability of the historic assumption. To account for the Byzantine character it has been said that it might have been built by Greek artists for the Persian conqueror, but we have a record that the palace at Ctesiphon, built by Chosroes I. (531-579) was so built, and in artistic character there is no resemblance between these two buildings. Comparison surely makes it plain that the lovely Mashita work, which has affinities even with Baalbec and Palmyra in the style of the decorations, must be the earlier one. Fig. 32 is a diagram of the lines of the lower part of the façade; this framework is covered and filled with carved adornment. The type of the ornamentation, animals and birds in an elaborate thicket of foliage, is like that of the Ravenna ivory throne. Compare the great triapsidal triclinium of the Palace of Constantinople and also the triclinium of Leo in the Vatican with the great hall here. The plan of the Roman palace at Treves given by Dehio may also be compared with Mashita. Recent excavations have shown that the so-called palace of Theodoric at Ravenna is really a gateway or outlying portion, and probably not earlier than the eighth century.

* Dieulafoi and Gayet also accept this date. See Appendix B.

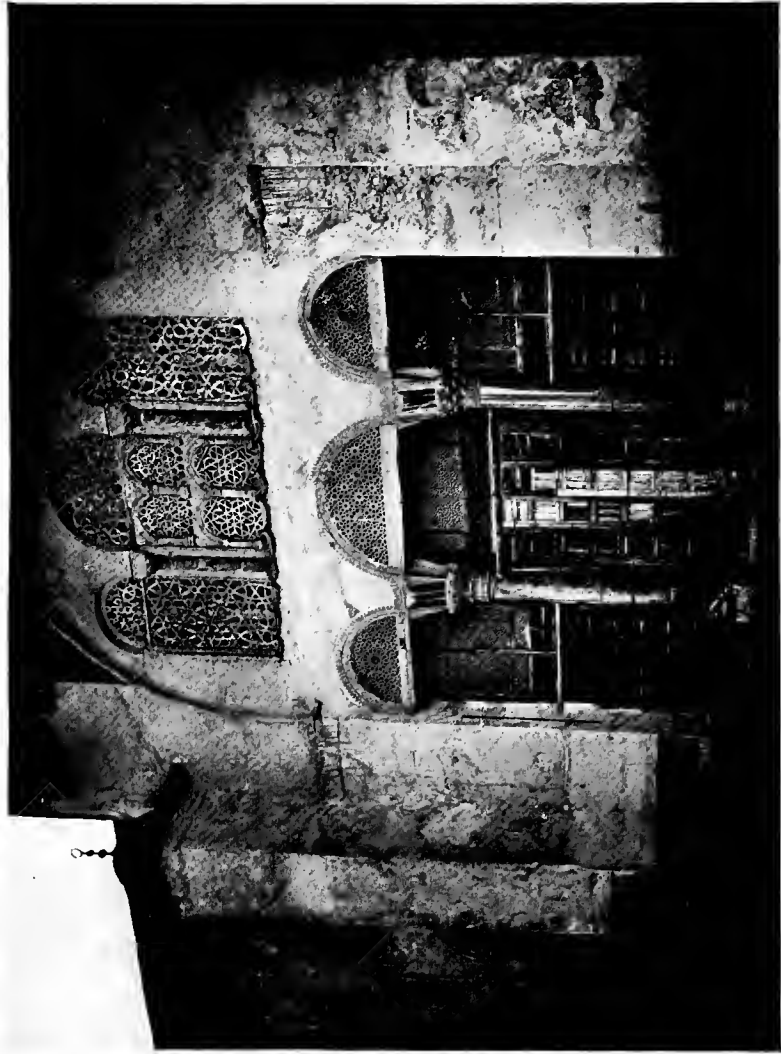

DAMASCUS. CENTRAL PART OF GREAT MOSQUE

CHAPTER III

LATER BYZANTINE, AND ROMANESQUE ORIGINS

IN the West, as we shall show in this chapter, Byzantine influence was widely distributed, and led up to a new epoch of art which may be said to have appeared about the year 1000.

After the campaign of Belisarius and the establishment of the exarchate at Ravenna, Rome was hardly less Byzantine than Ravenna itself. A large Greek colony was settled there, and this was much increased during the iconoclastic persecution after 725, when Sta. Maria in Cosmedin, the Church of the Scuola Greca, was in consequence rebuilt, and a large number of Greek monasteries were erected. Recent excavations at S. Sabas, Sta. Maria Antiqua, and S. Clemente, have brought to light much new evidence in regard to this period, when it seems that the arts in Rome had fallen into the hands of the Greeks. S. Sabas was the church of a Greek monastery. Here the lower part of the apse, work of the sixth or seventh century, was painted with a row of saints having inscriptions both in Greek and Latin. At Sta. Maria Antiqua all the inscriptions were also bilingual, and the paintings are obviously Greek. In the lower church of S. Clemente a large series of paintings was found, probably of the eighth

century, which, although less typically Greek, are evidently an outcome of the Byzantine school.

All the mosaics of this middle period, such as those in the Chapel of the Lateran Baptistery, must be Greek. Cattaneo, speaking of the mosaics of S. Prassede, says: "Like those which were executed in or out of Rome from the sixth to the ninth century, they are, according to my judgment, of Greek workmanship. This opinion agrees with what Leone Ostiensi says, namely, that when Desiderio, Abbot of Monte Cassino, founded in 1066 a kind of school of mosaic-work under the direction of Greek masters, he revived this art in Italy after it had been five hundred years extinct. Lanciani figures the brick stamp of Pope John VII. (705-707), the letters of which are in Greek, ΙΩΑΝΝ. The South of Italy during the eighth, ninth, and tenth centuries became almost entirely Greek. In the North, Venice and Ravenna were equally Byzantine during this period. Rivoira gives a monogram found sculptured on the round tower of S. Apollinare Nuovo, Ravenna, which he would read as that of Bishop Johannes (850-878), but it is clearly in Greek, as shown by the delta and the termination in OV, and Strzygowski reads it ANΔPEOV. (*See Fig. 29.**)

Constantinople forms a broad bridge between Roman antiquity and the Middle Age, and there all artistic traditions were preserved and handed on. Only in Constantinople is it certain that there is continuity

* The dates of the Ravenna towers are undecided; some hold that they are of the sixth, others of the eighth century; the later date is, I think, more probable.

between the Roman *Collegi* and Mediæval Guilds. Other Guilds *may* have survived in the West, but common features between those of Constantinople and those of Italy and France, at a later time, seem to point to direct transmission. Leo the Wise, son of Basil I., under whom the arts greatly revived in Constantinople, made a new codification of the laws, including those relating to merchandise and craftsmanship. From these it appears that the Corporations of Constantinople in the ninth century had for Grand Master the prefect of the town, who was the intermediary between them and the Government; and the edict of Leo relating to these corporations bears the name of "The Book of the Prefect."

The crafts occupied fixed quarters in the city, and all products had to be sold in open market at a standard price; the corporation usually bought materials in block, which it distributed among the members of its College; but in the regulations referring to the Building Crafts—joiners, plasterers, marble-workers, locksmiths, painters, and all "artisans who undertake works"—we find that it was customary for the employer to furnish materials and for the craftsmen to engage to do the work. The corporations are named in the following order: notaries, goldsmiths, exchangers, merchants of silken goods, Syrian merchants, merchants of raw silk, silk spinners, makers of silken goods, linendrapers, perfumers, chandlers, soap-makers, spicers, salters, butchers, pork merchants, fish-mongers, bakers, innkeepers, cattle brokers, and, last, all those who undertake any kind of work as joiners, plasterers, &c. The customs here made known to us are extraordinarily like Western Guild regulations.

Byzantine art in Constantinople speedily declined after the age of Justinian, and the most beautiful buildings of the next epoch are those built for the Mohammedan conquerors of Syria and Egypt by Greek masters. The Dome of the Rock at Jerusalem, and the Aksa Mosque were built by Abd-al-Malik at the end of the seventh century. It has been said that the latter is Justinian's Church of the Virgin altered to a new purpose, but it seems more likely that the church was on an entirely different site—on Mount Sion—and that the fine capitals in the Mosque were wrought for their present position. The Mosque of Damascus, built about 705, was, of all these Byzanto-Arabic works, the most beautiful, having a vast arcaded courtyard which was patterned with mosaics all around above the arches. (Plate 14.) An agreement between the Caliph Walid and the Emperor provided that the latter should supply *fsefysa* (mosaic) to adorn the new mosque which he was building. The exterior of the Dome of the Rock was also covered with similar mosaics. The mosque of Amr at Cairo was rebuilt in 711 in a form which it still preserves, although it has been added to. Arab art is probably largely of Coptic origin.

The history of later Byzantine art following the age of Justinian has never been fully set out. A second marked period is found in the work of the eleventh century, which represents a revival under the Basils, and the beginning of which probably coincided with the restoration of orthodoxy in 843. It has lately been argued that the basilican Church of St. Demetrius in Salonica was rebuilt in the seventh century, but in any case it follows the tradition of sixth-century work. The church now the Kalenders

Mosque at Constantinople, probably belongs to the intermediate period. The similar small cruciform church of Protaton, Mount Athos, is dated c. 950. The later style is more Oriental and not so universal as the earlier work. Elements seem to have been absorbed by it from Persia and Armenia, and some of the later carvings have become semi-barbarous, consisting of beasts tearing one another and of birds of prey—an Eastern savagery parallel to the Lombardic.

The eastern wars and the great iconoclastic dispute broke the tradition of the Hellenesque Byzantine style. When there came a revival in the arts the style is so changed as to call for a distinct name—Secondary Byzantine may serve our purpose, but I believe that Armenian Byzantine would express the facts. Kondakov, who has carefully examined the iconography and ornamental arts of the two periods, says that the later miniatures, mosaics and enamels are deeply affected by Oriental influences. “At the end of the tenth century the Byzantine empire has lost its true Greek national tradition. The government, commerce and industry have been invaded by Oriental and barbarous elements; the throne and the army have become the prey of Armenians and Slavs. In art the sculptured panels of Georgia and the gates of the churches of Armenia decorated with arabesques offer direct correspondences with Byzantine works. The Christian Orient and Constantinople reformed the architecture in the same sense. Hence the picturesque narrow corridors, tall tambours and barbarous ornament.”

The later buildings are for the most part small, the domes are raised high on drums and partake of the

character of central circular towers; the walls are of stone, or their exterior surfaces are much ornamented with patterns formed in the brickwork. Of this class of surface-work the most beautiful example is the palace on the western walls of Constantinople, sometimes called the Palace of Belisarius, but which was probably built by Constantine Porphyrogenitus. One of the most complete Byzantine churches in existence, St. Luke in Phocis, a description of which has been recently published by Messrs. Schultz and Barnsley, well represents the later type of churches; it was built early in the eleventh century.

As types of these late buildings I give small plans of the church of the Monastery of Daphne at Athens (Fig. 33), and of the church on the island of Chios (Fig. 34). Daphne almost exactly resembles the churches of St. Nicodemus at Athens and St. Luke in Phocis; all were built in the first half of the eleventh century. The plan of the Chios church is also practically the same, except that it is without the lateral aisles. The mosaics of this church are dated 1042-56.*

The fine church of the Apostles at Salonica with its high domes and walls built in bricks laid in patterns must be fully as late, and not as Texier dates it of the seventh century.

The Church at Skripou, which also follows the plan-type of Daphne, is of special interest, as we find its vaulting executed with diagonal ribs.

Messrs. Schultz and Barnsley have given a full account of the very perfect mosaic-scheme of St. Luke's, Phocis.

* Another modification of the same type and plan is found in a church near Athens, where the dome rises above an hexagonal space, two points of which touch the north and south walls.

Strzygowski has described those of Chios, and Didron and Brockhaus have given the schemes of the Athos churches. Of these Vatopedi was founded in 972, and the mosaics belong to the first half of the eleventh century. Millet has devoted a volume to the beautiful mosaics of Daphne.

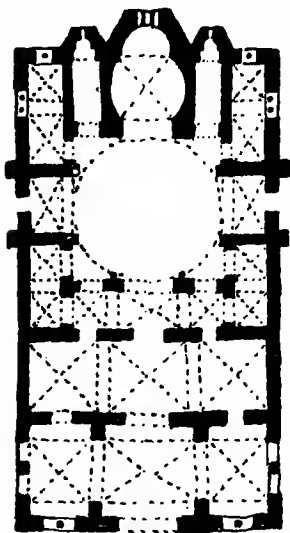

FIG. 33. Plan of the Monastic Church of Daphne, near Athens.

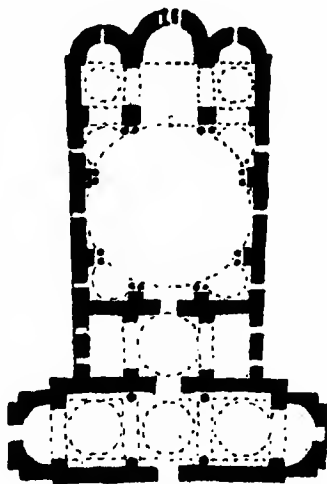

FIG. 34. Plan of the Church on the island of Chios, eleventh century.

The only mosaic-scheme of which we know anything at Santa Sophia, Constantinople, belongs to this later time. At the centre of the dome was a colossal figure of Christ, the Pantokrator; in the pendentives are still four immense cherubim; on the walls to the right and left were depicted prophets, great saints of the Eastern Church,

and probably Apostles; on the conch of the east apse the Virgin with the Holy Child was seated on a throne; on the vault immediately over the altar were the Archangels Michael and Gabriel; and at the crown of the vault between them was the Veronica; on the great eastern arch was figured the Throne prepared for the Second

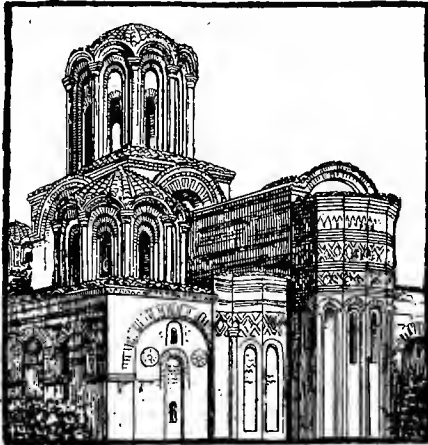

FIG. 35. Church of the Apostles, at Salonica, after Texier.

Coming of Christ, and at the springing of the arch, St. John the Baptist, and the Virgin; the great western arch had at the Crown the Virgin, and figures of Sts. Peter and Paul at the springing; over the entrance door was the Majesty between medallions of the Virgin and a winged figure of St. John the Forerunner, and at Christ's feet an Emperor; in one of the cupolas of the galleries was represented the Pentecost, the twelve Apostles in a circle receiving the tongues of fire from the Holy Spirit

in the midst ; in the west gallery were subjects from the Life of Christ.

One of the finest existing dome-mosaics is that of Santa Sophia, Salonica, which has at the centre Christ seated on a rainbow within a circle borne by two flying angels. Below, round about, are the twelve Apostles, and the Virgin accompanied by two angels, all standing on rocky ground with a tree separating each figure from the next. The mosaics were described in 1849 as "still quite fresh with the exception of a large Virgin and Child slightly disfigured." This subject was in the apse, which I find described a few years later as having a figure on a gold ground, "I should say a Virgin and Child, but thoroughly defaced." Around the Bema Arch was an inscription referring to the building of the Temple of Jerusalem. On the side walls was an inscription giving the names of Constantine and of Irenius, Bishop. Around the dome, another inscription which gave the first figures of a date, the rest being unfortunately destroyed ; this date has been interpreted as having been 490, or again, 645, but must be later.*

This Church is mentioned certainly in a document of 685-695, but I cannot think that the mosaics go back so far as any of these dates. We have seen that the Ascension was figured on the dome of the Apostles Church, when described about 900, but it may then have been just completed. The scheme as found at Salonica exactly coincides with the directions for representing the Ascension, given in the painter's manual, written at a later date, and resembles the central dome of St. Mark's (c. 1100).

* See *Byz. Zeits.* 1895, p. 432.

Compare also an ivory panel, apparently of the tenth century, figured by Schlumberger.* Altogether I cannot think that these mosaics were earlier than the tenth century.†

Several fine floors of 'marble inlaid with meandering bands of mosaic which were executed in the tenth and eleventh centuries, still exist in Greek churches. From this method of "parcel-mosaic" sprang the so-called Cosmati work of Rome. Such work if found there would at once be accepted as Cosmati work of the thirteenth century. (See Plate 15.)

It was this late Byzantine style acting on the West by many channels, by the migration of its artists, by the dissemination of ivories, MSS., bronzes, gold-work, textiles, and enamels, which gave the artistic impetus which led up to Romanesque art. The West, of course, contributed the ability and readiness to absorb and transform these influences.

At the time we are considering a church-plan is found in many places, as at Salonica, on Mount Athos, and in Armenia, which has apses projecting north and south of the central area as well as to the east. (See plan, Fig. 36, of St. Elias, Salonica, c. 1012.) We shall see farther on how this plan became a favourite one in western Romanesque architecture.

* "Un Empereur Byz." p. 453. This, and "l'Épopée Byz." by the same author, contain a large body of illustrations of tenth to twelfth century Byzantine Art.

† Since writing the above, I have seen the tract of E. G. Redin giving photographs of the mosaics and inscription: he assigns them to the eleventh or twelfth century. The Virgin is a very beautiful figure, much like that at Torcello. For the last word on the inscription see J. Kurth in *Athen. Mitth.* xxii. 1897.



RAVELLO. PULPIT OF PARCEL-MOSAIC, USUALLY CALLED
COSMATI WORK

In the tenth century, probably the most original forms in the art of building were in use in Armenia. The remarkable churches of the deserted walled city of Ani are built of finely wrought stone in a style partly Byzantine, partly Persian, and with certain features which are curiously like Romanesque work.

Wall-arcades are largely used, the roofs are steeper than in Greek work, and a tower and cone take the place of the central dome; arches are pointed. A good account of this architecture has lately been given by Mr. Lynch.*

I had written so far before I had seen of the discovery of the extremely important link in the church of St. Gregory the Illuminator at Etschmiadsin, built in 640-661 by the Patriarch Nerses III. This shows that the favourite Armenian plan of

the form of a lobed cross or quatrefoil dates from an early time. The central area of this church was a quatrefoil surrounded by an aisle circular to the outside. Four strong pillars at the points of the quatrefoil once bore a dome. The presbytery occupied the eastern lobe of the cross, and this alone was surrounded by a closed wall; the other lobes were set round by columns, all having basket capitals and monograms of Nerses. The great piers had attached three-

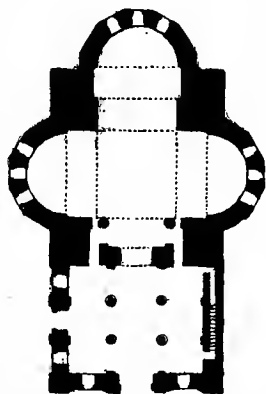

FIG. 36. Plan of the church of St. Elias, Salonica, c. 1012.

* "Armenia: Travels and Studies."

quarter columns, and the aisle wall was decorated by small attached pillars, which evidently formed part of a continuous wall-arcade like that of the apse of Ani. This and the three-quarter columns of the great piers are

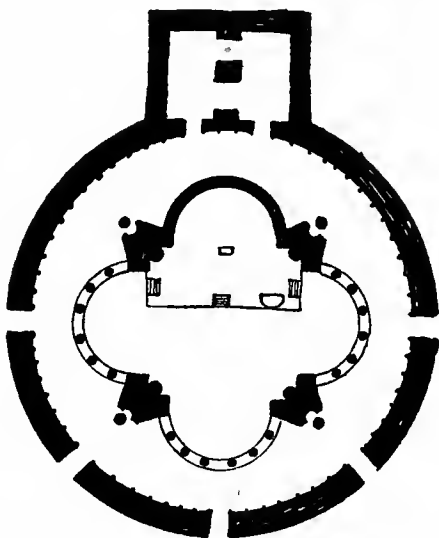

FIG. 37. Plan of the church of St. Gregory, Etschmiadsin, Armenia, c. 650.

strangely "Romanesque" features to find at so early a time. (See Fig. 37.)

The lobed cross plan is again repeated in a more marked form in the probably equally ancient plan of the patriarchal church of Etschmiadsin. Here the four great piers stand within a square area from which, in the centre of each wall, opens an apse—four in all. (See Fig. 38.)

One of the most remarkable of the churches noticed by Mr. Lynch is that of Akhtamar, described as unique in his experience. It is built of squared reddish sandstone, on the apsed cruciform plan, 48.6×38 feet inside, with a sixteen-sided tower over the crossing, capped with a stone

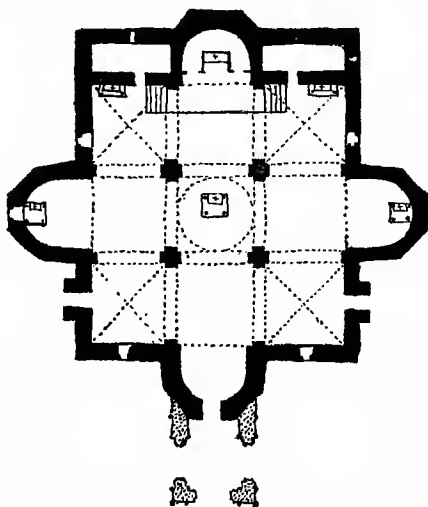

FIG. 38. Plan of the Cathedral of Etschmiadsin, Armenia.

cone, or rather many-sided pyramid. It is "a work of the first quarter of the tenth century." The exterior walls at the half height are adorned with a series of relief sculptures of Bible stories and other subjects—the Serpent tempting Eve, Adam and Eve on either side of the tree, and in one place a king presenting a model of the church to an ecclesiastic. The roofs, and this is general in these Armenian churches, are covered with stone slabs, evidently

bedded solid on the vaults, the inclined joints being covered with half-rolls of stone. The walls are built in very finely jointed ashlar of big stones.

I have seen photographs of Eslick Vank church, Tor-toom, which clearly belongs to the same school. It is said to have been built by Gugol in the reign of

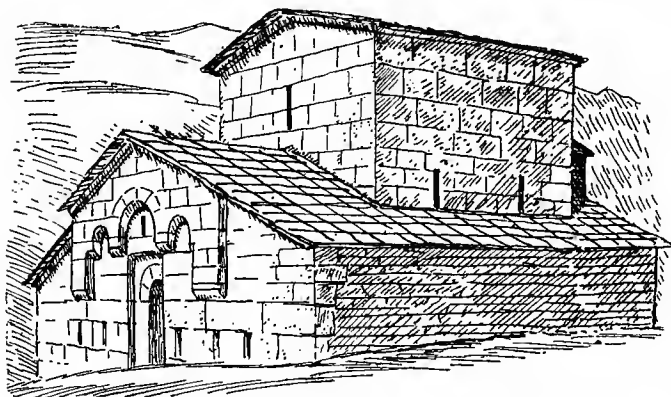

FIG. 39. Church of Ushkal, Souanetie, in the Caucasus.

Ardaneses II. of Georgia between 923 and 927. It is a fine stone-built cruciform structure, with a central tile-covered cone over a high drum. The exterior has a good deal of sculpture, and in the interior is a large sculptured group, of Christ in the centre with hand upraised in blessing, on the left the Virgin, on the right St. John, and, beyond, two other figures with *square* nimbuses, a king and ecclesiastic, each carrying a similar model of the church.

I have also seen photographs of the noble Convent

Church of Gelati, near Kutais in the Caucasus. This is built on a cross plan with one great apse to the east and two smaller ones on each side of it opposite the ends of the aisles; the aisles extend to the face of the transept;

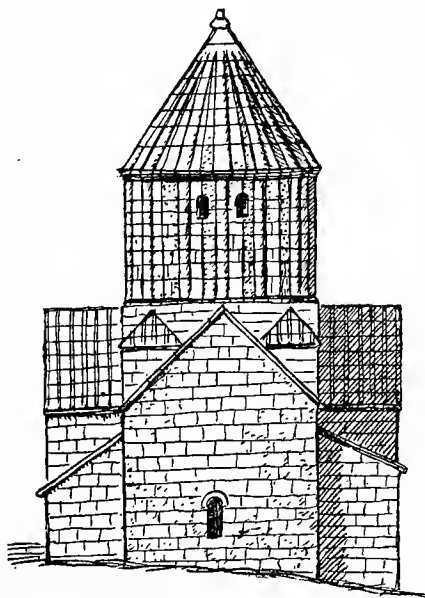

FIG. 40. Church at Anabat, Van, in Armenia.

at the centre is a tall circular tower with conical roof. Brosset gives a useful plan of this fine church, but the beauty of these monuments cannot be imagined from his poor diagrams. I give a slight sketch (Fig. 39) from a photograph of a small church in the Caucasus, which would not at all surprise us if found in the West. Fig. 40

shows the high cones and stone roofs characteristic of many of these Armenian churches.

Another beautifully built stone church is the ruined cathedral of Koutais, the finest of Georgian monuments, built *c.* 1003; the façade has tall recessed pointed arches.

Ani Cathedral, built about 1010, is especially remarkable in having the dome upborne on *pointed* arches built in several recessed orders rising from piers also membered. The exterior is surrounded by a single storey of wall arches, while the apse within has a deeply recessed wall arcade of small scale, exactly like such arcades in the west. This in Texier's plan, in Mr. Lynch's photograph, and Brosset's diagram of the interior, seems strangely western. Compare also an interior given in Strzygowski's *Klein Asien*. Other of these Ani buildings are built in a Persian style; one called by Mr. Lynch the Church of the Apostles has a large porch with domes supported on *diagonal* arches. These Armenian churches are built of very fine squared masonry, the character of which seems to be derived from the Syrian school of building. The greater part of Armenian architecture is probably an outcome of an admixture of Hellenesque and Persian influences. In the Persian Palace of Ctesiphon and in the remarkable building at Rabbath-Ammon are found wall arcades decoratively applied just as in the Armenian churches. The second-named building indeed must, I should think, have been built by an Armenian master.

When we compare with the Armenian churches a late stone-built church in the West, the little cathedral of Athens with its dome on a high drum at the intersection of four roofs, and its profusion of semi-barbaric carvings,

it is impossible not to recognise that the church is almost Armenian.

The step to the brick churches is easily made, and it seems likely that the apsidal-transept plans were derived from the typical Armenian plan. Strzygowski has pointed out that the new influence probably made room for itself under Leo the Armenian, 813-20. Of six churches on Mount Athos, the plans of which were noted by Dr. Covell about 1670, four, including the Catholicon of Vatopedi, had three equal apses pointing East, North, and South. He describes the church of Vatopedi as having a cupola standing on four pillars of ophite and as having been once all covered with mosaic, "there is yet in the inner Narthex the Annunciation admirably done." Before the entrance to this Narthex hung a rich embroidered ante-port given by Andronicus-Palaeologus, and showing his monograms. "The outward gates are of brass, and have the Salutation engraved on them."* Fig. 41 is a diagram from Covell's sketch of this church, which was built from 972. A second church of the same form on Mount Athos is that of Iviron, founded by George the

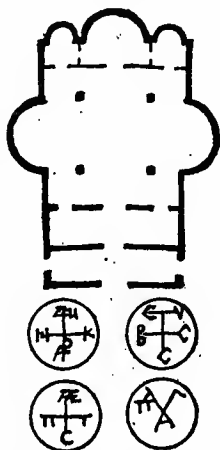

FIG. 41. Diagram plan of the church of Vatopedi, Mount Athos, with monograms of Andronicus.

* British Museum MS. Covell also saw the largest church on Patmos, which he says was built by Alexius Comnenus, as was shown by an inscription. For Mt. Athos see Brockhaus and Kondakov.

80 BYZANTINE AND ROMANESQUE

Iberian about 976. This George, who was the true founder of the Athos communities and began the Laura in 963, may have brought this plan directly from Armenia, or it may have come by way of Constantinople.

As the Byzantine style in its own proper habitat changed in response to ideas derived from Armenia and the East, so there is reason to think that the art of the West generally, by absorbing fresh stimulus from Eastern sources, gradually changed its complexion from the conservative art which looked to Rome to the progressive art which developed through Romanesque to Gothic. These developments were derived directly from the East—above all through the ports of the Mediterranean, the sea which through historic time has distributed culture. The chief points which concern us are the origin of vaulted and cruciform churches having central towers: that is, the typical Romanesque church. There are indeed many indications that tall and slight wall arcades like those of the ground storey of Pisa Cathedral; towers roofed in gabled sections like some German examples; and even perhaps the typical Norman notched and zig-zag ornaments, are all derived from oriental sources.

The term Romanesque has been generally accepted for the art which, in many forms in Italy and the West, fills up the space between the decline of the first Christian art and the emergence of Gothic. The earlier forms of these schools might better be described as Byzantesque, or Proto-Romanesque. More specifically Romanesque must be understood to mean a Northern school of art characterised by movement rather than by adherence to tradition, and tending towards the development of Gothic. In its

highest state it is represented by large cruciform churches having a cupola or tower over the crossing, with a circular apse and radiating chapels; such a church was completely vaulted, and at last these vaults were supported by ribs. Dr. Strzygowski, in a series of books, has recently been studying the continuous action of Eastern art upon the West. He does not think that this influence was so much passed on through Rome as by way of Ravenna, Milan, and Marseilles. He finds the origin of Romanesque architecture in Asia Minor, Armenia and Syria, where at an early time churches are found which have many of the characteristics of Western work of the eleventh and twelfth centuries. He classes these Eastern churches into (1) Basilicas; (2) Octagons; (3) Domed Basilicas; (4) Domed Cross-churches. He shows that some of the first were, in the East, entirely covered with stone vaults.

At Binbirkilisse, in Asia Minor, there is a large early basilica, the central vault of which was supported by chamfered transverse ribs. Another church has the aisles covered by a series of ramping transverse barrel vaults inclined upwards to the nave arcade. Gayet gives the plans of more than one Coptic church with barrel vaulted naves. More than half a century ago Lepsius described and gave the plan of a church which he found far up the Nile at Barkal by Dongola, which from the plan seems to have been entirely vaulted, and possibly to have had a cupola over the centre. (*See Fig. 42.*) He describes it as built as high as the windows of well-hewn sandstone, and above that of unburnt bricks covered with plaster. The whole was surrounded by a great court containing numerous convent cells. See also the plan of the North

African basilica of Kef, Fig. 43, as restored by C. Diehl. The church of S. Focà, Priolo, Syracuse, again was an entirely vaulted basilica of early date (see *Byz. Zeit.* 1899). Such vaulted basilicas seem to have been common in the

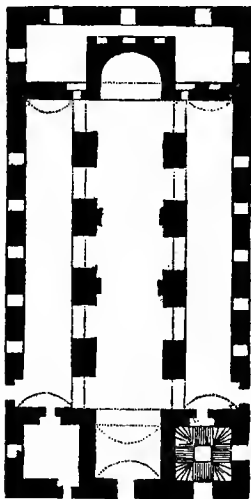

FIG. 42. Christian Basilica, from Barkal near Dongola, Egypt, probably entirely vaulted, of sixth century (?)

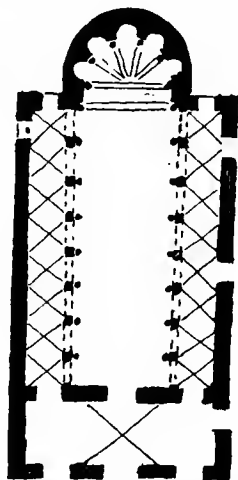

FIG. 43. Christian Basilica of sixth century at Kef, North Africa, partly vaulted, from Diehl's "Justinian."

East. St. Irene, Constantinople, is a modification. The tenth-century (?) writer known as the "Anonymous," describing S. Sophia, says it was at first of basilican form, and that Theodosius covered it with cylindrical vaults. This at least shows that the idea was familiar to those in Constantinople.

The octagonal and circular churches, where a central dome borne on pillars was surrounded by a vaulted aisle, easily passed into the cross type by accentuating the four cardinal sides, as was the case at Nyssa in the fourth century.

The domed basilica is a very interesting approximation to the cross-church, but in it the arcades are continued across what would be the transepts in a fully developed cross-church. If Rohault de Fleury's restoration is to be trusted, the fifth- or sixth-century church at Spoleto approximates to this class. Of domed cross-churches Strzygowski gives, as an instance, the ruins of a fine church at Philippi, more fully described in the *Byzantinische Zeitschrift* for 1902.

I give a plan of a small cross-church or baptistery at Doclea in Montenegro, probably of the sixth century. The plan of a very striking church, St. Titus, Gortyna, Crete, which has been shown to me by Mr. Fyfe, is markedly cruciform, the arms being terminated by apses opening N. and S., the great apse being of the transverse triple arrangement shown in Fig. 6.

Much has been said as to a late development of cruciform churches, but I cannot find any arguments which show more than the fact that the exact late conditions are only found at a late time. Mr. Micklethwaite, in his most able tract tracing the development of the plan of the Saxon church, seems to make the cross-type come about as the result of a series of accidental approxi-

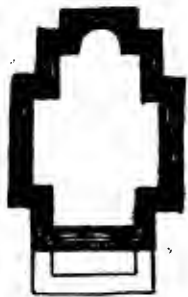

FIG. 44. Plan of church at Doclea Montenegro, c. sixth century.

mations made wholly in England; and Prof. Baldwin Brown, following the same lead, writes that the "early Greek cross-plan is not in the direct line of development which ultimately produced the Latin cross-plan of later mediæval days. . . . The early Greek cross-plans involved the feature of a central pavilion. . . . This is not the same thing as the later central tower over the intersection of the arms of a Latin cross." *

I think that a truer view of the case would be arrived at in some such general statement as this:—There have been in the main two great and persistent types of church plan, and the final type of large Western churches was reached by combining the two. The first is the Congregational, basilican, or *ship* type of plan, with its long columned aisles; the second is the martyrion, circular, or *cross* type, usually entirely vaulted. Both were in use from the age of Constantine, but in certain parts of the East, as in Asia Minor, North Syria, and Armenia, the latter type was particularly favoured, and ultimately almost prevailed over the basilican type. In the seventh, eighth, and ninth centuries, churches of the eastern cross-type were frequently built in the West, and finally the *aisled* cross church of Romanesque type was reached by bringing the two types together. An interesting sidelight on this transformation is given by the adoption and development in the West of the plan in which the transepts have apses opening north and south like Fig. 36. The Western, vaulted, Romanesque church, with its central lantern tower, is a translation of the Eastern central-cupola type into the terms of the basilican church.

* "Art in Early England," vol. ii. p. 285.

We surely might have been safely certain that from the time when the cross-symbol was well developed churches of that form would be specially delighted in, and of this there is overwhelming proof. St. Gregory of Nyssa, in the latter half of the fourth century, describing his proposed church, says: The ground plan is a cross; that is, it is composed of four spaces which are connected, as one generally finds in the cross-shaped plan, by a circle set into the cross.

I have called the figure a circle because it runs round like a ring, but its form is given by eight angles. Four sides of the octagon which lie diametrically opposite to one another connect the middle space through arches with the four contiguous spaces. The other four sides of the octagon do not open in the same way into like spaces, but a half circle embraces each of them, which at the top rests on the arch in a shell-like rounding. Thus there are eight arches in all, by means of which the squares and half circles which lie opposite to one another respectively, are put into connection with the middle space. Within the square-shaped spaces which lie opposite one another are to be placed the same number of columns [as in the octagon]; they also will carry arches, and are indeed of the

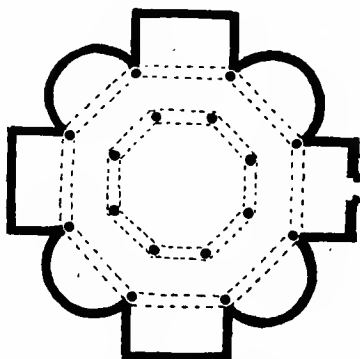

FIG. 45. Church at Nyssa, fourth century, from S. Gregory's description.

same construction as those of the middle centre-space. Over these last eight arches (of the octagon) the eight-cornered space will be raised four ells higher to receive the windows placed above them ; above this is a conical roof. The breadth of each of the four-cornered spaces will be eight ells, while the length should be half as much. So also the half-circular niches show eight ells. The walls are three feet thick outside these measures. The structure is to be vaulted and of brick and stone ; the columns channelled and with capitals of the Corinthian style ; the door jambs marble, with a frieze of reliefs above.

I have condensed this interesting account, the earliest precise description of a Christian church, from Dr. Strzygowski's rendering,* and give a diagram which should be compared with the slightly different figure in his *Klein Asien*.

At about this same time St. Ambrose erected at Milan the Church of the Apostles *ad modum crucis*. Later, Procopius tells us how the Church of the Apostles in Constantinople was set out in cross-form. And Arculph has left the plan of the church at Jacob's Well, a perfect cross. Of the Abbey Church of Ramsay in England, built 968-974, it is said that it was built after the pattern of a cross with a tower in the midst sustained by arches over the projecting arms. At the west end was a smaller tower.

It may here be remarked that the early symbolic use of the cross-form is found very frequently in fonts, in Constantinople, in the Greek Islands, in Armenia, and in Palestine. As an example of a large church of the

* *Der Dom zu Aachen. Ein Protest.*

cross-type, the Church of the Nativity at Bethlehem may be cited, and that it was recognised as such is proved by the fact that it is described by the traveller Willibald in the eighth century as "a glorious building in the form of a cross."

In Sicily there are the ruins of several small cross-churches, which are plainly Byzantine work. One of the most perfect is S. Croce Camerina, Bagno di Mare, of which the stone-built central dome is still standing.

(Fig. 47, A.) At Roccella di Squillace in Calabria is a most remarkable large ruined cross-church, which has the appearance of being a fully developed Romanesque work, especially in its plan. It has been assigned to the sixth or seventh century, and comparison with other brick churches in Asia Minor given by Strzygowski makes

this less difficult to believe. On the other hand, it has some resemblances to Murano, built about 1000, and is much what we might expect to find in a Norman church built by Calabrian Greeks.

Caviglia takes the view that it was built as early as 550-600, and says it was suppressed in 1113. Bertaux, however, in his fine *L'Italie Meridionale*, 1904, points out its resemblance to Monreale, and considers it to be of the twelfth century—a view with which I must express agreement. This church was about 220 feet long, built of thin bricks and the choir vaulted, the roof above being a terrace homogeneous with the vault. (See Fig. 47, B.)



FIG. 46. Cruciform Font from Palestine.

R. de Fleury gives the plan of the foundations of the Church of St. Andrew at Rimini, which was of the sixth or seventh century, and cruciform. (Fig. 48.)

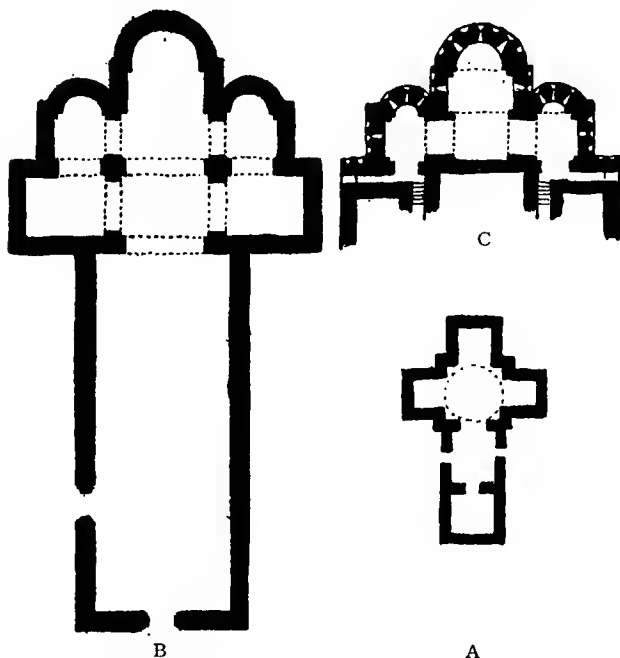

FIG. 47. A, Plan of S. Croce Camerina; B, S. Maria di Squillace; C, Its Crypt.

Strzygowski sums up the characteristics of the Syrian and Asia Minor schools as being—the use of vaulting instead of wood roofs, the absence of an atrium, a west façade having a porch between two towers, the use of piers as supports instead of columns, the addition of a

square compartment before the apse, and the bringing of windows together in groups of two or three. He suggests that these details, as well as the general type of the church, went to form Western Romanesque. He also shows that the churches having an apse at the west end as well as at the east are first found in Egypt and Syria,* and he suggests that even the radiating chapels of Romanesque churches were ultimately derived from the niches round about the apse in Egyptian convent churches, St. Martin's at Tours, built 472, being the link.

It is certain then that in the East basilican churches were vaulted from an early time; and that churches were also as a continuous tradition planned in the form of the Cross. In these buildings piers frequently take the place of columns, and these piers were in Armenia recessed into a series of orders. Here also a central tower takes the place of a low dome. In these facts we may find the origins of Romanesque Architecture. From the seventh to the ninth centuries there were built in the West a series of "Central Churches" which have the closest resemblance to

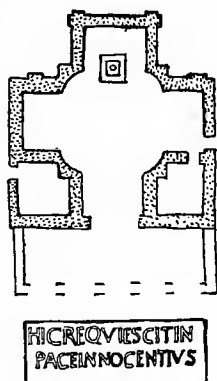

FIG. 48. Plan of destroyed church of St. Andrea, Rimini.

* The Cathedral of Canterbury as first made known to us by description was of this double-ended type. It has been assumed that the W. apse of this church was built by Augustine, but this is not *certain*. The Carolingian church of St. Gall was planned in this form from the *first*. There was a second double-ended church in England at Abingdon, both may have followed the Carolingian type.

Eastern martyrion churches. Already at the end of the seventh century Wilfrid of York began at Hexham a church in the form of a round tower with four arms. In Milan, St. Satyrus, 879, and near Orleans, St. Germigny des Prés, c. 800, nearly repeat the Armenian plan of Fig. 38. Charlemagne's church at Aachen falls into the same class, and our King Alfred at Athelney built a church in the form of a cross with ends rounded in a quatrefoil. We may easily find a reason for the form of Wilfrid's church in the presence in England of the great Archbishop of Canterbury, Theodore of Tarsus, 669-690, but another cause besides the general influence of the East on the West for this form of church appearing in the West is to be found in the fact that Syrians and Armenians were pre-eminent as stonemasons.

In the transition to Romanesque in the West, account will have to be taken of the place of North Africa in archæological geography and of the probability that a stream of influence flowing from Alexandria by way of Carthage to the shores of Spain tempered the conditions in the West by a sort of Gulf-Stream of art. In the many churches of North Africa recently explored by Gsell and others, many of the details resemble Romanesque work, and at least five churches have been found of the counter-apsed form followed at St. Gall.



From a photo by Mr. H. Ricardo

BORGO SAN DONNINO (See p. 114)

CHAPTER IV

ROMANESQUE ART IN ITALY

WHEREVER in Italy we see a school of architecture in course of formation, we shall find that it has its roots in a fresh Byzantine impulse.

It has long been thought that the origins of Italian Romanesque are to be found in a supposed Lombardic school; but more recent examination has shown that the Lombardic monuments are themselves of comparatively late date.

When the long strife of Goths, Latins, and the armies of the Eastern Empire, had exhausted Italy, the Lombards conquered the Northern Provinces about 568, set up their capital at Pavia, and became the chief power in the land. The Exarchate, Rome, and the far South, however, remained outside of their direct sphere of influence. The Lombards were one of the Germanic peoples who, about this time, formed new nations within the confines of the Western Empire. They acknowledged relationship with the Saxons, Franks, Lotharingians, Bavarians, Suabians and Burgundians. When, later, Charlemagne subjected them to his empire, it involved only a change of dynasty, not of people. The significant facts in art during this era are—

the continuation of the early school in Rome, modified by influences reaching it from the Eastern capital; the waning of early Byzantine art in the city of the exarch; and the slowly permeating element of barbarism which resulted from the Germanic conquest.

The Lombards must at first have taken over the traditions of the land, and there is no evidence for anything like a distinct form of art in Lombardy until after the direct rule of the Lombard kings had passed away. Lombardic art is rather to be understood as a geographical than a dynastic distinction; and some of the most characteristic works of "Lombard" architecture were built as late as the twelfth century.

The general style from the sixth to the eleventh centuries Cattaneo has called Italo-Byzantine, and he has rightly denied the existence of any specific Lombard school during this time, except so far as it shows itself in barbarism. He has also pointed out that the first active and indigenous school to arise had its centre at Venice. It was, indeed, in origin strictly Byzantine, but in Venice it found such a congenial soil that it soon took root, and bore even finer fruit than at the same time in its original home.

Cattaneo, who knew every sculptured stone in Venice, and had the most penetrating insight for their classification, sorted out several as having belonged to St. Mark's Church as rebuilt in 976, and in these are to be seen the clear evidences of the new growth. In Torcello Cathedral, rebuilt in 1008, we have the most perfect and assured example of this Venetian Byzantine style. The marble capitals of the nave are magnificent. Ruskin, who at least

was a supreme judge of beauty, says that they are amongst the best he had ever seen as examples of perfectly calculated effect from every touch of the chisel on the snowy marble. Torcello is altogether a noble church. In the apse is one of the most striking mosaics in existence, being a single figure of the Virgin, habited in blue, on a gold field; while at the west end, in opposition to her stately calm, is displayed the tragedy of the Last Judgment.

It will be interesting to condense the description Beckford gave of it as it was in 1780:—Beyond the altar appears a semi-circular niche with seats like the gradines of a miniature amphitheatre. Above rise the forms of the Apostles in red, blue, green, and black mosaic, and in the midst is a marble chair. The font which stands by the entrance has figures of horned imps clinging around its sides. The windows are closed with shutters of marble.

The existing Church of St. Mark was begun about 1045, and consecrated in 1094, but there are preserved within it many fragments from an earlier church, beside the great collection of Byzantine marbles brought from all parts of the East. There is evidence that the early church was a small basilica, but it was rebuilt as a Greek cross. This is set out with a three-aisled body crossed by a three-aisled transept. The three piers about each angle of the crossing are large and square, forming together great masses which support the domes, while the other bays in the nave and transepts have ancient marble columns. The four arms, as well as the crossing, are covered by domes. Eastward the two aisles and the central span are terminated by apses. The walls of these apses are about ten feet thick, and large niches are cut, as it were, from the

mass—three in the middle apse and five in each lateral one.

Justinian's celebrated Church of the Holy Apostles at Constantinople was, as we have seen, built in the form of a cross and had five domes. It is generally acknowledged

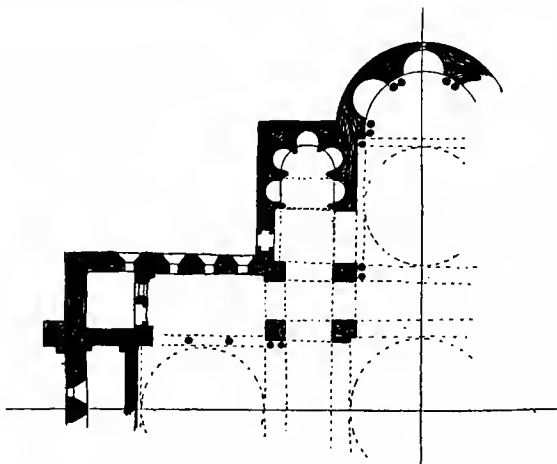

FIG. 49. Part plan of St. Mark's, Venice, showing apses.

that St. Mark's follows the scheme of this church. It may be that even the nipped apse was present in the prototype, for some early churches in Egypt and North Africa have this characteristic. Butler, describing the Church of St. John at Antinoë, attributed by legend to St. Helena, says that churches so ascribed "are always marked by a particular form of *haikal* (bema); witness the Red and White Monasteries, the church at Arment, and many others; . . . a deep apsidal *haikal*,

with recesses all around it, and columns close against the wall." A basilica at Kef, North Africa, supposed to be of the sixth century, has a similar apse, the dome of which follows the scalloped form of the plan. Certain northern apses of the twelfth century, such as Terouanne and Dommartin, probably derive from St. Mark's. At St. Mark's there have been many additions to the eleventh-century church; the western narthex and the high leaved cupolas rising above the dome are amongst them. This church is a treasury of antique columns of porphyry, fine marble, and alabaster, as well as capitals and sculptured slabs, collected wherever they could be found, and dedicated to it as jewels to a shrine. Many of the capitals are from the time of Justinian; some of them are signed with his monogram, and others have *Basileus*, in monogram. These marbles, and the incrustation of the whole interior with mosaic figures and subjects on a golden ground, are its special glories. The subjects of the mosaics on the three domes of the central axis are, to the East the Pantocrator surrounded by Prophets; in the centre the Ascension; and to the West the Descent of the Holy Spirit. The mosaics were begun about 1100. The effect is well described by James Howell (1651)—"The inner part from the middle to the highest part thereof glistereth with gold, and the concavity of the vaults is enriched with divers goodly and

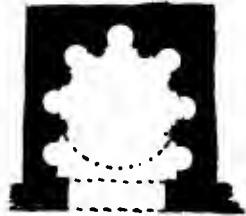

FIG. 50. Haikal of the church at Antinoë in Egypt.

ancient pictures which do present unto the spectator by their grave and venerable aspect, a kind of awe intermingled with piety and religion ; that which is from the gilding down to the pavement is well compassed and joined together with goodly tables of marble. The pavement is marble engraven with divers figures. In sum, there is no place in the whole church but is either decked with

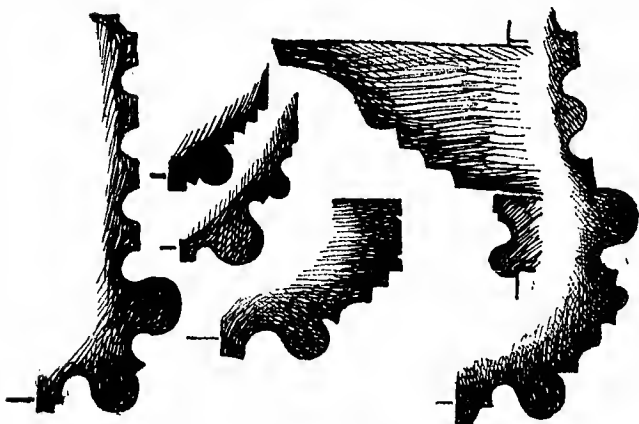

FIG. 51. Sections of marble moulding, from St. Mark's, Venice.

marble, gold, or precious stones." Fig. 51 shows the type of mouldings—door jambs, and a cornice—found in late Byzantine churches in which it is easy to see the germs of Romanesque and even Gothic mouldings. These are from St. Mark's.

Before leaving the Venetian School, Murano must just be mentioned. The church here was begun in 998, and the fine mosaic pavement is dated 1140. The plan is generally basilican, but it has a transept. Its chief features have been beautifully illustrated in the "Stones

of Venice"; but it has now been greatly ruined by restoration. Compare the well-known triangular decoration of the east end of this church with the cornice of Fig. 35. It is still more like work at S.M. Pamma-Karistos in Constantinople. Murano, Torcello and St. Mark's are Greek churches on Italian soil. A legend as to the Byzantine architects of St. Mark's has been printed by E. Muntz.

The next schools to take on a distinctive character were those of Florence and Pisa. San Miniato was founded in 1013, and is almost certainly the most advanced church of its date in Italy. It is commonly said that there was a great outburst of energy in architecture after the dreaded year 1000 was overpast, and this seems to be borne out by the facts. A careful catalogue of the dates at which the churches in the cathedral quarter of Florence were founded, or are first heard of, shows that one—San Lorenzo—was founded by St. Ambrose in 393; one—San Giovanni (the Baptistery), *c.* 670 (?); one—Santa Reparata, 724 (?); in the ninth century there were two; in the tenth, eight; in the eleventh, seventeen; in the twelfth, fourteen; in the thirteenth, six. Moreover, in the eleventh century Florence was re-walled.

Fiesole Cathedral represents in some degree the primitive Tuscan Romanesque. It was begun in 1028, and largely restored in 1206, while the campanile was built in 1213 by Master Michele. It is a small stone-built basilica, with a raised tribune over a crypt. In comparison, San Miniato seems to mark a new departure. It is a basilica of nine bays, but every third bay is marked by a pier formed of four semi-shafts, making a quatrefoil on plan. One semi-shaft of each pier rises higher on the wall than

the rest, and together with the corresponding one opposite supports an arch which spans the nave. In line with these, other smaller arches cross the aisles. The spaces between the arches are covered with an open king-post roof, the timbers being painted with bright colours in patterns. The choir is raised high above a crypt, and the apse opens under an arch similar to the others. The walls and faces

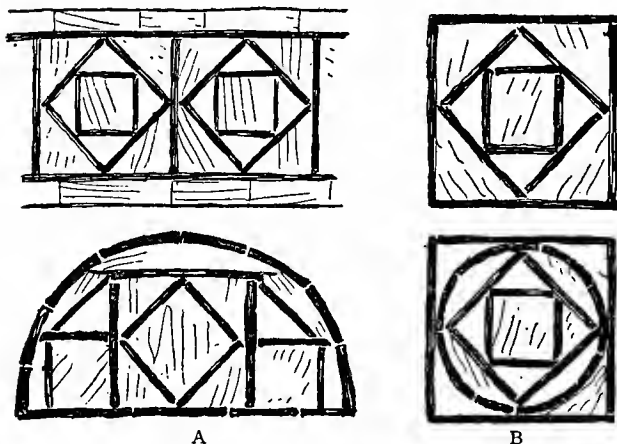

FIG. 52. A, Marble patterns from wall linings in the interior of San Miniato, Florence; and B, St. Demetrius, Salonica.

of the arches are cased in marble, black lines forming simple patterns on a white ground. The western front is also encrusted with marble, it is later than the rest. The windows at the east end are filled with thin translucent sheets of marble. It is a noble church, almost entirely free from the barbaric element in Lombard buildings. The marble windows and linings show the Byzantine influence. (Plate 17.)



FLORENCE. SAN MINIATO, WEST FRONT IN 1875

San Giovanni, the celebrated baptistery of Florence is called by Villani and other early writers the Duomo, but from its close association with the church of Santa Reparata, which occupied the site of the present cathedral, it would appear that it was always more strictly the cathedral baptistery. San Giovanni and Santa Reparata are, after San Lorenzo, the oldest foundations in the city, but their exact date is uncertain, and they may have been contemporary. Santa Reparata had its west front some twenty-five or thirty feet nearer to the baptistery than that of the present cathedral. It was a basilican church with a detached campanile. "Santa Reparata took its title of 'Pieve' through its union with the basilica of San Giovanni, and not from having contained the baptismal font. The bishops used Santa Reparata for the most solemn functions, and it and San Giovanni were considered as one sole cathedral. As says Borghini, 'In Santa Reparata was placed a distinctive seat for the bishop, built of marble, stable and firm.'"*

It is to be observed that the baptistery stands exactly opposite the west door of the cathedral, its own door being to the east and its altar to the west. We find a similar disposition at Pisa, and earlier still at Parenzo, where the baptistery, like the church, is entered from the atrium, but on the opposite side of the court. The space between Santa Reparata and San Giovanni was doubtless at first an enclosed atrium; it was a burial-place up to the thirteenth century.

According to the legend given by Villani, the Baptistery

* A. Cocchi, "Le Chiese di Firenze," 1903. On S. Giovanni, see A. Nardini, 1902.

had been a Temple of Mars. Roman fragments which have been found re-used in its construction may account for this story. San Giovanni is authentically mentioned in a document of 897. Writers have held that originally it had only one door where is now the apse, and that the altar was where the principal door now is. But with all probability there were always three doors, and from 1177 the two porphyry columns, the gift of the Pisans, have stood at the east door. Excavations made in 1895 discovered the old semi-circular apse, which, "without doubt, was the original, supplanted by the present one."* (Pl. 18.)

The mosaics of the tribune were the work of Fra Jacopo in 1225. This friar was one of the twelve original followers of St. Francis. The great mosaic of the octagonal vault, a colossal figure of Christ, twenty-five feet high, was wrought by Andrea Tafi and his master Apollonio. In the apse was a throne for the bishop, and the altar under a tabernacle adorned with sculptures by Andrea Pisano. In 1329 Piero di Jacopò was ordered to go to Pisa "to see the bronze doors which are in the said city," and to draw them, and to go on to Venice to search out a master to work new bronze doors for the baptistery. It seems that Piero did not succeed, for in 1330 the doors were allotted to Master Andrea di Ser Ugolino da Pisa, who employed Piero and others, and had the wax models completed in two and a half months. They were cast in Venice in 1332, but buckled, and had to be straightened by Andrea. This interesting account goes to show that before this time Venice was the chief centre for such bronzework. As to the date of the baptistery in its existing form it is

* Cocchi.



Alinari

FLORENCE. THE BAPTISTERY

FLORENCE. THE I
FLORENCE. THE I

Face p. 100

most reasonable to conclude that the long series of decorative works, ending with Andrea's bronze doors, were the finishings of a rebuilding undertaken not very long before we first hear of works there. As soon as these were completed Santa Reparata was itself rebuilt as the Cathedral of Santa Maria del Fiore, and "Giotto's Tower" superseded the old campanile. If the Baptistery was the first work undertaken in a scheme for rebuilding the whole cathedral group this would account for its reputation surpassing that of the old cathedral proper. Its earlier decorations are in many respects similar to those of San Miniato, and, as a baptistery, it falls into companionship with those at Pisa and Parma. At Pisa we find granite columns like those at San Giovanni. Altogether it is probable that it was rebuilt in the eleventh century.

This Florence Baptistery is one of the most individual and perfect buildings in the world—a great octagonal chamber about ninety feet across, with a domical vault. The external roof is homogeneous with the vault, and it and the walls are entirely sheeted with plates of marble. The wall-mass is lessened in the interior by large recesses on the ground-floor and by galleries above. At the springing of the vault the stone roof slopes against it like a continuous buttress. The floor is covered by a pavement of white, dark green, and sombre red marbles, arranged in small pieces, to form chevroned and rippling patterns which suggest running water, and were doubtless an allusion to the four rivers of Paradise, which are mentioned in the service for blessing the baptismal waters. In one place is a large square inlaid with the signs of the zodiac and patternwork. (Plate 19.)

Villani, speaking of this, says: "We find from ancient records that the figure of the sun made in mosaic, which says, 'ENGIRO TORTE SOL CICLOS ET ROTOR IGNE,' was done by astronomy, and, when the sun enters into the sign of Cancer, at mid-day it shines on that place through the opening above, where is the turret." This palindrome inscription can still be read surrounding the sun figured in the centre; but if the sun ever shone on it in the way Villani says its position would have been quite different, and there is not the least evidence that it has ever been moved.

It stands in the most important part of the floor on the axis directly east of the font. It should be observed that this ornamental square of pavement figures accurately a rose window. Such a window is hardly to be found before the second half of the twelfth century. Even the filling recalls stained glass, and it seems to me that the panel is a translation of the pattern of a French window into Florentine marble. The inscription is in a fine late twelfth-century style, and we may safely conclude that the whole pavement, and the marble wall-linings, are not earlier than the year 1200. The inscription states that Florence, prompt in all good works, had the wonderful pavement made *per signa polorum*, which must be the record of which Villani speaks, but it refers, in fact, to the signs of the Zodiac upon it. The iconographical scheme of the vaults is distinctly Greek, and Byzantine influence is well marked in the drawing of the mosaic figures.

The marble casing and inlaid patternwork are the chief characteristics of this early Florentine style, and these are evidently derived from Byzantine work. With



Alinari

FLORENCE. BAPTISTERY. INLAID MARBLE PAVEMENT

Face p. 102

the inlaid patterns are often found simple figures like the seven candlesticks, and, in the Baptistry, water-pots.

Of external marble work, the Badia below Fiesole is the richest example. The façades of San Jacopo sopr' Arno, of the Bishop's chapel by the Baptistry, of San Stefano al Ponte, and of Santi Apostoli, are all very interesting.

Close to Pisa is the remarkable church of San Piero a Grado, which is as early as, or earlier than, San Miniato, with which it has some affinities of style. Here, however, the striking feature is a magnificent series of very Byzantine paintings, which cover the whole of the walls above the arcades. The church has three apses at one end and a single apse at the other. Most writers see in one end of the church the remains of a Carlovingian building, but the most recent writer on the Pisan churches, Benvenuto Supino,* thinks that the ancient church was rebuilt in sections all "after the 1000."

In Pisa, in 1063, was founded what is, perhaps, the first of the great mediæval cathedrals. It is a five-aisled basilica, crossed by a three-aisled transept. Apses open from the ends of the transepts as well as to the east. Over the crossing rises a dome which, owing to the unequal spans of the nave and transepts, is elliptical in form. The plan closely resembles the church at Bethlehem, but, as we have seen, apsidal-transept churches were a favourite form in the East during the tenth century. This type is found again in St. Fedele, Como, the Duomo, Parma, and several German Romanesque churches. Pisa

* *Arte Pisano*, 1904.

is one of the great churches of the world. Its distinguishing feature is that of being built throughout of marble, yellow-white alternating with bands and inlays of dark green. Fine sculptured shafts which flank the west door are exquisite alike in workmanship and design, and most difficult to account for in the filiation of style. They appear to be the work of a Greek long settled in Italy, possibly from the Venice or S. Italian schools, urged on by Pisan energy and rewards. Above the lowest storey rise tier upon tier of arcades standing free from the walls, and sharply defined on the shadowed background. The church is surrounded by a broad paved platform, on which it seems to rest, like a great ivory shrine. The bronze doors entering the south transept are wonderful for the vividness and force of the composition and execution of the figure groups. The many-columned interior is most impressive. The transverse arches under the dome are pointed. The small columns of the façade are of precious marbles, and the spandrils and other points of interest are inlaid with mosaic. This parcel mosaic work is parallel to that known as Cosmati work in Rome: both are derived from Greek sources. The tall blind arches of the ground storey recall Armenian work. R. de Fleury and Dehio have brought forward theories that the plan is the result of an alteration of scheme; but with this view Supino does not agree, he thinks it was laid out as we see it from the first. The first master of the works was Buschetto, who was followed by Rainaldo, who completed the church early in the twelfth century. It is a much argued point whether Buschetto was or was not a Greek as reported by Vasari; but of the Byzantine influence there cannot



Alinari

PISA CATHEDRAL. DETAIL OF BRONZE DOORS

Face p. 104

be a doubt, and yet it is a work of wonderful originality "in which elements Byzantine, Lombard, Arab, are fused into a new and simple whole." (For doors see Plate 20.)

The circular baptistery, which stands on the same axis as the cathedral, to the west of it, was founded in 1153, the master in charge of the works being Diotisalvi. It is nearly a hundred feet in diameter, with an inner arcaded ring on fine granite columns, said to have been brought from Elba. These support an upper gallery and a dome, or rather cone. The exterior has been much modified by a later addition above what was the aisle roof. There are four doorways, which open north, south, east, and west, and are adorned with beautiful sculptures. On the jambs of the east door are panels of the occupations of the twelve months and other subjects. These are strikingly Byzantine, a David being figured just like a Byzantine emperor. The lintel shows the Baptism and other scenes from the life of St. John. This is clearly modelled on a late Roman sarcophagus front. Above, in a row, are half-figures of Christ, Mary, and John, and four angels and four evangelists alternately; at the ends are palm-trees. The shafts on either hand are carved like those of the west door of the cathedral, and are equally beautiful.

The great cylindrical campanile was begun by Bonauo in 1174. Above a solid storey there are six stages of open arcades like those of the church. It may be said to have been designed by rolling up the west front of the cathedral. The whole magnificent group of buildings stands in a flat grassy close on the outskirts of the town, and is seen shining against a background of the marble mountains from whence they were hewn.

Perhaps earlier than the cathedral, and of more interest, in that it has been less restored, is the Church of San Paolo on the south bank of the river. This is a plain T-shaped basilica, with a dome over the crossing and an apse to the east. The west front is arcaded like the cathedral, and not having been scraped, the colour of the yellowed marble, set off with strips of dark green, shows how necessary to a building is its own skin. Some little carvings above the door might be of ivory. This façade

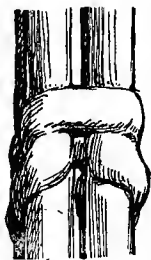

FIG. 53. Grouped shafts from St. Michele, Lucca.



FIG. 54. Panel from the front of St. Paolo, Pisa.

and the dome probably date from 1118-1148. The arcade of the interior has pointed arches which may be dated *c.* 1050.

The Pisan style, as we have said, differs from the Florentine in the use of solid marble instead of casings, but it was undoubtedly influenced in some respects by the latter. For instance, the curious type of panel found in the tympana of the arches, which has been called the Pisan Lozenge, and which is formed of a series of bands recessed one within another, is evidently a translation of the inlaid panels found in similar positions in Florentine

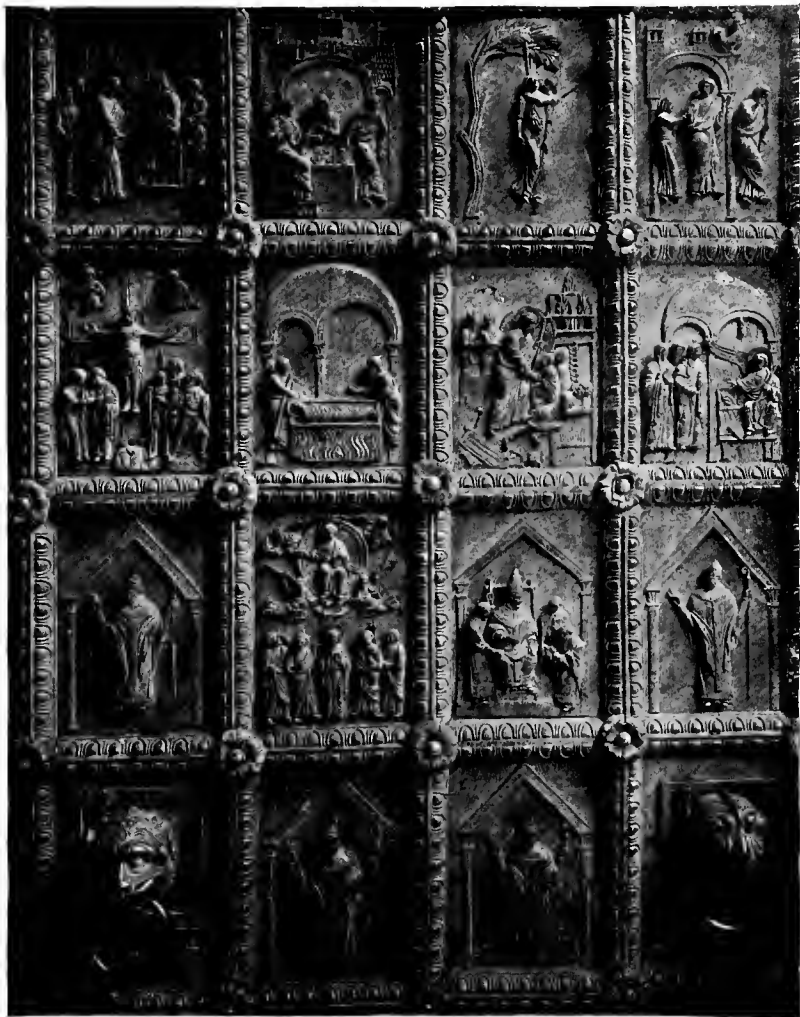

BENEVENTO. DETAIL OF BRONZE DOORS

work. In the first place these panels come from the East ; in Fig. 52 those on the left are from St. Miniato, and those on the right are from Salonica.

Lucca and Pistoia follow Pisa, but in Lucca the Lombard influence is more marked. At San Michele, Lucca, the marble structure is inlaid all over with an extraordinary complexity of ornament, knot-work, foliage and beasts. This front is said to be the work of Guidetto, at the end of the twelfth century. As points of proof that there was Greek influence at work in the Pisan school, I give rough sketches of intertwined pillars from San Michele, Lucca, and San Paolo, Pisa, and also the David panel from the baptistery at Pisa. The school of Pisa was so much enamoured of tiers of slender arcades screening the solid wall that the gable of San Michele, Lucca, is carried up some thirty or forty feet higher than the roof proper only for the purpose of providing room for more arcades, and to serve as a wide basis for a colossal statue of the Archangel. Apart from this exaggeration, one surpassing source of mystery and beauty which could be obtained in no other way was dis-



FIG. 55. King David from sculptured jamb of the Baptistery, Pisa.

covered and made available by this means. As the sun lights up the ranks of free-standing arcades, their sharply defined shadows are thrown against the marble wall behind, so that arcades of light are countercharged against arcades of shadow, while an infinity of intricacy results from perspective and from the ever-moving ranks of shadows. At San Michele, Lucca, the glittering of the twisted, sculptured, and inlaid columns accentuates still further this bewildering effect. Fig. 56 shows some of these patterns. The Lucca inlays are translations in local marble of the

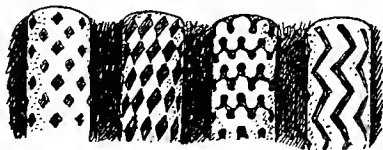

FIG. 56. Examples of inlaid marble pillars from St. Michele, Lucca.

Pisa mosaics. Originally the free standing arcades are derived, I believe, from open arcades of small scale, which were often used round the top storey of the exteriors of apses forming galleries.

Up to a comparatively late time all that we can properly call Lombardic is the more barbaric element found associated with the current Italo-Byzantine style of Northern Italy. Sant' Ambrogio, Milan, and San Michele, Pavia, are remarkable structures in that the walls and points of resistance are more exactly organised for the work they have to do than in churches of the basilican type. The nave and aisles are both vaulted, and the high vaults are supported on diagonal ribs. Such churches, it is evident,

form important links in the transition to Gothic; and about the vaults of Sant' Ambrogio have raged most violent blasts of controversy, especially since French writers have seen in such "ogival vaults" the particular mark of Gothicness. For long it was claimed that Sant' Ambrogio in its entirety was not later than the ninth century; on the other hand, recent French writers have asserted that the vaults are "frankly Gothic," and were built in the twelfth century, according to a new method imported from France. The only certain dates known are that of the altar made in 835, and of the campanile, which dates from 1129. The most recent Italian authorities (such as Venturi—"Storia dell' Arte Italiana," 1903, who cites Stiehl, 1898) accept the view that the vaults are of foreign fashion derived from Burgundy, and were about contemporaneous with the campanile, and, indeed, that the whole church in its present form, with the exception of fragments which have been re-used, belongs to this time. Later, in 1196, a part of the church fell, and at that time the ciborium of the altar was re-made, with beautiful pediment sculptures modelled in stucco. Sant' Ambrogio has a fine arcaded atrium, and its door jambs are highly decorated with interlacing patterns and other sculptures. The simplicity and large scale of the interior covered with its ribbed vault is most impressive. On the right and left of the Nave are two isolated porphyry columns, one of which supports a bronze serpent and the other a cross. The brazen serpent is called that of Moses, which indeed it represents, as the Old Testament type of the cross. On the left is a magnificent ambo, and in the centre of the apse the golden altar, with its ciborium;

around the apse are mosaics, of one of which I give a figure from a drawing by Mr. Alfred Powell (Fig. 57).



FIG. 57. Figure in mosaic from the apse of St. Ambrogio, Milan.

The difficulty as to the remarkable vaults of Sant' Ambrogio is hardly lessened by the view just set forth, because if the campanile was built in 1129, it is reasonable to suppose that the main body of the church would have been completed before this annexed feature was begun, and that therefore the building of the church must date from early in the twelfth century, and it is doubtful whether any ogival vaults can with certainty be pointed to in Burgundy or the Ile de France before 1120. The vaults of Sant' Ambrogio are, moreover, no timid experiments, but of large span and boldly executed.

As we shall see, however, in the next chapter, the Norman school, which seems to have been in close contact with that of Lombardy, was in possession of this method of erecting ogival vaults before 1100; and it

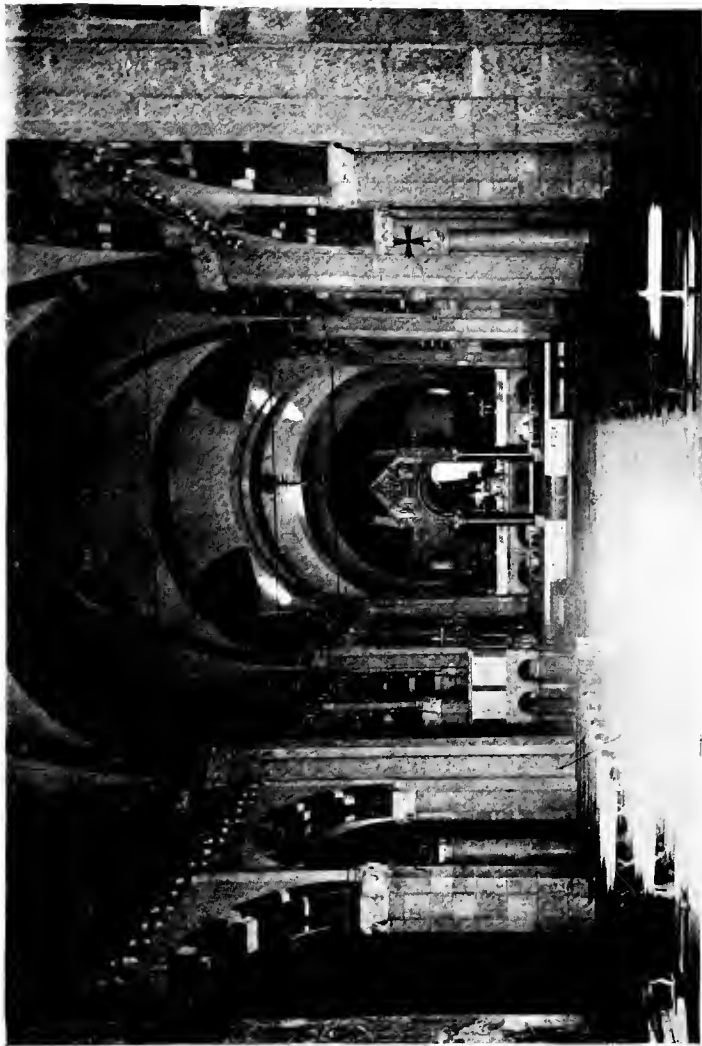

MILAN. INTERIOR OF SANT' AMBROGIO

seems that, on the evidence, we are compelled to suppose that Sant' Ambrogio derived its scheme of construction from Normandy. It may be that the origin of the ogival vault is to be sought for in Normandy, or even in England; but there are many reasons for thinking that the seed idea, like so many others, came from the East. (Pl. 22.)

Choisy says that ribbed vaults (of small scale) were known to the Arabs one hundred and fifty years before they appeared in the work of our church masons. He cites and illustrates as examples of *Voutes sur nervures* the chapel in the mosque of Cordova, and from Armenia the narthex of the chapel of Akhpat. Street, in his book on Spain, describes and illustrates the mosque at Toledo, which he says is known to have been already in existence in 1085, and was practically unaltered when he saw it. It is a square divided into nine small compartments, each one being vaulted with rather intricately ribbed cupolas—"a little vault with intersecting ribs thrown in the most fantastic way across each other and varied in each compartment." Again Street, in his account of the Templar church at Segovia and the Chapter-house at Salamanca, shows that ribbed cupolas were erected in churches (in the twelfth century), which certainly derived the disposition of their ribs from Moorish examples. The Moorish and Armenian examples are none of them quadripartite vaults, and they are of comparatively small size; they do, however, furnish the principle of supporting vaults by independent ribs. As to the true ogival form it is to be pointed out that the most characteristic form of Byzantine vault from the time of Justinian was the cross-vault which did not form level penetrations but rose toward the centre, thus forming

domical cross-vaults. This is just the type followed (with the addition of ribs) by the earliest ogival vaults. As for ribs, the dome of Sta. Sophia is not a plain surface within, but is thickened at intervals by wide projecting ribs. Now we know that this dome was rebuilt in the

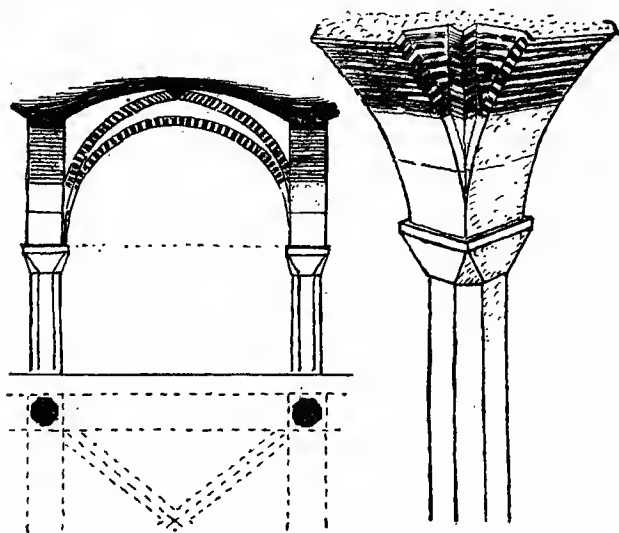

FIG. 58. Ribbed vaults from the church of Skripou in Greece.

last quarter of the tenth century: and an Armenian chronicle cited by Schlumberger says that this was done by an Armenian architect, Tirdates. I find, moreover, that in the Byzantine church at Skripou the vaults have diagonal ribs of brickwork. This church is probably of the eleventh century, as we have seen. I give in Fig. 58 particulars of these vaults, kindly furnished to me by Mr. Schultz.

The church of St. Benedetto, Brindisi, in the centre of the Byzantinised part of Italy, has ogival vaults. And of about the same date in the choir-vaults of Cefalú Cathedral, in Sicily (begun *c.* 1132) diagonal ribs appear; the mosaic work passes over them, as over the cells between, but there is every reason to suppose that here, too, they are structural.* These examples, and doubtless many more could be adduced, seem to point to the East as being the birth-land of this form of vault; and it may even be possible that the S. Italian and Milan vaults were independently derived from Byzantine vaults rather than from Normandy, especially as their ribs are of brick, like those in the East. Eastern stalactite vaulting may be a branch development of similar experiments. The derivation of Western ogival vaults from Eastern ribbed cupolas would fall in with the fact that the Angevin vaults, which seem to be just as early as those of the Ile de France, are rather ribbed domes than cross-vaults.

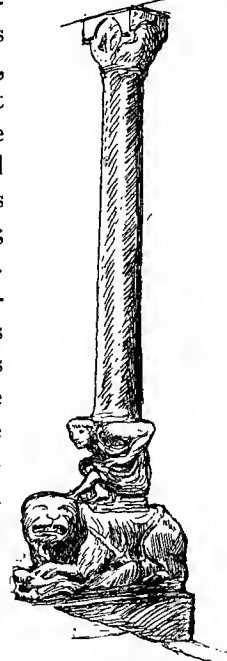

FIG. 59. Pillar from the crypt of Modena Cathedral.

When a well-defined school of art, distinct from the Italo-Byzantine, arose in Lombardy in the eleventh and twelfth centuries, the mixture of barbaric elements in the ornamentation gave to it a wonderful liveliness of fancy and an expression of struggling energy.

* All these Italian ogives may prove to be derived from France.

The walls teem with dream-fancies of knotted dragons and fighting men, while the pillars rest on great lions tearing their prey (Plate 16 and Fig. 59).

I can here do no more than name some chief centres where characteristic examples of this vigorous school of art are to be found, Cremona, Aosta, Verona, Como, Modena, Parma, Piacenza, Ferrara, Borgo San Donnino, and Cortazzone, and refer to Venturi's fully illustrated pages.

Much has been written about a school of "Comacini Masters," who are supposed to have carried on architecture in North Italy, and to have been responsible for the supposititious school of early Lombard art; but it is generally held by scholars that the word does not refer to a centre at Como, but should be understood as signifying an association or guild of masons, and that the *Magistri Comacini* heard of in the seventh century were of no special importance. It does seem probable, however, that the expansion of N. Italian art over many parts of Europe, which appears to have taken place in the eleventh and twelfth centuries, may be traced to the fact that in Italy the guilds had privileges which made members free to travel at a time when Western masons were attached to manors or monasteries.

In the twelfth century a new phase of art appeared in Rome. There had been an interval of some two centuries when mosaic working seems to have been forgotten. The mosaics of San Clemente, S. M. Maggiore, and S. M. Trastevere are the first of the new school. Many pavements were also wrought of morsels of porphyry and

precious marbles, for the most part obtained from antique columns, and arranged in patterns, taking usually the form of meandering bands surrounding discs, in a style of work usually called "Opus Alexandrinum," but parcel mosaic might be more explanatory.

Similar mosaic, but smaller in scale, and with gold tesserae added, was also much used for pulpits, bishops' thrones, altar tabernacles, and Paschal candlesticks, being set in panels and bands sunk in the marble. This work, for which Rome became famous, was widely distributed, especially in the South. It has generally been called Cosmati work—from Cosmas, one of a family of marble-workers. This family, however, was not the first to practise this form of workmanship. Works were already described at this time as being decorated "Romano opere et maestria." In one inscription the artists are called "Magistri doctissimi Romani." A master who was brought from Rome to make the marble-work for Edward the Confessor's shrine signed himself thereon "Civis Romanus," and exactly the same formula occurs at Corneto and at Civita Castellana. Examples of this work are found which were executed in the first half of the twelfth century.* Peter and his brother Nicholas, followed by the son and grandson of Nicholas, worked at Corneto from 1143 to 1209, and Paul and his four sons made the tabernacle in Saint Laurence outside the Walls, beginning in 1148. Cosmas, mentioned above, was working in the first years of the thirteenth century. Still another chief of a school was Vařalletti, whose inscription, signing the cloisters of St. John Lateran, has recently been found, and

* A late example of this work is given in Fig. 122.

the candlestick of S. M. Cosmedin, was the work of a certain Pascal, "vir doctus et probus." The first artist of this Roman school of which we have any knowledge was one Paul, who was working about 1100.

Pavements of "Opus Alexandrinum," similar to those in Rome, which are found in many Byzantine churches, must have been the point of departure for the Roman art. Mr. Frothingham in the *American Journal of Archæology*, 1894 and 1895, has made a careful study of this point, and has proved that the Roman art originated as one branch of Byzantine art, which at about the same time formed schools in Venice, in Rome, and in South Italy and Sicily; while in the East a parallel development was taking place in Coptic work. Some wall-mosaics of the eleventh century at Daphne, by Athens, which are of this kind of marble work, have lately been cited as further evidence by Millet, and the beautiful pavements at St. Luke's monastery should also be referred to in this connection. To have strictly followed the productive influences I ought to have grouped Rome and South Italy with Venice as centres of new life in art, and I may once more point out that the decorative use of mosaic at Pisa and the marble inlays of Florence and Lucca may be traced back to Byzantine originals.

The bronze gates of St. Paul's outside the Walls, made in Constantinople by Staurachios in 1070, still remain a memorial of the artistic suzerainty of the Greeks at this time. There are others of the same origin and of about the same date at St. Mark's at Venice, Salerno, Amalfi, and four or five other places.

Another artistic dynasty that must be mentioned is



SICILY. CLOISTER OF MONREALE

that of Sicily under the Normans. The Saracens held Sicily from the ninth century until Counts Robert and Roger won it for their own, and during this time there was such an immigration of Greeks as to amount to "a second Hellenisation" of South Italy. Bertaux illustrates the remarkable *Cattolica* of Stilo, a little cross church in a square, with five high domes, which is of so eastern a type that it would look at home in Persia. At Otranto a crypt is supported by beautiful columns engraved over with patterns said to be of the ninth century. The Normans at once entered into the Græco-Arab civilisation of South Italy, and in their large way patronised art. The divers elements in the blood of this art—Arabic, Greek, and Northern—soon produced a magnificent school: bold, yet refined; simple, yet glittering and splendid. Its great monuments are the Cathedral of Cefalù (1132), the Palace Chapel at Palermo (consecrated 1140), the Abbey of Monreale (built from 1174 to 1182), and the Martorana, Palermo (1184-1221). In these buildings Damascus, Mount Athos, Rome, and Cluny seem to make equal contributions to a dream-story of architecture. The Palatine Chapel has a domed sanctuary joined to a basilican nave; the ceiling is Arabic and the walls are covered with Greek mosaics; while the inscriptions are in Arabic, Latin, and Greek. The Martorana still shows the remains of a complete scheme of Byzantine mosaics. The abbey church of Monreale is of great size, a basilica of about 330 feet long, all encrusted with marble and mosaic. The semi-dome of the apse is completely filled by a colossal head and shoulders of Christ. This figure, which rises, as it were,

behind the level cornice at the springing of the conch, as seen in the shadow, is one of the most wonderful conceptions of art. The nimbus of the head must be some seven or eight feet across. Below, of more normal scale, are enthroned the Virgin and Child between two Archangels, and the Apostles follow. At the side of the church is a cloister of marvellous beauty, the marble columns of which are all exquisitely carved or inlaid with mosaic; and in one angle is the fountain known to every one. (Pl. 23.) Some of the carved columns of this cloister are, although smaller

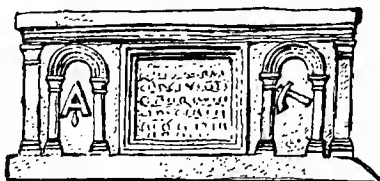

FIG. 60. Tomb of two masons, *uno animo laborantes*. Of the seventh or eighth century. Now in a museum at Venice.

and later, so much like the door-pillars at Pisa spoken of above that I am inclined to think that the Pisan carver must have come from South Italy. To the west and north of the church are bronze doors. The north doors are the work of Barisanus of Trani, who, about 1179, wrought similar bronze doors for Trani and Ravello. The western ones were made in 1186 by Bonanus of Pisa, whose name may still be read on them. Plate 21 shows similar doors at Benevento.

On the mainland, in the south of the Italian peninsula, at Bari, Otranto, Bitonto, and other places, are to be found works conceived in a style mixed of Sicilian and



BITONTO CATHEDRAL. EXTERIOR GALLERY

Face p. 118

Lombardic elements, and of extraordinary beauty and vigour. (Plate 24.)

Many memorials exist of the individual artists who worked in Italy during the times with which we have been dealing (Fig. 60), but I reserve what is to be said in regard to mediæval craftsmen to a later page.

If I have here seemed to insist overmuch on the Byzantine factor in Italian art, it may be urged that I have only applied in detail the truism that during the earlier Middle Ages Constantinople was the artistic capital of the world. Until about the year 1000 there was little in Western art beside Byzantinism and barbarism, and up to this time the products of the various schools might better be called Byzantesque than Romanesque.

CHAPTER V

ROMANESQUE ART IN GERMANY, FRANCE AND ENGLAND

IN Gaul, early Christian art was a provincial variety of the art of Rome. In the fourth century organised Christianity spread over the whole country and reached Britain. At Sion an inscription mentions the repair of a church in 377, and the foundations of the church at Silchester in Britain must go back as far. The most ancient existing church in France is the Baptistery of St. John at Poitiers, which dates from the sixth century; and at Grenoble and Jouarre there are remnants of seventh-century works. Although the remains are few, records show that great churches existed in all the important cities of Gaul—at Lyons, where the church is described by Fortunatus; at Tours, where the basilica of St. Martin was rebuilt about 472; at Paris, where the basilica of Sts. Peter and Paul was built by Clovis; and at Clermont, where a basilica is described by Gregory of Tours. At Nantes, in the sixth century, above the centre of a church rose a high structure richly painted, and probably of wood, “like the peak of a mountain”; and such spirelike pavilions seem to have been general in Gaul. A large number of the early

churches were of wood. Towers proper were attached to churches from the fifth or sixth century. If annexed, they were usually square; if isolated, circular, like the round towers of Ireland. The interior walls of the main building were covered with paintings, as was the case in the churches at Jarrow and Monkwearmouth, built by Benedict Biscop. The floors were frequently of mosaic, and polished marble columns were obtained where possible. The high altar stood under a ciborium; beneath the altar was the *confessio*; and across the triumphal arch rested a beam, which carried the cross, candles, and relics. The later ornamentation, both in France and England, was a variety of the Byzantesque styles. We have at Bricksworth, Northamptonshire, the remains of a fine basilican church of the seventh century.

The rising of the Carlovingian dynasty marked a period of transition in the arts corresponding to the political and social changes of the time. Roman traditions in Western Europe had fallen into almost complete decay save for the infiltration of Byzantine elements. The coming of the Franks also brought an element of barbarism. The school of art fostered by Charlemagne formed a rallying-point, and, directly from the East as well as by contact with Ravenna and Rome, it absorbed influences which were afterwards distributed over Germany, France, and even Lombardy. The church at Aachen, built 796-804, as a national monument, and attached to Charlemagne's palace, is the most typical building of the epoch. It was built by Master Odo of Metz. An octagonal central area is surrounded by an aisle sixteen sided to the exterior. A fine vaulted gallery surmounts

the aisle, and the centre is covered by a dome. A projecting porch to the west, with two large staircases, rises high above the aisle. The original eastern termination was destroyed when a fine Gothic choir was begun in

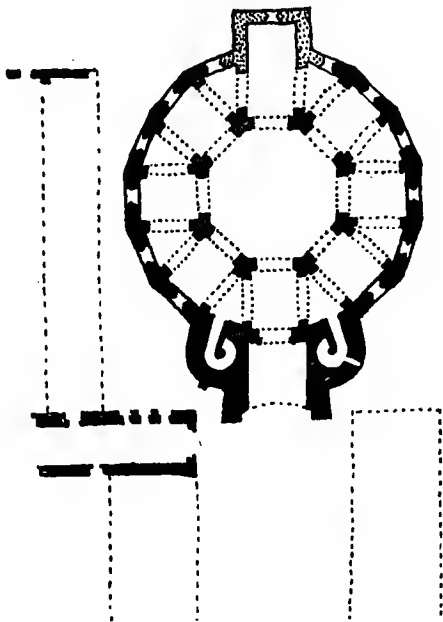

FIG. 61. Plan of the Palatine Church of Aachen.

1353. Its foundations have been found and show that it was square-ended and small. The altar and ambo cannot have stood here, but in the east part of the central area.

A collection of ancient materials was brought from Theodoric's palace at Ravenna, and re-used in the structure, and some white marble capitals still surmount

the external pilasters. The dome was covered with a mosaic of Christ and the twenty-four elders: Ciampini has given an engraving of this, the Elders had risen from their thrones to offer their crowns to Christ. Above were the Evangelists, and the field was set with stars:* the floor was also of coarse mosaic. Bronze balustrades which fill the openings of the gallery are of great beauty, and appear to be more ancient than the church. There are also bronze doors, and in the porch is preserved a bronze pine-cone three feet high, which probably stood in the atrium, forming the fountain, like the more celebrated pine-cone at old St. Peter's. It bears an inscription referring to the four rivers of Paradise and is said to be of the tenth century. It was given by Abbot Udalric, and bears an inscription referring to the Eden Spring—"the source of all waters which flow on earth [Gihon gently flowing]: Pishon holding gold: Euphrates fertilising the land, and arrow-swift Tigris: Abbot Udalric piously gives thanks to the Creator." Altogether this is a most impressive building, and is in many respects carefully constructed, especially in the vaulting of the aisles and of the gallery. In the latter the alternate compartments rise at an angle against the central octagon, so as better to support the great dome. The masonry closely resembles Theodoric's tomb. Dr. Strzygowski in a recent study of this monument shows good reasons for thinking that the church is not to be regarded as a mere imitation of St. Vitale, but that it is one of a series of buildings belonging to the "Central type" built under Eastern influences. He supposes the upper storey of the west porch

* These mosaics were destroyed in 1719.

to have had an opening like the balcony of Syrian Churches, and that the circular stair-turrets on either hand rose as towers. He supposes that the bronze balustrades of the interior as well as the bronze doors were made for the position they now occupy; in any case it is known that there was an important school of bronze casting established at this time in Germany. At the present moment prodigious "restoration" works are in progress.

Another monument of this age is the gateway of the Abbey of Lorsch, founded in 764. This gateway may probably be dated about 800.

The well-known plan of the monastery of St. Gall, a great church with apses east and west, and two round towers, also belongs to this time. It is especially interesting as giving us the disposition of the buildings in a large monastic establishment in the early Middle Ages, and shows how, even at this time, the type had become fixed. The church has transepts, giving it the cross form.

In France, the remarkable Church of S. Germigny des Prés, a square with semicircular projections on each face, and a lantern-tower rising on four piers over the centre, consecrated in 806, and the old nave of the Cathedral of Beauvais, built in 987-998, are the best examples of the Carolingian proto-Romanesque.

In the German Empire, especially along the Rhine, there was a great revival of art from about 975 to 1000, following on the introduction of Byzantine artists by Otho II., who married Theophania, daughter of Romanus II., the Emperor of Constantinople, in 972. This Germanic-Byzantine style is sometimes called Othonian, and it affected every branch of craftsmanship, especially miniatures



THE GLOUCESTER CANDLESTICK, c. 1110

Face p. 124

of manuscripts, ivory carvings, and bronze casting. Several monuments of the time of the Emperor Henry II. (died 1024) show the height to which this school of art attained. On the right hand of the choir of Charlemagne's church at Aachen stands as a pulpit the ambo, a work of great beauty and splendour, given to the church by Henry II. It has panels of carved ivory, surrounded by silver-gilt borders, set with cameos and jewels. It is inscribed *HOC OPVS AMBONIS AVRO GEMMISQVE MICANTIS, &c.* The carved ivory panels are early Christian work from Alexandria.

The bronze-works of Hildesheim also belong to this period. These are the famous doors with panels of figure reliefs, and the large spiral pillar ornamented with a continuous ribbon of Bible stories, at the foot of which the four rivers are poured out of vases. These were wrought under Bishop Bernward in 1015-1022. The very beautiful seven-branched candlestick at Essen, the branches decorated with open-work knops, and terminated with flower-shaped nozzles, should also be mentioned. It seems to figure in a symbolic way the Tree of Paradise in the centre of the world, for around the base are little images of the quarters—*ORIENS, OCCIDENS, AQUILO*—the fourth being lost. The Gloucester candlestick, now in South Kensington Museum and given to Gloucester early in the twelfth century, is, I think, an example of this German school of bronze working. If a book illustration is to be trusted there is at Hildesheim a candlestick almost exactly similar called Bernward's. The wonderful thirteenth-century candlestick at Vienna with seven branches and open-work foot and stem is clearly allied to the school represented by the Gloucester candlestick, for which see Plate 25.

The great bronze-working school of Huy and Dinant, which produced remarkable works early in the twelfth century, and became the pre-eminent market for them, must have been an offshoot of the Othonian art-dynasty. The monk Theophilus, the earliest systematic writer on the arts of the Middle Ages, who probably wrote at the end of the twelfth century, and in whose work a large share of Byzantine tradition survives, seems to have belonged to this Rhenish school of art, which, in the two centuries following the time of Charlemagne, was the chief on this side of the Alps; and from it was largely derived the art of England during this time.

The next impulse upon Germany was to come from Lombardy, the nearest Italian neighbour state, where, as we have seen, great stirrings in art were manifesting themselves from about the year 1000. The eleventh and twelfth-century German buildings, especially along the Rhine, at Cologne, Mainz, Worms, Speyer, Bonn, and many other places, closely resemble Lombardic work.

As early as 1107 there is a record in the chronicle of the Abbey of Rolduc, in Hainault, that its crypt was built *scemate Longobardino* by Brother Embricon and his friend, who came from the environs of Tournay. Lombard masters about this time seem to have been called to work all over Europe. Bayet says that Lombard masters built a Russian cathedral in 1138-1161, and we are told how St. William soon after the year 1000 took Lombardic artists to Dijon and Normandy. Again, Street cites a Spanish document of 1175, in which Raymundus Lam-

bardus, with four other *lambardos*, agreed for certain works at Urgel—surely these too are Lombards.

In Italy itself the Lombards seem to have been in request; a record shows that certain building work and sculpture at Treviso was executed by Pietro Lombardo and his sons.

Lombardic work is doubtless to be found in many places outside of Italy. There are scattered widely over Europe, from Vienna to Gloucester, and from Lund in Sweden to Spain, many buildings strikingly similar in some respects of detail to Lombard buildings. And there was a greater uniformity of style in building in the twelfth century than at any other time. Probably the Lombard masons worked under conditions which made it easy for them to travel, and this may in part account for the requests made for their services, and for the wide circle of their influence.

The most typically German characteristic is the use of double apsidal terminations, accompanied by a western as well as an eastern transept. Such double-ended churches early arose in the East, as we have seen, in consequence of changing the direction of churches which at first had their doors to the east and apses to the west. Our own Canterbury, in the tenth century, was an example. In Germany, as early as the time of Charlemagne, this type was adopted irrespective of its original cause, and was followed in the plan of St. Gall.

The noblest church of this form is Mainz Cathedral. The east choir dates from about 1100, and the western choir, which is of trefoil form, is a century later. There is a lantern-tower over each crossing, and four other towers. Without and within, notwithstanding much

restoration, this is a superb building, sombre and strong, and built of a beautiful reddish stone.

Another characteristic Rhenish plan is that in which the transepts as well as the eastern limb have apsidal terminations. This plan also, as before said, was a favourite form in the East. St. Mary in the Capitol, Cologne, consecrated in 1049, is of this kind; so is the Holy Apostles, in the same city, and St. Quirinus, at Neuss. The latter is a fine late Romanesque church, not finished till the thirteenth century. We have seen that in North Italy there are some churches of this form, and that it is ultimately to be traced to the East. It was doubtless introduced into Germany on the great wave of Byzantine influence which flowed in in the time of Otto II. (Plate 26.)

A third characteristic feature is the use of tall towers, generally in pairs, rising at the re-entering angles of the transepts, closely resembling Lombardic campanili. This Romanesque style formed the typical German expression in architecture, and German builders are found again and again reverting to it, long after the introduction of Gothic from France in the middle of the thirteenth century. It is a fine building-style, especially happy in the massing of parts; but in detail a little dry, and lacking in sculpture.

The harshness of style was doubtless entirely modified by extensive schemes of painting (for example the splendid ceiling at Hildesheim), and by many noble bronze furnishings—light coronæ, vessels, and doors.

The Romanesque church, with its transepts and square lantern-tower rising over the crossing, is only another version of the Eastern scheme of building, the lantern-tower taking the place of the high central dome.



COLOGNE. CHURCH OF THE APOSTLES

Face p. 128

Lombard and Rhenish influence is evident in many centres of early French Romanesque. In the South-west of France in the eleventh century there was a school which definitely followed oriental models, doubtless directly derived from over-sea. From the admixture of these influences with the earlier traditions issued in this new time of growth many lovely varieties of building. St. Front, Perigueux, is the most famous example of the South-western school of Perigord: it dates from about 1100. But there are other examples of the same type still earlier. St. Front is a cruciform domed church something like St. Mark's, Venice, from which it is often said to have been copied, but it is even more like St. Barnabas in Cyprus, and rather seems to belong to a series of churches built under Eastern influence—a southern wave of Byzantinism spreading along the shores and over the islands of the Mediterranean, Cyprus, Crete, Sicily. Street refers to two or three churches in North Spain which are stone vaulted, and which he thinks may belong to the tenth century. One of these, a small church, has the transverse triapsidal plan which I think clearly shows the influence of the secondary Byzantine style. In the Spanish churches the central lantern often remained a *dome* till late in the Middle Ages. In the main we shall I believe, find that French Romanesque had its roots in the Rhine and the Mediterranean, and that certain centres were also influenced directly from Lombardy.

Since the above was written, Mr. A. G. Hill has described four remarkable early churches in North Spain; three near Oviedo all built, it is said, by one Tioda, in the middle of the ninth century in a "Latino-Byzantine" style, and the

other, Santiago de Peñalva, a Moorish building of the tenth century which has apses at each end. Two of the former are very small *cruciform* structures with round *barrel-vaulting* and western galleries. "The sculptured capitals have strong Byzantine feeling." We may regard it as certain that on both sides of the Pyrenees there was an early school of Byzantinesque church building, and that the Romanesque school of the South of France derived much of its inspiration from this source.

In the South-east there was another school, the most characteristic mark of which was its surface decoration by bands and patterns of cut-stone of divers colours. Issoire is a fine example of this kind. The well-known church of Le Puy follows the Perigueux form, but it is treated in the manner of Issoire, for which see Plate 27.

Towards the end of the eleventh century many magnificent Romanesque churches were built in France. One of these is S. Sernin, Toulouse, begun *c.* 1075, and of which the eastern limb was consecrated in 1096. A companion church over the Spanish frontier is S. James of Compostella, begun *c.* 1080.* The fine churches of Conques, Brioude, and Mauriac also belong to this school, as does, in many respects, Cluny, the great central monastic establishment of France. In 1089 St. Hugh commenced its reconstruction on a vast plan; in 1095 the choir was terminated; and the church was dedicated in 1131. The architects were two of the brethren, Hézelon of Liège

* There is the closest resemblance between St. Sernin and St. James. A recent Spanish author claims that the Compostella church is the earlier and shows more of Byzantine influence: he dates it 1074 or 1075, and St. Sernin, 1080.



ISSOIRE. VIEW OF CHURCH FROM THE EAST

and Gauzon. About 1220 was added the vast narthex. It was a five-aisled church, with a secondary transept eastward of the main crossing, an apse, and radiating chapels. Double chapels opened from the great transepts. A lantern-tower rose over the crossing, surrounded by three others, one on each arm of the main transept, and one over the east, or minor, crossing. The interior was of great height and entirely covered by vaults, that of the nave resting on transverse arches. The narthex was like another three-aisled nave, and was terminated at the west by two big towers. The line of style development and persistence passed through Toulouse and Cluny.

In Normandy large works, well built and proportioned, were being produced about the middle of the eleventh century. Jumièges was begun about 1040. Bernay, which dates from 1015 to 1050, belongs rather to the anterior school. Domfront (c. 1050), St. Nicholas (c. 1062-1083), and also Holy Trinity (1062-1072), both in Caen, have simple groined vaults over the choirs, a most important development in the course of Northern architecture. Here the vaults do not follow the barrel-vault type found in the early churches of the South-eastern part of France, but they are cross-vaults allowing of the penetration of clerestory windows in each bay. It is this relation of vault and window which was one of the early steps leading up to Gothic. The abbey church of St. Stephen, Caen (1064), is so planned as to show that high vaults over the nave were contemplated at the first, although the scheme was afterwards abandoned. Ruprech Robert, the historian of Norman architecture, has no doubt

that the main principles of early Norman construction were brought from Lombardy, especially by the influence of Lanfranc, the Prior of Bec, from 1045, but although a Lombard influence might account for much it will not account for the vaults. The application of vaults to central spans was first made in the schools influenced from the East over the Mediterranean; the cross high-vault was a Northern adaptation which was found to be convenient for giving window space. (The high vault of Tournus, once said to have been erected as early as 1019, is now dated 1066-1107).

The next great step, in which we find the completion of the Romanesque style, and the opening of the immediate transition to Gothic, was made by reinforcing these simple cross-vaults with ribs under the intersections, forming thus the ogival vault. There are no vaults of this description now existing in Normandy itself which can be dated earlier than the middle of the twelfth century, but there is no doubt that, in the English branch of the school, they had by this time long been in use. Mr. Bilson has recently shown that, at Durham, ribbed vaults were used from the first building of the church, commenced at the end of the eleventh century. The vaults of the aisles of the choir, which still exist, were completed by 1096, and the high vault of the choir was built by 1104. It was removed; but the vaults of the transept (c. 1100-1120) and nave (c. 1130), the construction of which followed those of the east end, still remain. "Every part of the church was covered with ribbed vaulting between 1093 and 1133." There are also early twelfth-century ribbed-vaults at Gloucester, and the whole choir, built from 1089 to 1100, must have been designed for vaulting, as counter-

butting arches, to resist its thrust, cover the triforium of the choir. The same arrangement is found at Norwich (begun 1096). In the drawings which Carter made of the Priory of Holy Trinity, Aldgate, he gives details of a bay of early Norman cross-ribbed vaulting which can hardly be later than the rebuilding immediately following the fire of 1132. Mr. Bilson's study of the subject has created so much interest in France that Count Lasteyrie has brought such rebutting reasons as are possible against the claim; but the historical evidence for the building of Durham is so complete, and the sequence of vaults has been so clearly worked out, that there is no doubt that the claim for early ribbed vaults in England has been fully proved. Although it seems impossible to resist Mr. Bilson's conclusion generally, yet in the case of the highly developed vaults of Malmesbury, I cannot think that the proof for a date so early as "not later than the middle of the twelfth century" is made out. The vaults here are quite systematic with pointed transverse arches, and the nave arcade is also pointed. Work at the Abbey does not seem to have begun till some time later than 1142, and there is no reason to think that, even if the choir was begun *directly* after this date, the nave would be reached in six or eight years. Again, the elaborate sculptured south door and porch and the west door, can hardly be dated earlier than 1170-80, and although their masonry does not range with the main work, there are no indications, and I cannot think it likely, that there were ever earlier doors. I should say that openings were left out for those highly sculptured features which were built in at the end of the work. Notice that the elaborately carved porch-arch

with its Bible stories, and eight Virtues trampling on Vices, had dragon-headed terminations to the drip-mould similar to those of the nave arcade; they were reset in the fourteenth-century outer arch. We are not, I think, justified in supposing that the pointed arcade of the interior and the aisle vaults are earlier than *c.* 1160. They show, I consider, a knowledge of the solution arrived at in the Ile de France. The evidence for the use of the ogival vault in Norman England is clear, and without claiming that they were originated here, it is necessary to traverse Lasteyrie's statement that, if Norman, they *must* have been first used in the mother-land of the style. It is just possible that this method of construction may have been invented in England during the progress of the enormous volume of building which followed on the Norman Conquest. But, as said earlier, it is probable that at least the first principles of the system were obtained from the East.*

It is but a single step over an invisible line from Romanesque art to "Gothic" art; it would help us to realise this if the names we give these styles answered to the relationship of the arts, and it might be convenient to interchange the word "Romance" with Gothic.

* On Durham and early Ogival vaults, see Appendix.



MORIENVAL ABBEY CHURCH (c. 1125) BEFORE "RESTORATION"

Face p. 134

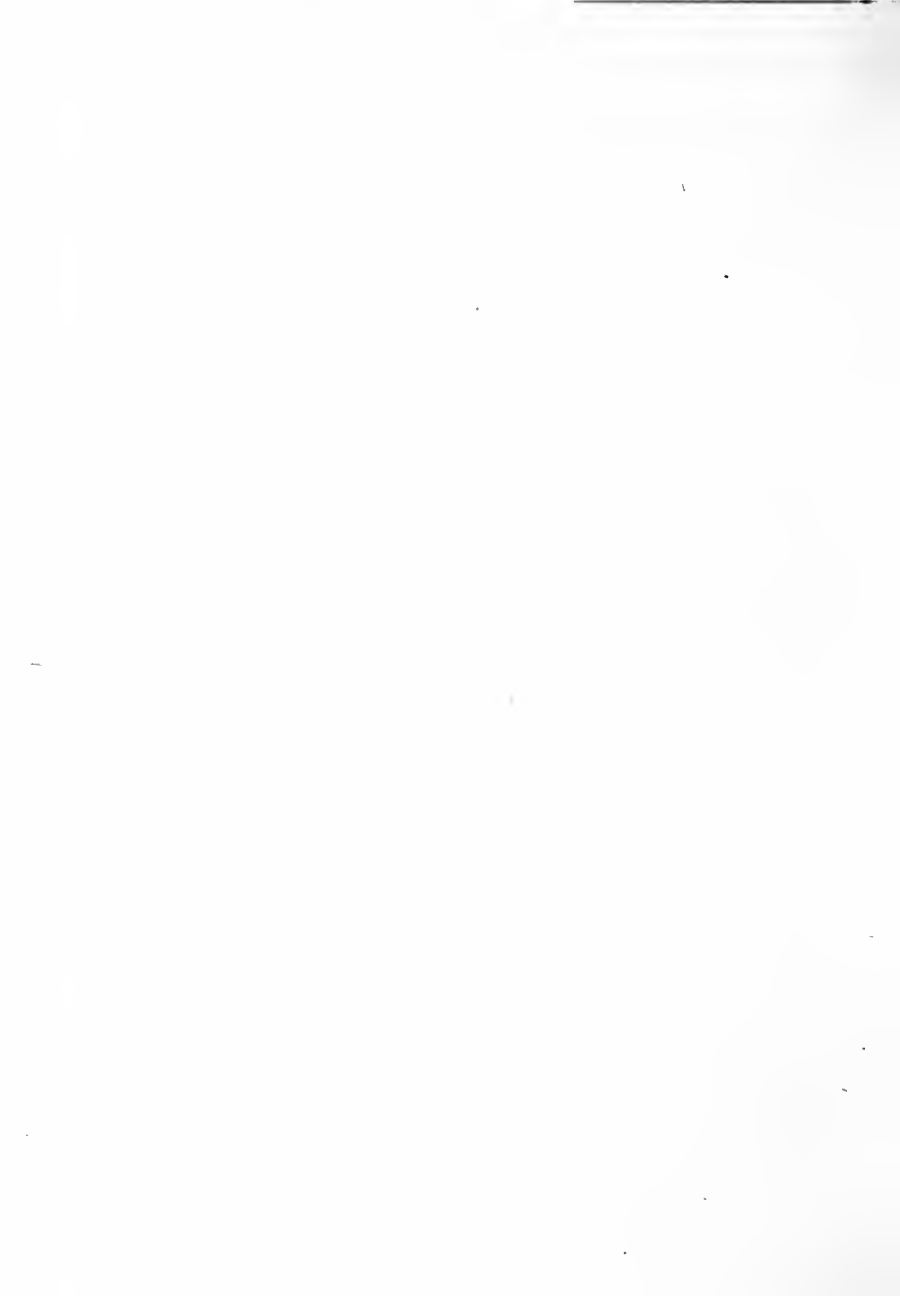

CHAPTER VI

OF ROMANCE ART

By Romance art I mean that art which is usually called Gothic; the art, especially of the North of France, which was developed from the Romanesque. The name of Gothic came into use in Italy at the Renaissance. Its origin may be traced to the fact that students at that time supposed that buildings of the earlier Middle Ages which differed from "the true Roman manner" were the work of the Goths who overthrew the empire. "Then," says Vasari, "arose new architects who, after the manner of their barbarous nations, erected the buildings in that style which we call Gothic." Under this name he groups buildings erected from the early Christian to the Romanesque periods. And the confusion became still greater when this word Gothic was extended to include the perfected mediæval buildings of France and England, and was withdrawn from the earlier styles. It is, however, in some respects a convenient name, and it agrees so far with the facts that what we now call Gothic is an art developed where a Teutonic people had built its civilisation upon the ruins of a Roman province. In the countries comparatively untouched by the Germanic invasions this art never found a home.

Romance art is but one of many expressions of the life of the Middle Ages, which may be imagined as a crystallisation of society, the several facets of which manifested, on the side of action, chivalry; in literature, the romances; a great enthusiasm and development in the Church; in learning, the establishment of the universities; and in civic life, the organisation of town communities and guilds. This same spirit, expressing itself through the crafts, is Romance art. It was born in the age of the Crusades, the time of "a culture not founded on knowing things, but on the art of doing things." It is not to be doubted that in all this France not only *led*, but *invented*, where others followed. In a very true sense what we call Gothic is *Frenchness* of the France which had its centre in Paris. If, among the neighbouring countries, the Gothic of England comes next, as indeed it does, it is because England was so far French. In the eyes of the Norman kings it must have seemed that their true capital was Rouen, and that England was but a conquered province. William the Conqueror, addressing the citizens of London, called them French and English. And the chronicler, speaking of the accession of Henry I., says that both French and English approved. Not only French art, but French thought and language in the thirteenth century held the predominating place in Europe. French tales of chivalry were everywhere read and imitated, and Brunetto Latini wrote his "Trésor" in French, "parce que la parleure est plus delitable et plus commune à toutes gentes."

In Italy itself the influence that was to transmute Lombardic art into the art of Assisi, Verona, and the

Florence of Arnolfo, came from France; some of the Cistercian monasteries are examples of almost pure French Gothic. In an interesting study of the development and character of Gothic architecture, Professor Moore has applied Viollet le Duc's canons to a comparison between French and English mediæval art; but in his search for a strict definition of Gothic he is carried to a conclusion which excludes most of the examples usually understood to be representative, and which, in its rigidity, is even, I venture to think, opposed to the true Gothic spirit. For instance, he asserts that it is "an architecture of churches only," when the traditional claim has been for the adaptability and inclusiveness of Gothic. It all follows, however, from the logical method employed, which may be paraphrased thus:—We shall best find the characteristics of Gothic architecture in the most perfect examples of thirteenth-century cathedral-building; and then, conversely, only buildings which show these highest characteristics are Gothic. It follows, naturally enough that—"Gothic architecture, as I define it, was never practised elsewhere than in France," and that even the Sainte Chapelle in Paris is only "strictly Gothic as far as it goes." On the other hand, a brilliant French writer in a recent study of Gothic says that the progress of architecture was a long battle between darkness and light, till at last the architect of the Sainte Chapelle in the pride of conquest built with light itself. So we choose our instances! Even in his special use of the word it does not seem benevolent—at least it is unscientific—of Mr. Moore to refuse to us any Gothic in England. He should surely allow us a half or quarter Gothic.

It may be granted that it would be convenient if we had a word which expressed "that system of balanced thrusts" which is best exemplified in cathedrals like Amiens; yet it is impossible at this time to divert the word "Gothic" to this limited use. "Ogival" might perhaps be made by agreement to serve the purpose.

Gothic architecture is but a subsection of Gothic art, and ogival cathedral-building is only a subsection of Gothic architecture. Indeed, it may be doubted whether Castle-Gothic has not been neglected in the study of the evolution of the style. Gisors, Château Gaillard, and Coucy are in no wise behind the cathedrals; and whereas church-builders might be conservative and sentimental, castle-builders perform aimed at pure construction.

The course of the development of castle-building is contemporary, and affords an interesting parallel to church-building. The most advanced school was seated in Normandy. Choisy says that the most ancient western fortresses, which show Byzantine influence, are found in Normandy and England—Falaise, Loches, Rochester. At the end of the twelfth century the castles of Richard Cœur-de-Lion are contrived on the most learned combinations, and Château Gaillard marks an epoch in military architecture. It belongs to the system of defence elaborated in Syrian castles during the twelfth century, when Syria, from whence Richard brought the principles, became the classic land of fortification. In the course of the thirteenth century the Ile de France became the *foyer* of castle-building, as Coucy evidences.

In Palestine the castles of Toron and Scandalion were built as early as 1107 and 1116. The great invincible

stronghold of Kerak, fifty miles east of Jerusalem, was founded as early as 1121, and Iblin in 1142. The names of some of these strongholds give proof of the consciously romantic spirit of the twelfth-century castle-builders. We find Blanchgarde, Nigraguarda, Beauvoir, Belfort, and Mirabel. Henry II.'s castle near Tours also bore this last name, and in the same spirit of the Arthurian romances Richard Cœur-de-Lion called his stronghold at Les Andeleys Château Gaillard.

The most recent and careful French writers, now that they find that cross-ribbed vaults were so early in use in England, are no longer as ready to be bound to the ogival vault as the only origin of Gothic. Enlart writes: "The ogive is so little the only characteristic that there exist ogival buildings without ogives." But the superiority of French buildings has always been admitted by a section of English writers ever since G. D. Whittingham wrote a truly remarkable account of French architecture exactly a hundred years ago, undertaken to prove "the superior advances of the French in Gothic architecture." It is true, however, that his remark that the exterior of Notre Dame, Reims, is the most beautiful piece of architecture in the world, was objected to by John Carter in the *Gentleman's Magazine*, with a burst of patriotic archæology, as a "ridiculous, malignant, and unwarrantable Bedlamite tirade."

It is the flying buttress which is the most characteristic member of perfected Gothic architecture, and this feature does seem to have been developed by the school of North France and Paris. In this region the transitional style was carried forward in so rapid a movement, and with

such a fire of enthusiasm, that it reached a greater height than anywhere else. So great, indeed, is the variation, that the High Gothic of this region forms a species apart. This school borrowed the rib-vault, but the flying buttress it gave. The early phase of the full Gothic may be described as *counter-arched ogival*. When, by means of flying buttresses, the abutments were fixed, the wall-field was left for the window to spread over. When the bays were entirely opened out by windows, *complete ogival* was reached.

Probably the lead of the North French school may be carried back a step farther, and it may have resulted from accepting and systematically applying the pointed arch in association with ribbed vaults. The origin of Gothic architecture may be fairly held to date from this conjunction, and this first form might be called *pointed ogival*. The ribbed vault itself is found so early, in work so typically Romanesque, that it must be held to be the completion of that style rather than the origin of the Gothic. But *transitional ogival* might date from its introduction. The churches of Morienval and Tracy-le-Val are good examples of the Northern French transitional style. (Plates 28-29.)

Into Germany and Spain the thirteenth-century art of France seems to have been definitely imported, and as far afield as Sweden and Hungary we hear of French masters being called to execute works. Renan has put in evidence how a master of Paris was in the thirteenth century (1263-1278) commissioned to build the church at Wimpfen, near Heidelberg, "in opere Francigeno." The style, he says, was then called *Opus Francigenum*, and that is the name it ought to keep.*

* "Lit. Hist. France," ii. pp. 210, 255.



TRACY LE VAL CHURCH, c. 1130



Gothic art is that art which, following step by step the development of the Middle Ages, blossomed in the thirteenth century and closed its first period with the Black Death. We may most simply set for it an arbitrary period which will be fairly correct by taking the Great Plague (1348-1350) as its centre; and by setting two hundred years on either side of this we get 1150 as the beginning and 1550 as the end of Gothic art.

Gothic architecture, to which I must particularly refer in these pages, is a sort of fairy story in stone; the folk had fallen in love with building, and loved that their goldsmiths' work, and ivories, their seals, and even the pierced patterns of their shoes should be like little buildings, little tabernacles, little "Paul's windows." Some of their tombs and shrines must have been conceived as little fairy buildings; they would have liked little angels to hop about them all alive and blow fairy trumpets. In the building of the great cathedrals it must be allowed that there is an element that we do not understand. The old builders worked wonder into them; they had the ability which children have to call up enchantment. In these high vaults, and glistening windows, and peering figures, there was magic even to their makers.

I would, if I could, say something to increase our reverence for this architecture as something not to be entirely understood. We cannot by taking thought be Egyptian or Japanese, nor can we again be Romanesque or Gothic, and when we consider the century of critical inquiry which has been devoted to this art, and the artists of the same century enthusiastic in subjecting the monuments to the process called "restoration," it might be

well to inquire if any of us have ever yet seen a Gothic building? As a spectacle, yes; but, as the builders understood it, no. As I have already said, attempts are continually being made to sum up Gothic architecture in a formula, as the architecture of pointed arches, of ogival vaulting, of subdivision and subordination, and so on; but, as we find it in fact, it was the product of given historical circumstances, as well as of the special principle of Gothicness, whatever that may have been.

As general characteristics, we may say that Gothic architecture was developed by free and energetic experiment; it was organic, daring, reasonable, and gay. The measure of life is the measure of Gothic.

The most penetrating criticism of Gothic architecture that has been made is that of Prosper Mérimée, who pointed out that a great cathedral like Amiens is a highly strung organism with its most vital parts, the flying buttresses and window mullions, exposed to the weather. Such a cathedral is more like an engine than a monument, in that it is only kept in order by unceasing attention.

The great cathedrals seem to have been built on such a scale that they might almost gather the entire adult population of the city within their walls. As to these marvellous buildings, the half of their glories and wonder cannot be told. They are more than buildings, more than art, something intangible was built into them with their stones and burnt into their glass. The work of a man, a man may understand; but these are the work of ages, of nations. All is a consistent development, stone is balanced on stone, vault springs from vault, interlacing

tracery sustains brilliantly dyed glass as branches hold sun-saturated foliage, towers stand firm as cliffs, spires are flung into the air like fountains. In these buildings all may be explained as devised for ritual use and for the instruction of the people; all as material and structural necessity; all as traditional development; all as free beauty and romance in stone. From whichever point of view we may approach them, the great cathedrals satisfy us, and their seeming perfections are but parts of a larger perfection. Nothing is marked, nothing is clever, nothing is individual nor thrust forward as artistic; they are serene, masterly, non-personal, like works of nature—indeed they are such, natural manifestations of the minds of men working under the impulse of a noble idea.

In such a church the arcades of the interior, which sustain the vaults, circle around the altar and abut against the western towers. By means of vigorous ribs of stone which spring from the pillars and spread over the internal area, a light web is suspended, so that the great space is covered by a tent of stone, one of the most wonderful of man's inventions. The push of these ribs, collected at certain points, is met by the exterior abutting arches called "flying buttresses," which, acting as props, carry the weight to the ground, and thus counterpoise the thrusts of the interior. The interspaces between the several points from which the vaults spring are practically relieved from work, and here the windows were put. As, generation after generation, the masons worked away in perfecting their scheme of construction, every part of the fabric was gathered up into a tense stone skeleton. This resulted in, or was itself occasioned by, another ideal which aimed at

turning the whole inactive wall-space into windows, so that the cathedral became a vast lantern of tracery ; then, by picturing the spaces by means of transparent jewels of glass, the interior was lighted by angels and saints innumerable. In the porches and screens were placed hundreds of statues, all parts of a connected scheme, an encyclopædia of Nature, History, and Theology.

We must remember, too, that these Gothic buildings were not few and unrelated ; cathedral towers rose over strong town walls, and crowded, many-gabled houses, while outwards the country was so closely set over with fair abbeys and villages that the voice of the bells was heard from church to church as they called to one another throughout the whole of Christendom. Moreover, the ritual had been perfected by the daily practice of a thousand years, and was linked to a music that belonged to it as the blast of trumpets belongs to war. All were parts of a marvellous drama, the ceremonial life of a people.

If we seek for causes for the formation of Gothic art out of its immediate antecedent, we shall find the first and chief in the general historical facts of the period. In such a time of growth and consolidation a corresponding change in the arts must follow. The transition in architecture coincides with great changes in the constitution of town communities and the status of the workman. Romanesque architecture, outside Italy at least, was monastic and feudal, and the builders were attached to the soil. Gothic on the other hand, is the architecture of towns, guilds, and masters who were free to pass from place to place.

The mutual binding together of groups for a common

purpose belongs in some degree to all societies, and guilds of craftsmen probably continued in existence in Italy, at least, from Roman days. In Constantinople, as we have seen, the guilds were highly organised, and there is some evidence to suggest that the mediæval guild system, which ultimately spread from Italy over France, England, and Germany, derived much from the East. For instance, the order of the *Arti* in Florence, in the thirteenth century, follows very much the model of the corporations of Constantinople in the ninth; and at the same time the guild regulations of Paris were very similar to both. It is a curious fact, moreover, that in the thirteenth century *latomos*, the Byzantine word for mason, was used in France and England. I suppose that workers in the West derived their customs and organisation from groups of Byzantine artists working in Italy; and that it is to the existence of such groups in North Italy that we owe the easy transmission of Lombard architecture over Western Europe, which ultimately led to the establishment of similar guilds and the development of Gothic. When the towns of Northern France became communes, the guilds became regular schools of craftsmanship. A mediæval town was a sort of craft university, and Gothic art is the art of the Masons' guild.

The more direct action of the East upon the West in the age of the Crusaders, which undoubtedly was one of the causes of the upheaval of the soil which made new growth possible, was brought about in many ways—by pilgrimage, by commercial enterprise, and, above all, by the unconscious absorption of new ideas by Western knights who were long in power in the East.

Another leading cause of the change to Gothic must have been the great monastic expansion, associated as that was with St. Bernard's criticism of the older barbaric ornamentation, and the falling back upon the first principles of structure which resulted from it. The monastic reforms, passing in waves over Europe during the twelfth century, led to an enormous volume of building being undertaken in the erection of great establishments for the reformed orders.

The reformed Cluniac Order was established by Odo of Cluny, *c.* 920. In 1076 the Order of Grandmont was instituted. The Augustinian, or regular, canons were greatly spread abroad in the first years of the twelfth century. The Cistercian Order, an offshoot of the Cluniac, was founded in 1092 at Citeaux. Orderic, writing twenty-seven years afterwards, says that in this time the mother-house had given birth to sixty-five abbeys. They were given "such names as God's-house, Clairvaux, Charity, and others like, so as to attract those who heard the names pronounced."* The Carthusian Order was instituted by St. Bruno, born 1040, who, with a few followers, retired (*c.* 1080) to an Alpine pass, and there built their first house, called the Chartreuse, the prototype of all other Charterhouses and Certosas. Savigny, the mother-house of the order of Tiron, was built about 1112. This order was absorbed by the Cistercians in 1148.

Another order was that of the Premonstratentians, founded by Norbert, chaplain to the Emperor, who withdrew to a solitary place near Laon called Prémontré,

* These and other French names, as Cherlieu, Bonport, Valbenoît, &c., may be compared with our own Beaulieu, Vallecruis, &c.

and founded (in 1120) a community under a strict form of the rule of St. Augustine. "So that from the time of the Apostles scarce any one," says Herimann of Tournay, "has done more service to the Church, for although it is not full thirty years since his conversion, we have already heard of about one hundred monasteries built by his followers. Norbert placed a few of his monks to serve the poor little church of St. Martin at Laon, and there are now about five hundred monks in that monastery, and ten other houses have sprung from it."

It is said that the Bishop of Laon, from 1113 to 1150, built ten abbey churches, "one for Benedict, four for Bernard, five for Norbert."

At the same time that there was this great activity in founding abbeys, there was a like energy expended in castle-building, bridge-building, and the buildings necessary to town life. There can be no doubt that the development of castle-building was made by the great war-dukes themselves. The Tower of London had its prototype in the Tower of Rouen, and it is probable that the Conqueror schemed its defences in detail. It is not to be doubted that Château Gaillard was planned by Richard I. Our Henry III., it appears from the Rolls accounts, was a veritable æsthetic-maniac, only happy when he was engaged in building operations. Sufficient evidence makes it clear that interest in building and other forms of art was universal in the Middle Ages. In many places we find amateur carvings done by prisoners of rank, as at the Tower and Guildford Castle, and these show the same characteristics as other examples of contemporary art. Indeed, it seems impossible to find a scratching on a wall

older than the eighteenth century that does not show feeling for arrangement and beauty.

Such facts as these may partly explain the great outburst of the building art, which we call Gothic.

When, in the first half of the twelfth century, the building art of the Ile de France began its triumphant development, it gathered up the traditions of many schools. The chief influences at that time acting on the native Romanesque were—Byzantine, acting through the South of France; Lombardic and Rhenish Romanesque, acting from the East and North; and Norman from the West. To the Byzantine influence is probably due the introduction of the pointed arch. A distinct German influence is to be traced in Tournay, Noyon, Cambrai, Laon and Soissons. Noyon Cathedral, begun soon after 1131, is one of the first churches which may properly be called Gothic. From the time of St. Medard, Noyon and Tournay had been held conjointly by the same bishops, but in 1145 Tournay had its individual See restored. Tournay Cathedral is a magnificent Romanesque church having apse-ended transepts and a group of four towers surrounding the crossing. Now the Tournay type of transepts was followed in the building of Noyon, but here they are without ambulatories. Cambrai Cathedral (1148–90), however, had circular-ended transepts with arcades exactly like an eastern apse, and at Soissons there remains a beautiful arcaded apse-ended transept (c. 1180). The early forms of Cambrai and Soissons were soon altered by partial re-building. The Cathedral of Valenciennes, however, preserved its original design until the whole church

was destroyed a century ago: "The transept of Valenciennes" was one of the most famous architectural monuments of the North-west of France; it was built *c.* 1160-80 (Fig. 62). As at Tournay and Cambrai there was a

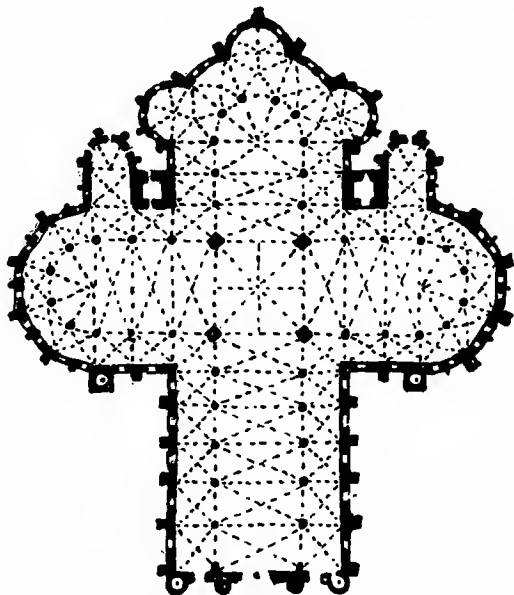

FIG. 62. Plan of destroyed church of Valenciennes with apsed transepts.

lantern tower over the crossing. There cannot be a doubt of the ultimate Byzantine origin of the whole group through Cologne and Tournay. The use of circular-ended transepts continued in the North of France until the beginning of the thirteenth century, when was built the remarkable Cistercian abbey of Chaalis, with radiating chapels opening from the apsidal transepts. (*See* Fig. 63.)

At Laon, although the transepts themselves are square-ended, they are flanked by four high transeptal towers recalling the Tournay arrangement, and from the eastern pair of towers open two circular-ended chapels of excep-

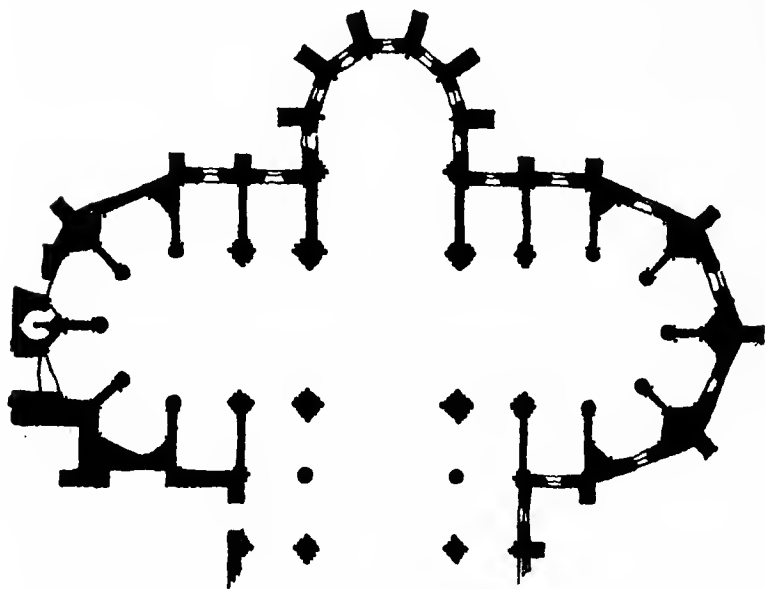

FIG. 63. Plan of church of Cistercian abbey of Chaalis, near Senlis.

tional height and importance, which almost seem like a modification of the apsidal transepts of Tournay.*

Another sign of German influence appears in the four-gabled towers in the neighbourhood of Soissons. The

* The little early church of St. Wandrille near Caudebec has rounded transepts, and the transitional church at Meung is a simpler version of Cambrai. Altogether this is a very important class.

central tower of Braisne follows this type, as also did that of the abbey church of Notre Dame, Soissons (Fig. 64).

The alternation of the piers of the nave arcade, whereby coupled bays were formed, may also be traced to Lombardic and German sources, whether derived directly or through Normandy. The most recent inquirers, like Anthyme St. Paul, Dehio and Von Bezold, and Enlart, are disposed to assign a large share in the transitional movement to Normandy, and Mr. Bilson has shown how Norman work in England provides most important links in the chain of development. To Norman builders we owe the adoption or invention of the ogival or cross-ribbed vault. Dehio says that on the threshold of the twelfth century the Norman school was the first to attain the goal which had been the aim of all the schools of North France. And Enlart rather grudgingly writes: "The ogival vault was in use in the Ile de France and Picardy about 1120. If the most ancient examples are not found here, it is probably in the Norman schools that we should search for them. It seems that in England such vaults were constructed from 1120, and perhaps earlier." In a foot-note the evidence as to the Durham vaults is admitted but without bringing out its full weight, which shows that ogival vaults were built here from 1093 to 1096. (Enlart's Manual, p. 440, and see above, p. 132.) At Laon, Norman influence is to be seen in the arcades across the ends of the transepts, a treatment found at St. Stephen's, Caen, and at Winchester. At St. Germer (c. 1140) and Poissy (c. 1140) Norman influence may also be traced. The vaulted triforium gallery which we find at Noyon, Laon, Paris, and elsewhere was also a Norman feature, but not exclusively so.

The development of Gothic in the North of France

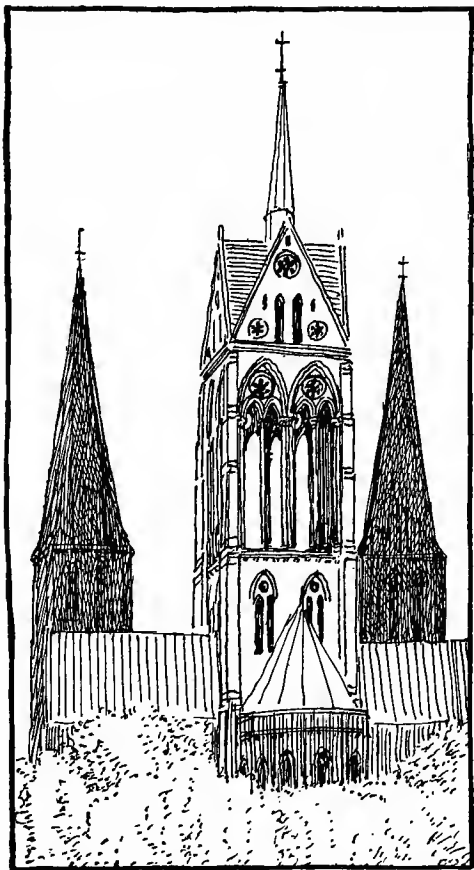

FIG. 64. Destroyed abbey church of St. Mary, Soissons.

probably followed trade-routes along the river valleys of the Seine, Oise, Marne and Aisne. The country churches

of this district even more than the cathedrals show the intense building energy that was put forth during the twelfth century. About Soissons, Laon, Senlis and Beauvais beautiful churches are to be found at every mile or two. There must have been great prosperity in all this region when such works were produced.

One of the noteworthy facts of the growth of Gothic was the rapidity of its advance. Fast as rumour the seed ideas flew, and a harvest of churches, great and small, sprang up over a vast field.

compartment is crossed by two diagonal ribs, and this is called "quadripartite vaulting."

The high vaults of the French churches, built in the last half of the twelfth century, usually had six cells to a compartment; that is, an additional transverse rib was put at the intersection of the diagonal ribs, and the cells of the vault were modified accordingly. This form probably

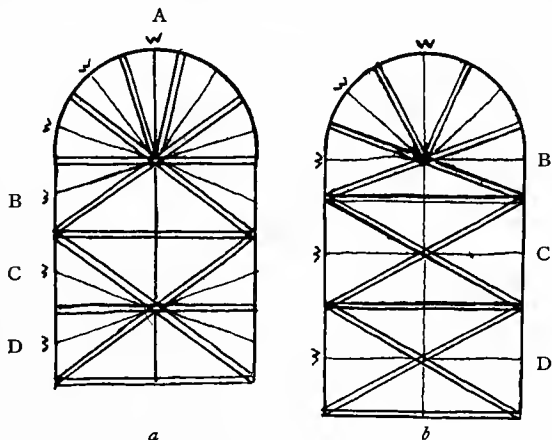

FIG. 65. Diagrams of vaults.

originated in the adding of a strengthening arch to a quadripartite vault. When, in the latter half of the thirteenth century, the aisle vaults of Beauvais were strengthened, they were changed into quasi six-celled vaults. In some early vaults there are arches of a similar kind, and although existing examples do not seem to be earlier, or so early, as some true six-celled vaults, it is likely that such approximation to them did once exist. There were several reasons which led the builders to accept

this form, but it was probably retained chiefly for the following one : in Fig. 65, *a*, A is an apse with its vaulting ribs ; in the next bay, B, the diagonal ribs were not thrown right across, but butted against the point where the apse ribs converged, so as to form a resistance to their thrust. Bay B is thus vaulted in three cells, and if we now treat bays C and D in exactly the same way (alternating the direction of the diagonals), we get the arrangement in the figure, where C and D together make up a six-celled vault. W W are the windows. It will be seen that this system makes coupled bays which are approximately square. Moreover with such vaults every coupled bay nearly repeats the width of the great bays opening to the transepts. By means of making the great transverse ribs into arches more substantial than the rest of the ribs and accentuating the vaulting shafts below them into an echo of the main piers of the crossing, it was possible to interweave an arched order rising the whole height of the walls with the lesser order of the nave arcade. Several examples show that this was aimed at. In Lyons Cathedral the larger alternate piers of the arcade are all like the four piers of the crossing.

The bays around the apse are always comparatively narrow, and this opened up the way to another method of spacing, which later became the normal one, and is shown on the right, Fig. 65, *b*. Bay B has now become one of the apsidal bays, and about half the width of the ordinary bays C and D, which are each vaulted in four cells.

In English vaults, from about 1260, intermediate ribs are often found to the four-celled vault, thus subdividing each triangular web of the filling, as shown in D, Fig. 66.

This naturally resulted in the systematic use of ridge ribs, as shown in the figure. Some writers have said that this addition of ribs is a fault of principle; but that cannot be admitted, although there may have been lack of boldness.*

The essential principle of the Gothic vault is the placing of ribs where the surfaces change their directions, that is, at the diagonal intersections. Thus the transverse rib found in all Gothic vaults is itself but an *intermediate*, and in narrow spaces a surplusage. It helps, however, to support the vault web, and in wider spaces justifies itself. English builders preferred still further support, and it cannot be thought that French masters of the best period would have hesitated to use the expedient on principle. Indeed, the great vault over the crossing of Amiens, which belongs to the first building of this part, allows us to say that the master, in this case, did feel the need of additional support, and obtained it exactly as it is done in an English vault of the same time. Will the critics adverse

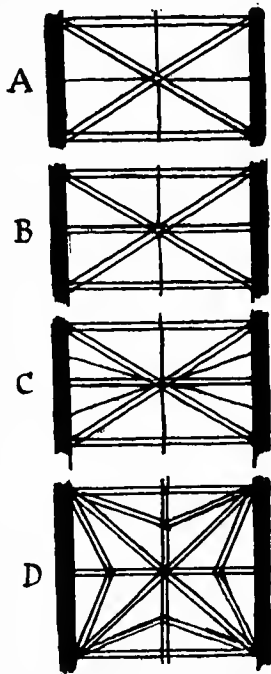

FIG. 66. Diagrams of vaults.

* Professor Moore says, "The three ribs, transverse, diagonal, and longitudinal, are the only *constructive* ribs of any vault"; others he calls superfluous, "ribs which have no necessary function"

to English Gothic say that the Amiens master adopted an English invention? In Fig. 66, A shows a bay of a quadripartite vault. B shows the same with an additional transverse arch, which turns it into a pseudo-six-celled vault. C is a true sexipartite vault as explained above.

The pointed arch was used by Byzantine builders, and its use spread over the East. In the West it is found in the eleventh century. One of several reasons for its adoption must have been that such arches could be constructed with less elaborate centring than circular arches. Doubtless many were built on little more than two timbers inclined at an \wedge angle. Compare what has been said above on page 36 as to the elliptical brick arches of Egypt.

Early French masters in their use of the pointed arch generally confined themselves to those whose curvature varied within a narrow range, and they appear to have standardised three or four varieties, between the semi-circular and equilateral arches. When a relatively high space had to be occupied by an arch they usually stilted it, that is, raised the actual springing level above the capitals down to which the arch mouldings were continued vertically. Standard arches were called three-point, four-point, five-point, and so on; terms which were already in use at the time of Villars de Honnecourt. If the span of an arch is divided into three, four, five, &c., the centres of the curves of the several arches are in each case placed on the two points farthest from the springings of the arch. The three-point arch is relatively low, the four-point arch is steeper, and the five- and six-point arches still more nearly approach the equilateral form.

In a square vaulted compartment, if the diagonal ribs are made, as they most frequently were, semicircular, they would rise higher than transverse arches of the three-point form, and the vault would be slightly domical; this was the earlier form of vault.

Four-point transverse arches rise just exactly to the same height as semicircular diagonals, and give level ridges; this was the later form of vault.

It may be that these forms of arches were preferred for some such reasons; but in any case, working with arches the geometrical relations of which were known, simplified the conduct of works without elaborate drawings, and the sketch-book of Villars de Honnecourt shows how much building recipes of this sort were valued.

More than the vaults themselves, the French way of staying them with flying buttresses was characteristic of the progress of Gothic. The first flying buttresses were simple quadrant arches, like those around the apse of the St. Germain des Prés, Paris, consecrated 1163. They reached an extraordinary development at Chartres and Reims, and above all at Beauvais. They seem to have been in general use from about 1160, at Ourscamp, Laon, &c. But in England there was a long period after their introduction by the Sens master at Canterbury before they were generally adopted, and they were haltingly used until Westminster Abbey was built, after 1245. The buttresses of this church closely follow French models.

It is possible that this hesitation may have come from a dislike of their essential weakness as being exposed to rapid decay; but, notwithstanding this weakness, great Gothic

construction depends on the bold use of the "butting arch." This reluctance delayed the general use of high vaults,

so that the middle spans of noble churches like Byland Abbey and Ripon Cathedral were not vaulted. Others, like Rivaulx (choir) and St. Hugh's choir at Lincoln, were vaulted, but without external support. In both these cases flying buttresses were added later. Even in the middle of the thirteenth century, when Salisbury nave was built, the supports were all kept under the aisle roofs.

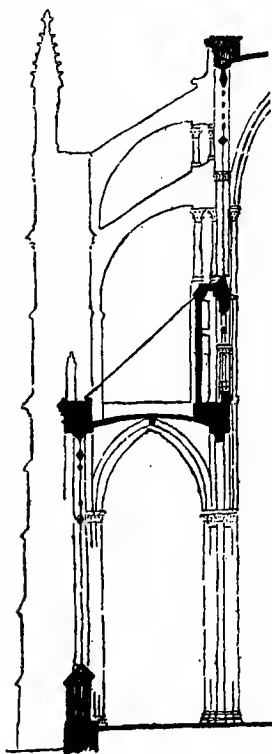

FIG. 67. Sketch section of one side of nave, Amiens Cathedral.

Buttresses had begun as pilasters of slight projection, and became strong piers rising above the aisle roof from which the flying props were thrown to support the clerestory, then pinnacles were added to increase their weight and resistance to lateral pressure. They increased until they seemed like pierced walls standing at right angles to the main building. Finally, channels were wrought in the upper side of their sloping backs, down which ran the water from the main roof, which was then thrown clear of the building by far-projecting gargoyles. At the same time the original walls

between them disappeared in arched openings filled with glass. (Plate 30).

In churches like Amiens Cathedral or St. Urbain at Troyes, there is hardly any wall left; and in these buildings a tendency is to be remarked to substitute thin double screens of stone for thicker work. The construction tended to become cellular (see the triforium and clerestory of Amiens, Fig. 67). Building thus with double screens connected by piers is, for rigidity and lightness, the last word in construction of masonry. Brunelleschi made use of a similar principle in the double shell of his dome at Florence.

It should be pointed out that French building admitted of the extensive use of ironwork ties and chainage. The windows were subdivided by strong grates of wrought-iron, some of the horizontal bars of which ran on through the piers continuously. At the Sainte Chapelle a chain was imbedded in the walls right round the building, and the stone vaulting-ribs were reinforced by curved bands of iron placed on each side and bolted to them.

In the plans of French churches we find a largeness and unity of conception to which the English churches afford little parallel, and it must be remembered that the general disposition of areas and masses is the first of constructive problems.

One of the most remarkable churches I have ever seen is St. Frambourg at Senlis. This is without arcades, a simple "vessel," with an apse rounded like a poop. It is 150 feet long and 32 feet wide, vaulted in four great sexpartite bays, and one half-bay next the apse. A single

row of lancet windows high up in the vault, and one great

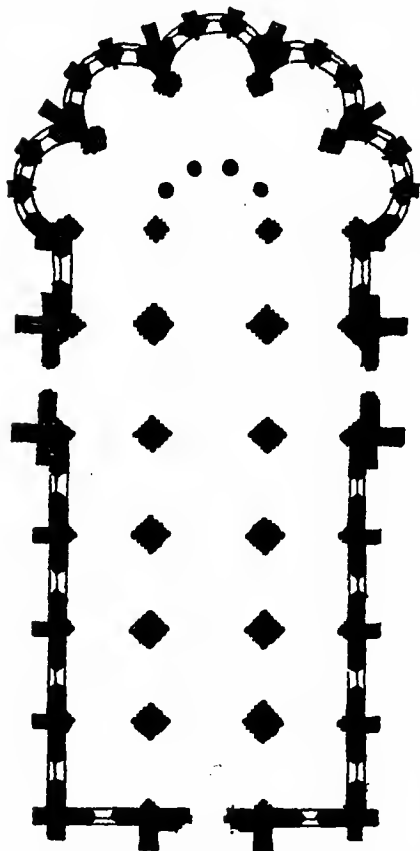

FIG. 68. Plan of church at Chars, Oise.

circle in the west gable, admit the light. Outside are sturdy buttresses and a plain, steep, tiled roof.

Mantes Cathedral (c. 1200) is similarly expressive of one idea. Here there is an arcade which continues from the west front around the apse and back again. The aisle runs around in the same unbroken way, without any projecting chapels. At the west end two strong towers stop the thrusts of the arcade. The exterior has a steep tiled roof with red, black, green, and yellow tiles arranged on it in a great diaper.

At St. Leu d'Esserent, again, we find a similar plan; but two towers stand in the position of transepts over bays of the aisles.

Bourges is the greatest church of this class. Here there are double aisles and double arcades circling around the altar and continued to the west end, where they are blocked by towers.

Another great type of French plan is formed by the transeptal churches.

In some of these, as, for instance, Notre Dame, Paris, in its original form, the transepts hardly appear on the plan, but stand in a line with the aisle walls and only become marked above. The fine plan of Chars, Oise (1160-80), is a good type of this form, and it is interesting in comparison with Notre Dame. This class is

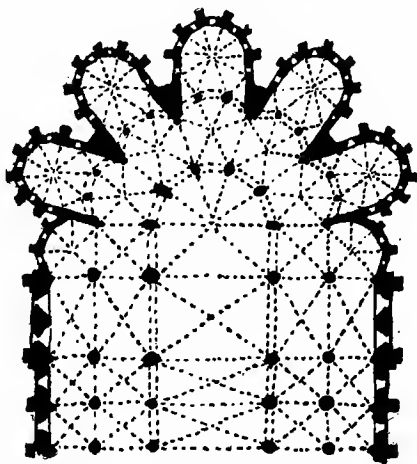

FIG. 69. Plan of east transept and chevet of the church of St. Quentin.

intermediate between the simple vessel and the cruciform type of church. The transepts, if they were arcaded like the nave, sometimes had two towers to each, one at the end of each aisle, as at Laon, Chartres, &c.

At Tournay, Cambrai, Soissons, and Noyon the cathedrals follow another perfect constructive type. Here the transepts were apsidal, like the east ends. These apses resisted the interior pressure like horizontal arches (*see* Fig. 62).

The office of towers, in the economy of these great buildings, was to furnish large buttressing masses. For the purpose of stopping the arcades at the west end, one great tower sometimes took the place of two side ones, as at St. Quentin and St. Germain des Prés, Paris. At Tournay there are four towers in the re-entering angles of the transepts which take the pressure at the crossing. And pairs of towers are often built in the re-entering angles east or west of the transepts, as at Notre Dame at Châlons, St. Martin at Laon, &c.

In the rearing of apsidal chevets set around with chapels the French masters were occupied with a great problem that we in England hardly touched. Not only have we the results to prove this, but in the Study-book of Villars de Honnecourt we have positive evidence that this, to his mind, was the very centre of his art.

The germ of this system may be traced back through the Romanesque age to Roman architecture. Buttressing a wall in this way by a series of convex chambers is a perfect constructive expedient. When applied to the circular head of a church, forming so many chapels, the whole seems more like natural crystallisation than mere planning. For a full account of the development of apses it is necessary to consult the pages of Viollet le Duc. One remarkable apsidal termination, however, which he does not notice, is that of St. Quentin (*c.* 1235). This, it seems probable, may be the work of Villars de Honnecourt himself; it certainly is the contrivance of a man who had seen much and tried to combine many excellences. Not only the chapels, but the arcades opening into them, are in this case bowed. The vaulting of the ambulatory is carried

higher than the chapels to allow room for low clerestory windows. The apse is thus surrounded by a double tier of convex chambers, as is plainly seen from the outside.

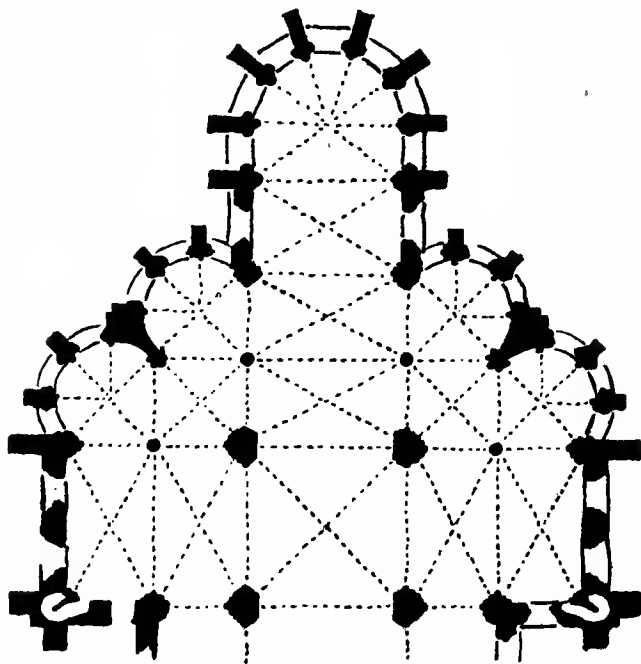

FIG. 70. Church of St. Yved at Braisne, near Soissons.

In this church the apse starts from a narrow secondary or eastern transept (Fig. 69). The exteriors of the huge apsidal chevets * of Beauvais, Bourges, and Le Mans are just as marvellous as the interiors, the great sweeping walls of

* Chevet means head, and is applied in France equally to square endings,

windows being set around with a very scaffolding of pinnacled buttresses and ramping arches. (Plate 30.) The most perfect of all the schemes of planning apsidal chapels is that followed at Toledo by a French master; it has been well described by Street.

The conventual church of Braisne, close to Soissons, follows an interesting type of plan, which, while approximating to the usual arrangement of apsidal chapels, derives rather from the three parallel apses (Fig. 70).

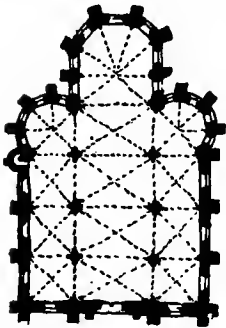

FIG. 71. Church of Ville-neuve-le-Vicomte.

At Mons, near Laon, the church, a noble one built about 1180-1190, has three such apses. At Villeneuve-le-Vicomte is a still simpler instance of the same type, there being in this case no transepts (Fig. 71). The destroyed abbey church of Vaucelles, of which the plan was taken by V. de Honne-

court, is an extremely beautiful solution formed, it seems, by combining the apsidal form and the plan of Braisne together (Fig. 72). Some echo of the same idea may be seen in the plan of St. Quentin (Fig. 69).

In England, desiring chapels, but not the French means of obtaining them, we hit on a compromise, as in the nine altars of Fountains and Durham. The general use of the second transept in England came about in the same way. Both gave room for chapels, but did not require the great science necessary for the erection of apsidal chevets.

At the end of the twelfth century the circular type of plan was used in the chapel of Liget near Loches, built

by our Henry II., *c.* 1176. The Temple churches belong to a similar class. Fig. 73 is the plan of the chapel of the Templars at Laon built *c.* 1134.

Gothic buildings, as they have come down to us, have been subject to many additions, changes, and chances;

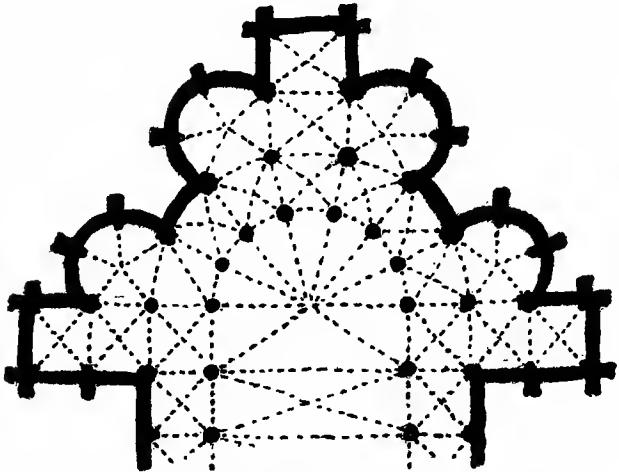

FIG. 72. Destroyed abbey church of Vaucelles, near Cambrai.

moreover, hardly any one was built throughout in a time sufficiently short to give it absolute homogeneity. On comparing a number of examples, however, it becomes clear that they were schemed on large lines to satisfy given purposes with materials readily obtainable. The builders valued spaciousness and height, lastingness, and fair workmanship, but ideas of a picturesque conglomeration of parts, or of abstract proportion, probably never occurred to them. If we turn from the cathedrals to the little

village churches we find that they were in the first case built as directly for their purpose as a cart or a boat would be.

A large majority of the most famous churches have been “designed” to make use, in a greater or less degree, of old foundations. Chartres Cathedral is founded on a pre-existing crypt, and is terminated by an old west front. Westminster Abbey is largely built over old foundations, and when rebuilt by Henry III. in 1245, had to fit in between a Norman nave and a lady chapel built in 1220, as well as to connect properly with the old cloister. Angers Cathedral is famous for being vaulted in one great span of “fine proportions”; recent excavations have shown that the walls belong to an anterior building which

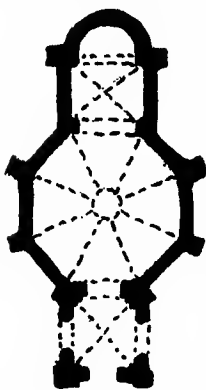

FIG. 73. The Templars' Chapel, Laon.

had arcades, but these were cleared away. In Fig. 74, A A shows the eleventh-century church, B B the church as rebuilt from the middle of the twelfth century. Under such circumstances there is little opportunity for planning abstract proportions.

The regular course of works in rebuilding a church was to build in sections from the east end. While the choir was being built, the nave remained in use; when it was finished and dedicated, the nave was undertaken; that finished in turn, chapels were added, or the choir was lengthened eastward, or they began to build all over again, once more at the east end. One of the most interesting

examples of transformation known to me is at Wetzlar, on the Lahn. The choir having been rebuilt in the fourteenth century, while the nave remained Romanesque, a new west front was begun a bay in advance of the old one; but the new work was never finished, and the noble Romanesque front still stands behind the elaborate screen of the unfinished new façade.

It is vain to look, as many have done, for any general doctrines of proportion in work so conducted. Moreover, in the relation of voids to supports, and heights to substance, Gothic "proportion" was governed by a law of its own. The principle was exactly that of natural growth.

Structure was always tending to overpass the limits of stability. In the narrow field left for choice there may have been a preference for planning leading dimensions on

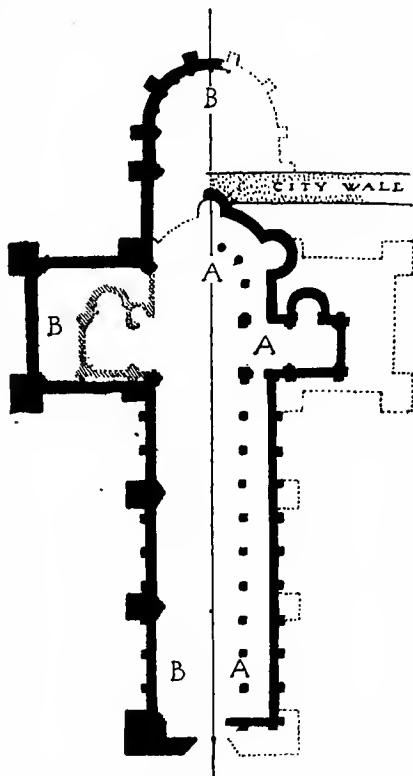

FIG. 74. Plan of Angers Cathedral, showing how the final form B was conditioned by the earlier plan A.

a series of squares or triangles, and the recurrence of similar relations echoing one another is likely to produce some harmony in all arts.

In the studies of V. de Honnecourt attempts are made to

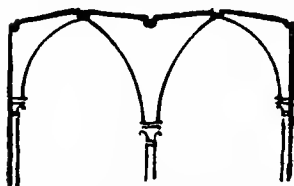

FIG. 75. Section of the great hall of the abbey of St. Martin des Champs, Paris.

triangulate the proportions of human figures and animals, and Dürer was interested in similar problems. However this may be, whether for structural reasons or otherwise modifications in normal geometrical setting out were readily made. Thus, in

the magnificent double-aisled hall of St. Martin des Champs, Paris, the curves of the vaulting are set out as in the figure.

The popular view of Gothic is that it is the architecture of traceried windows; and, indeed, the principle of construction involved in branching over wide spaces with stone bars is as important as any in the Gothic code, and it made possible the final conception of making the walls a structure of posts and bars filled by screens of stained glass. Single lancet windows had grown to be of great size, seven or eight feet wide at times, and, as in the apse of Chartres, forty feet high. They were very strongly barred with iron. Subdivision by slender bars of stone naturally followed, and the association of circular lights above coupled lancets opened the way to tracery.

Traceried windows proper, of two lights with cusped circles above, seem first to have been used in the apsidal chapels of Reims, begun in 1211.

The evolution of traceried windows, as followed by Prof. Willis, at first seems to be a perfect demonstration. From an early time sub-arches are found under a containing arch, and piercings, growing bigger and more complex, were made in the shield of stone between the sub-arches and the containing arch. This, indeed, seems to be a true account for triforium arcades (compare Noyon and Amiens), but, as a matter of historic fact, the origin of traceried windows in the great French school of ogival art depended on the association of a rose window with lancets beneath. This at first may seem a small distinction, but it will be found to explain several survivals in early French windows. The clerestory windows of Chartres will best make this clear, and in this case there can be no doubt of origin. In each bay two lancets and a big rose are brought together into one composition under a containing arch which is less a relieving arch over the windows than part of the general pier and arch construction. (*See V. le D.*, vol. v. p. 381.) In the parallel design of Laon cloisters the containing arch is absent altogether. In the apse windows of Auxerre (Fig. 76), this bringing together of a rose and two lancets

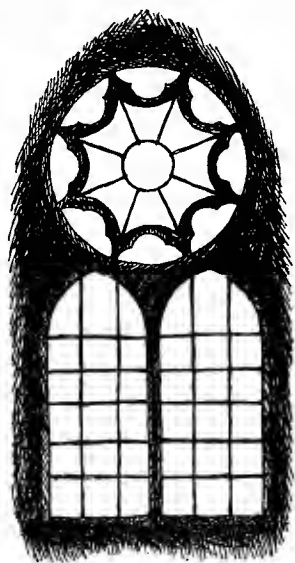

FIG. 76. Apse windows of Auxerre Cathedral.

is still perfectly obvious. At Bourges we find a similar treatment in the narrow bays of the apse and in the wider bays of the choir roses are set over *three* lancets. At Lyons three little roses are piled above three lancets, but all are still separate.

In Fig. 77, from the hospital of the Abbey of Ours-

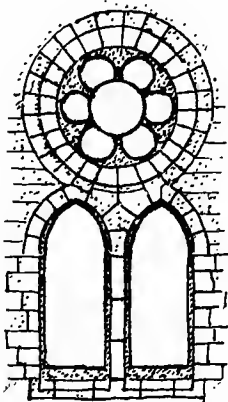

FIG. 77. Rose and two lancets from Ourscamp, c. 1190.

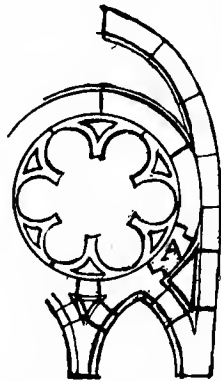

FIG. 78. From V. de Honne-court's sketch of the construction of early traceried windows at Reims Cathedral, c. 1212.

camp (c. 1190), the rose and lancets have hardly yet become one window, but in the combined arches we find the certain germ of the tracery bar.

Now let us turn to the famous windows of Reims. Here the containing arch is that of the bay. The rose combines with the two lancets as in the last instance, but not with the containing arch. In roses, as in Fig. 77, the piercings are made in a slab, or slabs, set in the circle. It is the same in the circles at Reims (Fig. 78).

Very curiously, when cusps were introduced, at a little later time, into the heads of lancets they were inserted in separate thin pieces, and this treatment was a survival from the cusped slabs of roses.

In this view of their origin the form of highly stilted French windows, as in the example from Reims, finds a complete explanation and justification. They are rose-headed couplets.*

In the similar windows at Amiens the rose obtains additional support by means of two strong crockets which push against it (Fig. 79). This again speaks of the original idea. Villars de Honnecourt's sketch of the Reims windows makes it clear that such support was necessary for the lower part of the rose, for he shows it as constructed with joggle joints as in A, Fig. 78.

In the nave clerestory of Amiens, begun in 1220, the principle of subdivision is carried a step farther, and we get large four-light windows of bar-tracery all cusped in the circles. Windows such as these were used in the Chapter-house at Westminster, begun in 1245. At Chartres we find little lancets pierced in the spandrels on either side at the bottom of the transept roses. This is carried a step farther at Chalons Cathedral (Fig. 80), and at last the rose and the



FIG. 79. Construction of early traceried windows, *c.* 1220, Amiens Cathedral.

* See the west window of St. Nicaise, V. le D., vol. viii. p. 60, and the four-light windows at St. Denis, vol. v. p. 394.

lancets were merged into one glorious traceried window like the north window of Amiens.

Perfected windows, with the tracery filling the arched

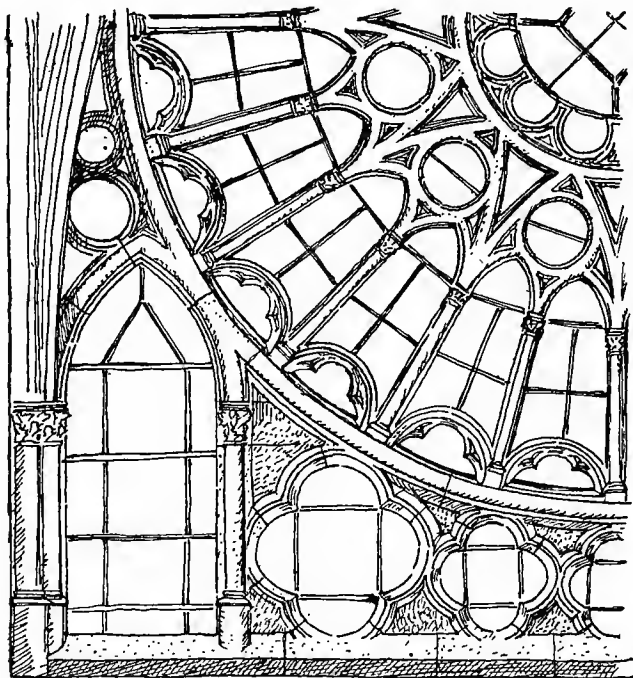

FIG. 80. From the rose window in the north transept of Châlons Cathedral.

head and the upright lights cusped, are perhaps first found at the Sainte Chapelle, Paris, 1240-8. After the windows had spread over the whole bay up to the arched vaulting rib as seen from within, a further development was made in the middle of the thirteenth century by

making them fill up the square-headed bays of the exterior, thus being bounded only by the buttresses and the main cornice. In this case the heads of the windows are pushed up into "pockets" left in the thickness of the

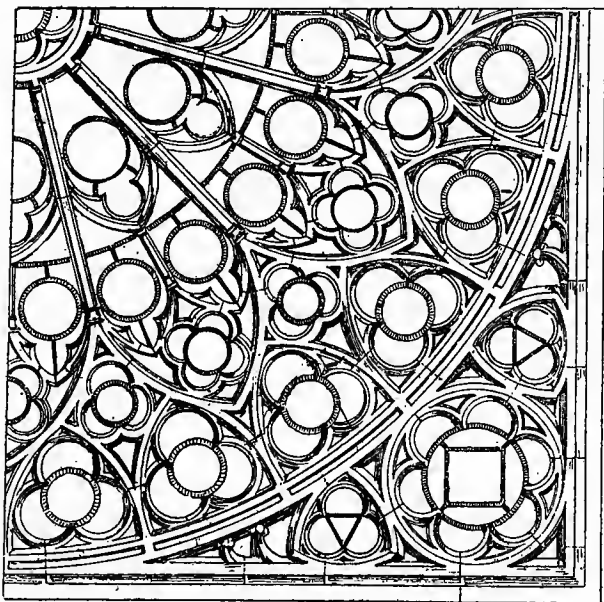

FIG. 81. One quarter of rose window, Notre Dame, Paris.

wall behind the vaulting ribs. Viollet le Duc gives instances of this treatment, and Fig. 82 is a parallel treatment from the triforium windows of Amiens (*c.* 1250-1260). The open arcade crowning the west front of Notre Dame, Paris, is another beautiful example of similar method. The square spandrils of rose windows were also

opened out and combined with the circles. Fig. 81 is a quarter of one of the transeptal Roses of Notre Dame.

On consideration of the many surpassing excellences to be found in Gothic windows, both in their stone frames and the glass which fills them—the essential and high

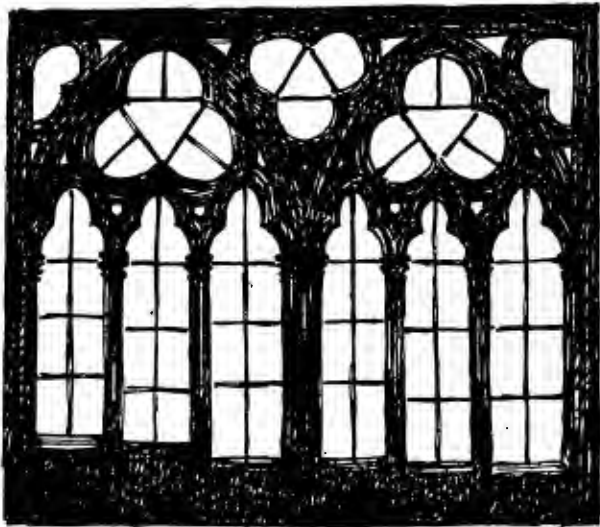

FIG. 82. Triforium windows from the transept of Amiens Cathedral.

part that they serve in the economy of the building, the scale, frequently upwards of a thousand square feet, whereby the figured glass may be seen by a concourse of people, and, above all, the way in which such a window lends itself to, and becomes a part of, the glory of light—I am forced to say that the window of dyed glass is the most perfect art-form known. So any one must feel who



W. R. L. del.

BOURGES CATHEDRAL. GLASS. CHRIST OF THE APOCALYPSE

Face p. 176

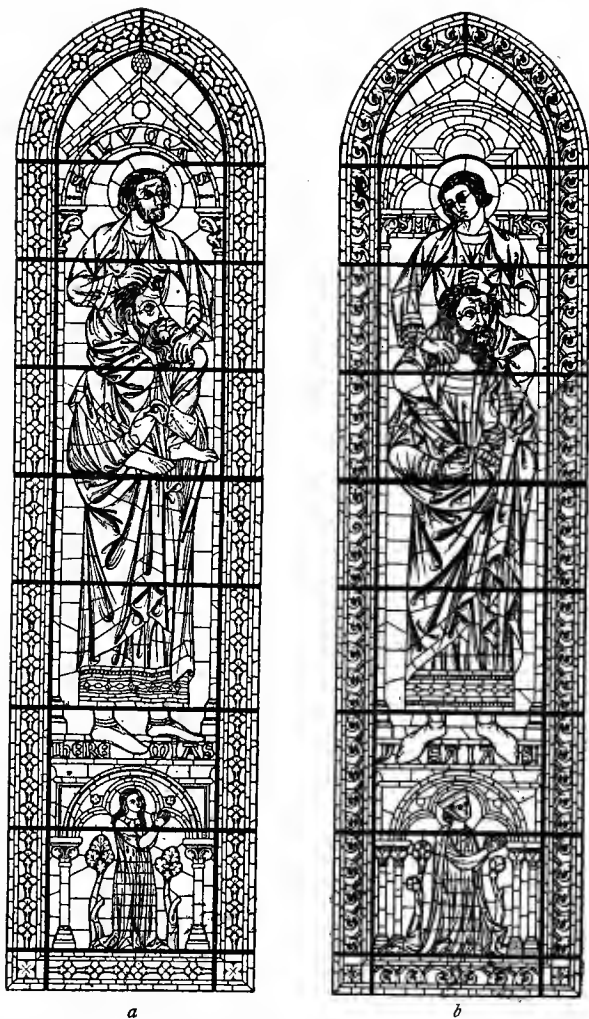

FIG. 83, *a*, *b*. Stained glass from south transept of Chartres Cathedral (after Lassus).



FIG. 84a. Chartres, upper part of window called Notre Dame de la Belle-Verrière.

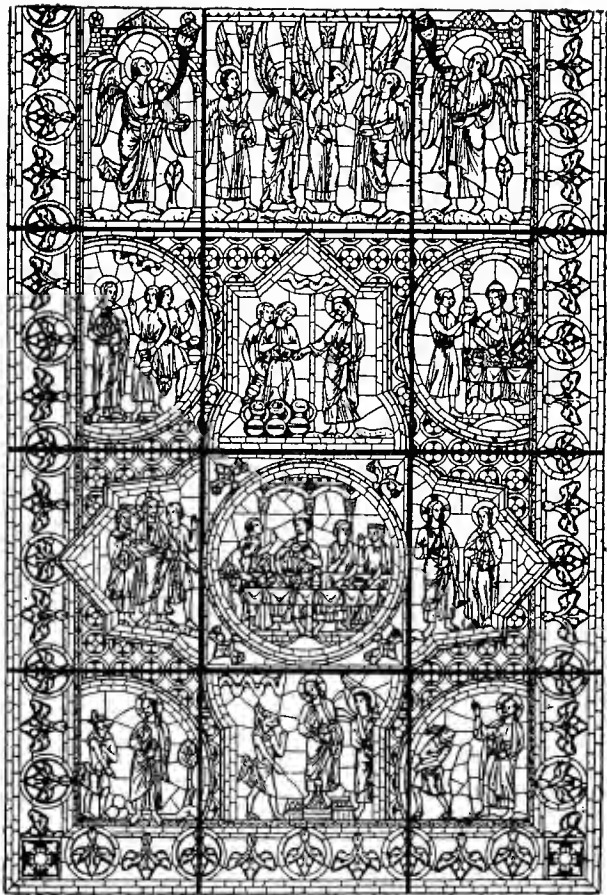

FIG. 84*b*. Lower part of same window at Chartres
(after Lassus).

has watched the changing hues of the windows of Chartres, Bourges, or Reims, through a summer's afternoon, from the hour when the shadows of the flying buttresses fall in great bands across the burning glass, to the twilight when they fade and hardly glimmer in the gloom of the vaults. (Plate 31.)

Such windows were not depicted merely in transparent colours, as we are apt to think ; but from the thickness, texture, and quality of the old glass it holds the sunlight, as it were, within it, so that the whole becomes a mosaic of coloured fire. Up to the middle of the thirteenth century the usual colour scheme was of crimson and azure, cleared by small fragments of white, yellow and green. The "pitch" of the colour is the intensest conceivable, and stimulates the sensibilities like an exultant anthem. One feels that this dazzling mixture of blue and ruby was made use of by a deeper instinct than taste. Such windows seem to fulfil an active part in cathedral ritual—an incense of colour.

The windows of St. Louis' chapel, of which some large portions are now in the South Kensington Museum, were celebrated in the saying: "Wine the colour of the windows in the Sainte Chapelle."

Figures 83 *a, b*, and 84 *a, b*, are outlines of windows at Chartres. In the former, with daring symbolism, are the Evangelists mounted on the shoulders of the Prophets. Below are little figures of donors. The other window called *La Belle Verrière* has the Virgin and Child surrounded by adoring angels, and beneath stories from the life of Christ. In both the Virgin and the Prophets there is an obvious strain of Byzantinism. In Fig. 85 from



W. R. L. del.

CHARTRES CATHEDRAL, GLASS. FIGURE OF DONOR,
GUY DE MONTFORT

Face p. 180

Laon may be observed the same tradition. Figures of donors appear on many of the lights of Chartres; in the circles of the clerestory are mounted knights, amongst which is Guy de Montfort. (Plate 32.) In the south transept



FIG. 85. Portion of window from Laon.

are the Lord and Lady of Dreux and all the little Dreux. Other windows given by Guilds show pictures of daily business, a butcher killing cattle, a blacksmith shoeing a horse, carpenters, masons, a fur and mantle shop, and so on. Stained glass was well developed in France in the twelfth century. Theophilus tells us that at that time French glass was the most famous.

Spire construction, again, also seems necessary to the full Gothic idea. Spires are in reality steep stone roofs. The scale of building became too vast to apply this method of covering to the chief spans, but we can see in such an example as Loches the germ of a constructive possibility never, it may be, fully explored. At St. Nicholas, Caen, again the apse is covered with a stone-built roof, and smaller apsidal chapels here, at Norrey, and at Bourges Cathedral are covered in a similar way. Spire-building had reached an extraordinary development in France during the twelfth century, but in England it was rather timidly handled until the end of the thirteenth century.

Stone-slab roofs were frequently used, especially in the south. The vast cathedral of Toledo seems to have been covered with ingeniously designed stone roofs of low pitch as were also other Spanish cathedrals. The outer aisle roofs of Notre Dame, Paris, are covered with large slabs resting on arches. The magnificent pavements of engraved stone slabs may also here be mentioned. Those of St. Omer and of St. Nicaise, Reims (now at St. Remi), are the best known.

A fine characteristic of first French Gothic is found in the use of monolithic columns, which often have the classic entasis. At Vézelay the shafts themselves bear mouldings of slight projection close to the base, like their antique prototypes. The free use of the monolithic column must be included among the expedients of all the highest architectures. The capitals and bases of such cylindrical columns are usually very noble.

The eastern limbs of the cathedrals were enclosed

between the pillars by high stone screens forming choirs. The finest existing enclosures are those of Paris and Amiens. At the west end of the choir was the *pulpitum* or *jubé*, a double stone screen carrying a loft, on which stood the nave rood, the choir organs, and a great lectern. The lower stage was an arcade, in the centre of which was the choir door, and right and left nave altars. The forms of the *jubés* of Paris, Chartres, Strasbourg, and Amiens are known from sketches taken before their destruction, and several of the lovely sculptured panels which adorned the front of those at Chartres and Bourges still exist. (Plate 33.) In the choir the high altar usually stood on the chord of the apse, and behind it, between the two central eastward columns, was the retro-altar, or altar of relics. A painting preserved at Arras is the best authority for the original form and furnishings of such altars. Six slender columns of bronze or silver stood, three on each side of the high altar, carrying rods to which were suspended curtains, and bearing figures of angels who held the instruments of the Passion. Above and behind the altar was a silver reredos, or "table," as it was called. The early silver reredos and the altar of St. Denis are exquisitely delineated in a painting of Jean Van Eyck.

At Amiens, behind the altar, was a second double stone screen like another *pulpitum* with little winding stairs to mount to a platform, on which were exposed the precious shrines and other relics of the church. At the Sainte Chapelle there was a somewhat similar arrangement of great beauty, more like a baldachin, and with open spiral stairs. Above the high altar at Bourges was the "ciel," or tester, above which again rose the choir rood, with images

of St. Mary and St. John all painted and gilded. From the tester hung the tabernacle of the sacrament. On the left of the altar was a watching chamber from whence priests guarded the altar and its treasure through the night.

At Arras a large tabernacle for the relics was supported between the two eastern pillars and directly above the relic altar, so as to be seen beyond and over the high altar. In front of the high altar at Bourges stood a tall, seven-branched candlestick. Across the choir ran a beam supporting lights, and to it was suspended the Lenten Veil, which divided the presbytery from the choir, on either side of which were the stalls for the clergy, and in the midst the eagle lectern. On feast days fine tapestries were hung in the arches above the stalls.

The bishop's throne, which earlier, in basilican arrangements, stood at the back of the apse, was later placed at the side of the altar.

It is difficult to get a clear idea as to the typical form of west fronts, hardly one of which is complete or homogeneous. St. Denis, Senlis, Notre Dame at Châlons, and Chartres best represent the transitional forms; and of these the Châlons church, with its two western leaded spires and rose-window, is the most complete; while the scheme of Chartres must have been the most stately and furthest advanced of its age (Fig. 91). Laon, Paris, and Mantes are a linked group built, or begun, about 1200. Of these Laon was the earliest, and set the type. A rough view printed before the destruction of the stone spire which, before 1793, surmounted the south-west tower (it is doubtful whether its companion was ever completed),

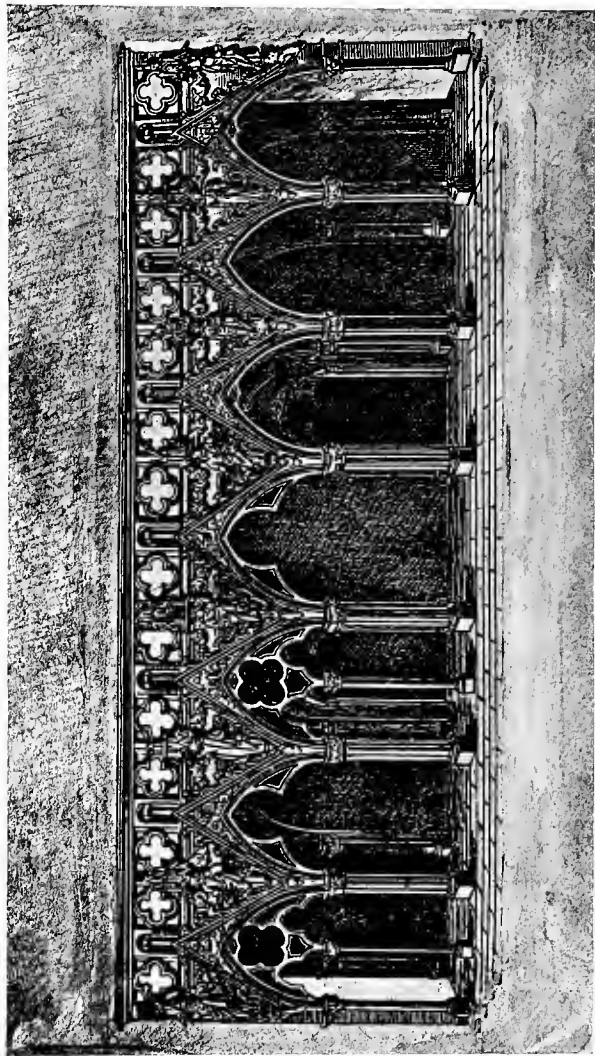

STRASBOURG CATHEDRAL. THE PULPITUM, NOW DESTROYED

allows us to gain some impression of what was aimed at in all these façades. When complete it would have risen nearly three squares high. The lowest square is occupied by the sculptured doors with the rose and two lateral windows above; the next tier by a gallery over the rose, and two towers pierced through and through with tall openings, while the acute crocketed spires rising from these towers would form the third stage.

Holy Trinity, Caen, possesses one of the completest of west fronts, but the lower part is plain Norman, and the towers are of transition work; only the spires, which are magnificent, are fully Gothic. Contances, also in Normandy, has a remarkable west front. The portal front of Notre Dame, Paris, is the classic example of work balanced in its enthusiasm and power; here strong horizontal bands are more marked than in any other example; but we must remember that the towers were certainly intended to bear high spires as at Laon, which would have greatly modified this effect.

In most of these fronts, as also at Reims, spoken of in another place, the peak of the gable is masked between the two towers by a horizontal arcaded gallery. At Rouen, Reims, and elsewhere the contrivance by which, through having immense openings pierced in them, the towers were designed not to block the light in the church, resulted in extraordinarily open construction. At Laon the pinnacles and staircases are open cages of pillars, and the whole tower is seen against the sky like the silhouette of a traceried tabernacle.

Of façades a little later in date the ruins of St. Jean des Vignes, Soissons, is a fine example.

Early French Gothic building is characterised by simplicity, directness, and clearness. The details are larger than corresponding work in England. Arches, shafts, and capitals are not, as a rule, channelled into a multiplicity of mouldings. It was felt that beyond a certain point "detail" must change its character into carving, and again, beyond a point, that ornamental carving must give way to sculpture. French sculpture of the great period is only to be rivalled by the finest Greek

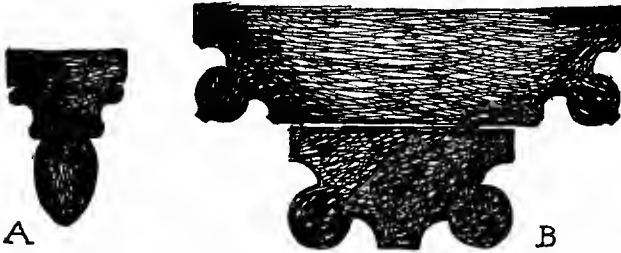

FIG. 86. French Gothic mouldings.

work; and the ornamental carving was bolder, freer, and more varied than ours—directly inspired by Nature, but not servilely imitative.

In the mouldings of French churches of the best period all evidence of the squared courses and orders out of which they are hewn does not disappear; the profiles glorify, but do not disguise, the masonry. In Fig. 86, A is a vaulting rib from Chartres, B is an arch profile from Lyons, both standards of excellence. In Fig. 87 the cutting is excessive, except in the case of the base C from Noyon, which is typical of fine French bases. D is a window jamb, E an arch impost, and F a string moulding, all from Norrey.

The question of moulding is one of the most difficult to explain. Up to a point, moulding has some practical justification, as in the rounding of an edge, but this takes us a very little way. Generally it is a means of bringing

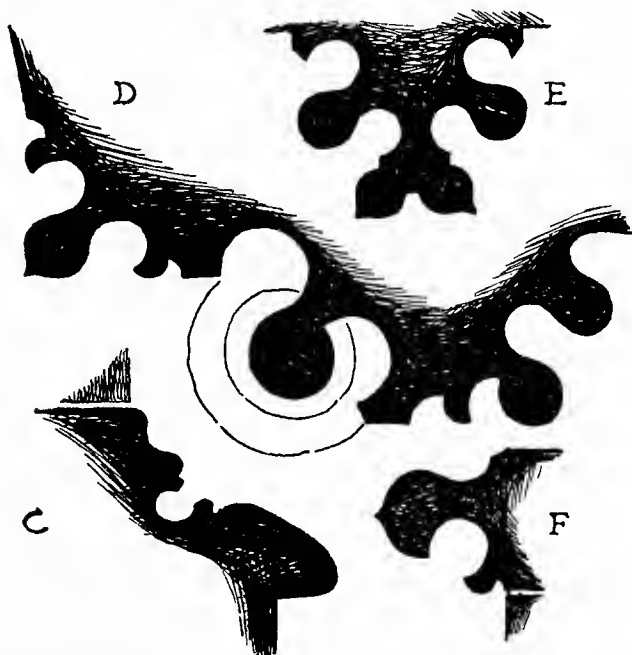

FIG. 87. D, E, F, Gothic mouldings from Normandy. C, Base from Noyon.

delicacy into the scale of a building, and, in the main, moulding is a method of emphasis and of shading in the solid. Here, quick hollows give an expression of force; there, soft rounds form transitions and middle tones.

Alongside of the structural development of Gothic

building into functional members, the general law of concentration and activity went far beyond structural implications into a code of expression to which we usually and disguisingly give the name of "decoration." Of course, "decoration" tended to become the symbol of the pride of a bishop and the wealth of a merchant; but, at the best, it was the vehicle for other ideas than richness. As Gothic construction was energetically pressed forward, arches were sharpened, vaults were made wider, all excess of material was taken from pillars, and window-lights drew together by much the same law that makes the honeycomb an example of bar tracery. But beyond all these due results of the Gothic principle of construction, the builders desired an expression of tense nervous energy, till works like the fronts of Reims, Strasbourg and Abbeville seem electrical, and as if the stone leapt into spray of flame. (Plate 34.)

It is necessary to separate clearly the essential Gothic of structure, the art of thrust and parry, from this over-Gothic of expression; the one dealt with universal laws of building constant for all time, and the other, towards the end, passed into highly specialised forms of local and momentary meaning, and was at times even morbid and hysterical. It is, however, just these special "Gothic" forms, never properly apprehended, as copying them proved, which made the stock-in-trade of those who professed to supply modern Gothic art.

Organic Gothic, let me repeat, must last for ever as a theory of building; phenomenal Gothic, as it in fact existed in the past, was possible only to the moments which produced it.

We can trace the historical development of what I have

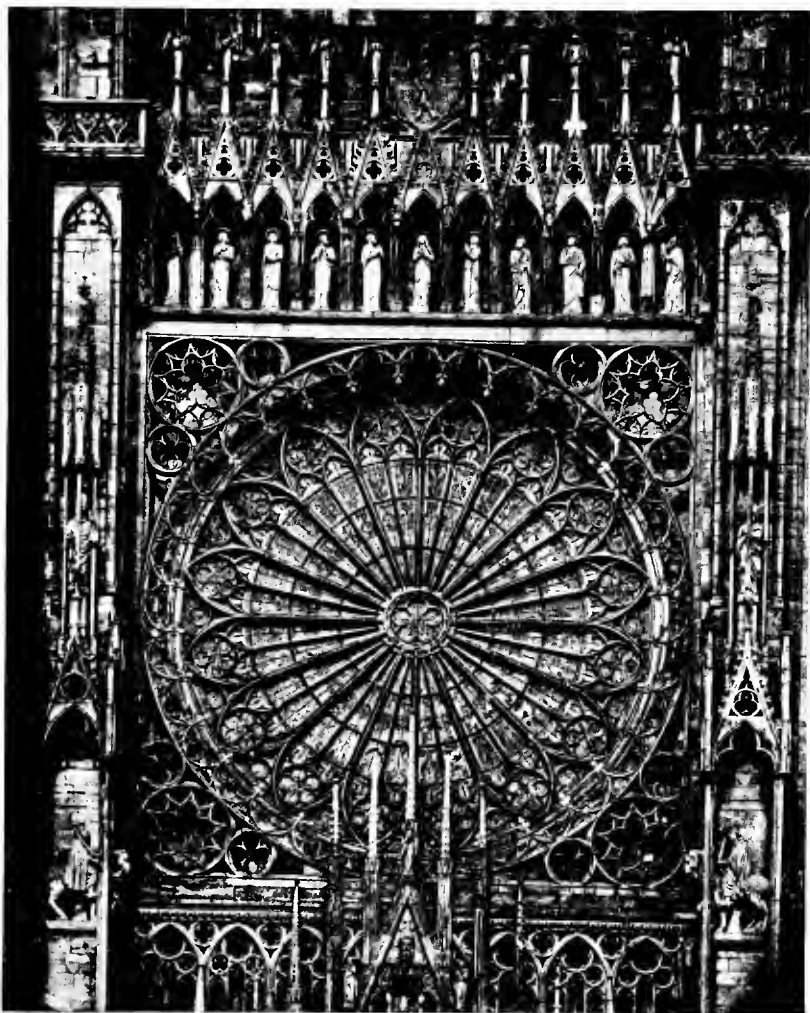

STRASBOURG CATHEDRAL. PART OF WEST FRONT

called over-Gothic, but the question is everywhere obscured at any given time by the inheritance of "decorative features," that is, expression-forms, from the art which went before it.

Arches built in orders had bead mouldings cut into their angles; piers had similar definition given to their edges; pillars were channelled up into many shafts; horizontal courses were hollowed and rounded into mouldings. Then the hollows next the beaded edges of arches were deepened and other beads added till roll-moulding and deep hollows in strong contrast ribbed the whole; the shafted edges of buttresses and pinnacles were connected above with moulded arches to give the shafts something to do; arcades were carved out of wall-surfaces to make the wall itself seem active; from the springing sides of arches grew a strong spur called a "cusp"; spires were set around with little spires—"children," as Villars de Honnecourt calls them; crockets like budding ferns pushed out scrolls along the sloping edges of gables and spires; parapets were pierced, showing the sky set in their foils like azure glass; gargoyles thrust themselves farther out and turned their dragon heads; toy pinnacles were added to the pinnacles, as they themselves were added to the parent spire; gables rose steeper; window tracery ate up more and more of the wall; stone foliage grew in the hollows of the mouldings, statues of saints and angels were made to inhabit every cranny, and the work was illuminated with bright colour and gold.

Such was Gothic art on the crest, and up to this moment every addition had increased the expression of joyous activity; for, at an early time, and within bounds,

the expressive result is most lovely of that which later became a parasitic growth which went far to strangle the style. At the high tide of Gothic there was sufficient intellectual motive, realised or inherited, to give this overlay a justification, were it only that quality of romance which lights up all forms of thirteenth-century effort.

As an instance of inherited custom, it may be said that tabernacle-work as associated with sculpture had a traditional meaning, which can be traced far back into Romanesque art. In miniatures and reliefs, when the action of the figures represented was taking place within a building, it was usual to indicate gables and domes and towers along the top margin, and to carry down pieces of wall or column on the sides. Early examples of architectural canopy-work like those above twelfth-century representations of the Virgin (compare Fig. 84) clearly show this origin. In such situations tabernacle-work is a general expression for the heavenly temple.

In their use of imitation tracery-ornament we can, perhaps, hardly follow or understand mediæval artists. It seems to me that stained-glass windows of the great time—whole rows of them, as we see at Chartres, Bourges, Strasbourg—were, when lit up by the sun into living emerald, ruby and sapphire, so marvellously beautiful, so full of the life of light, that it came about that little figures of windows, used decoratively, were more than mere patterns, they were symbols of windows and of all that windows meant. For instance, there is in South Kensington Museum a romantic silver drinking-cup (c. 1320), whose sides are pierced with tiny traceried

windows which are filled with transparent enamel, so that the wine was lit up with stained-glass windows.

Comparison of French and English art shows that ours was but a provincial variety of the great ogival style, a patois, as Viollet le Duc says of the art of Normandy. English Gothic is not the most typical, and it is a derivative of French art. But, for all that, it is exquisitely beautiful—something more wildling, less self-conscious, and, it may be, even more tender and pathetic. It is so, at least to English eyes, for they must bring to the interpretation of this art some similar faculties to those possessed by the men who built the monuments of our land.

CHAPTER VIII

FRENCH CATHEDRALS

IN the century from about 1150 to 1250, Gothic building in the North of France made extraordinary progress. Absorbing at first what it needed from neighbouring schools, it soon surpassed them all, and the product is on a different plane from the rest, and forms the typical Great Gothic of the cathedrals. St. Etienne at Beauvais, and St. Denis are important links in the transition. St. Etienne (c. 1120) is still somewhat rude, and stands on the Romanesque side of the style boundary. St. Denis, that is such old parts as still remain, is on the Gothic side. It is refined, clear, and energetic. Every artistic possibility was brought to bear on the church, and stained glass, sculpture, bronze, and mosaic adorned the most advanced construction of the time. It was begun in 1137, and in 1143 mass was celebrated at the high altar during a storm, when the ribs of the incomplete vault were seen to sway in the wind.

Noyon and Senlis Cathedrals have much in common with St. Denis. The data in regard to Noyon have lately been re-examined by Lefèvre Pontalis. In 1131 the earlier church was destroyed by fire. The erection of the

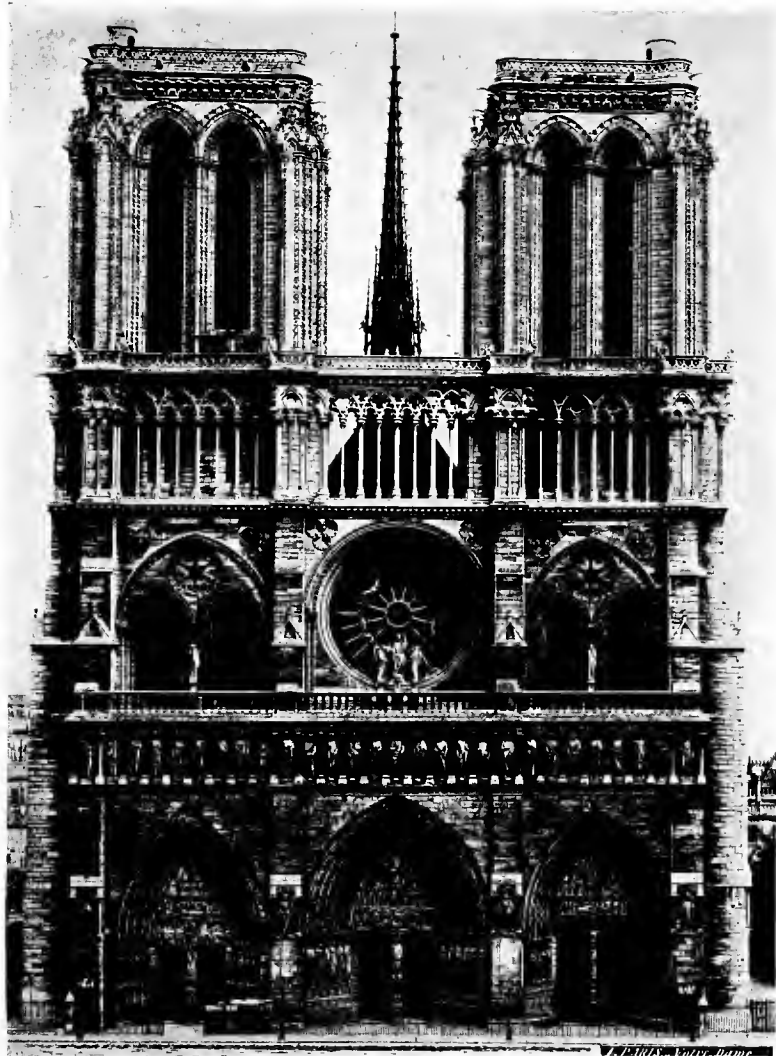

PARIS. CATHEDRAL OF NOTRE DAME, WEST FRONT

choir of the cathedral probably took place between *c.* 1140-57, as in 1157 the Archbishop of Reims translated the relics of Eloi, the local saint, into a new shrine. This part of the cathedral agrees very closely with the apse of St. Germain des Prés, Paris, which is known to have been consecrated in 1163. The treasury and the circular-ended transepts of Noyon were probably completed *c.* 1170, while the nave may be dated *c.* 1190. After a fire in 1293 the vaults of the nave fell in; they were soon afterwards rebuilt with new flying buttresses.

At the east end Noyon is distinctly transitional in type. There are pointed windows in the apse, but in the adjoining wider bays they are circular-headed. The columns around the eastern apse are rather slender monoliths with vigorous capitals. As in several of these transition churches, the triforium is entirely vaulted; such gallery vaults sustained the high vault. The nave triforium has pointed arches with sub-arches and a pierced trefoil in the spandrils. The clerestory has coupled round-headed lights, recessed from the outside under a containing circular arch. The columns of the ground arcade are alternately circular and compound. The main vaulting shafts rise from the ground at the alternate piers, and support transverse arch ribs of considerable size. The other shafts start from the caps of the columns. This seems to show, as Viollet le Duc has observed, that the vault was at first of the six-celled variety. The repetition of the great arches of the crossing obtained by running down the alternate vaulting shafts to the ground is most satisfactory. The aisle circumscribing the apse has circular chapels projecting from it. Behind them, as

seen from outside, rises the circular wall of the triforium with its own range of windows, and behind that again the apse proper. At the west end are two noble towers, and a triple porch forming an open narthex, there are also delightful cloisters and a chapter-house. The porch, built *c.* 1270, has had all its sculpture hacked away, but the vestiges show that this must have been admirable. All that is left is some exquisite foliage and three little panels on the mid-post of the door, types of Christ who stood above—the Phoenix, the Lion, and the Pelican.

In 1155 was begun Notre Dame, Senlis, and this also is of earliest pointed work, severe and strong. At first it was planned as a simple "vessel" without transepts, which were not added till the last days of Gothic. The piers are alternately grouped and cylindrical, the triforium has a large single opening to each bay, the arches are in square orders with beaded angles, the apse is surrounded by chapels. The church was completed in 1184, except the upper part of the west front, and it was dedicated in 1191. The extraordinarily elegant flèche was built about 1240.

Much more important than either of these is the great cathedral of Laon. It had already been in course of erection for some time in 1174, and it was probably begun about 1160. It had long been a puzzle that this church should have a square end to the east; but foundations have been found which show that at first it had an apsidal termination, the chord of which was at the third bay from the crossing. Signs of this are still

perfectly clear in the work. At this point the capitals of the great columns begin to curve, and two other capitals eastward on each side are also curved on plan, showing that they were rebuilt from their former position in an apse which must have had four columns and five bays (Fig. 88).*

The first work seems to have been finished to the west, including the three sculptured portals, by about 1200, and the lengthening of the east end must have been undertaken directly after, as practically the same style is maintained throughout. The arcade of cylindrical pillars with bold capitals about three feet deep, is very fine. There is a vast triforium entirely vaulted, and galleries across the ends of the nave and transepts make a continuous upper storey. The central space is covered with six-celled vaulting, and to the exterior there are fine flying buttresses. Over the crossing is a low lantern-tower, and at the ends of the aisles of nave and transepts rise six singularly beautiful towers which were intended to have high spires of stone. One at least of these spires was in existence when Villars de Honnecourt made his drawing of it—"the most beautiful tower he had ever seen" (Fig. 89). It lasted until the Revolution. Around the base from which these spires sprang are open pinnacles which are inhabited by stone oxen, who push out their heads between the pillars and look down upon the town. These towers open to the galleries across the ends of the interior with tall arches which rise as high as the clerestory; they thus are not mere attachments, but form an integral part of the building. The windows (before later alterations) were wide lancets of nearly equal size, in ground-

* The square extension would give more room about the relic shrine.

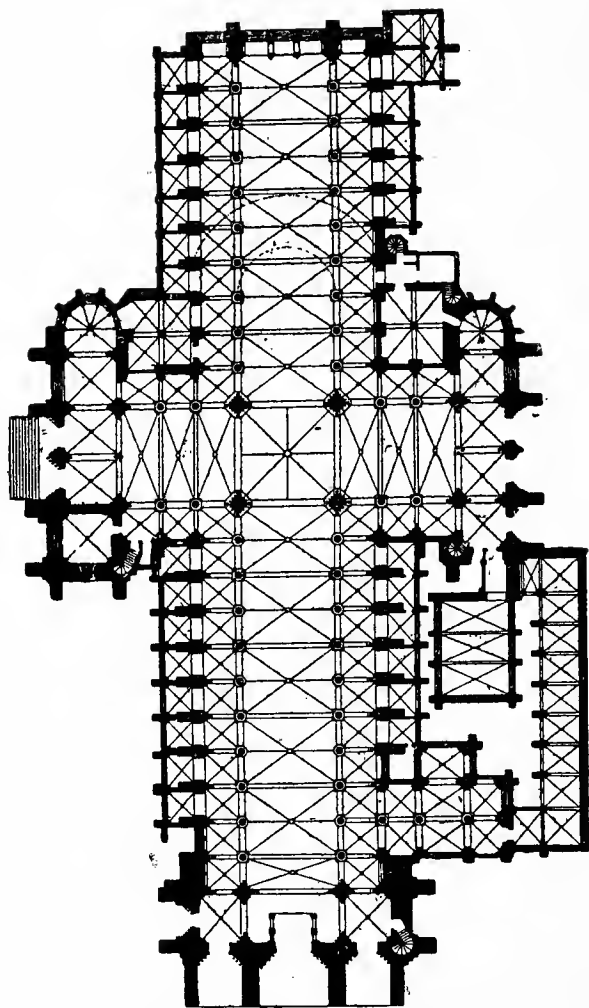

FIG. 88. Ground plan of Laon Cathedral.

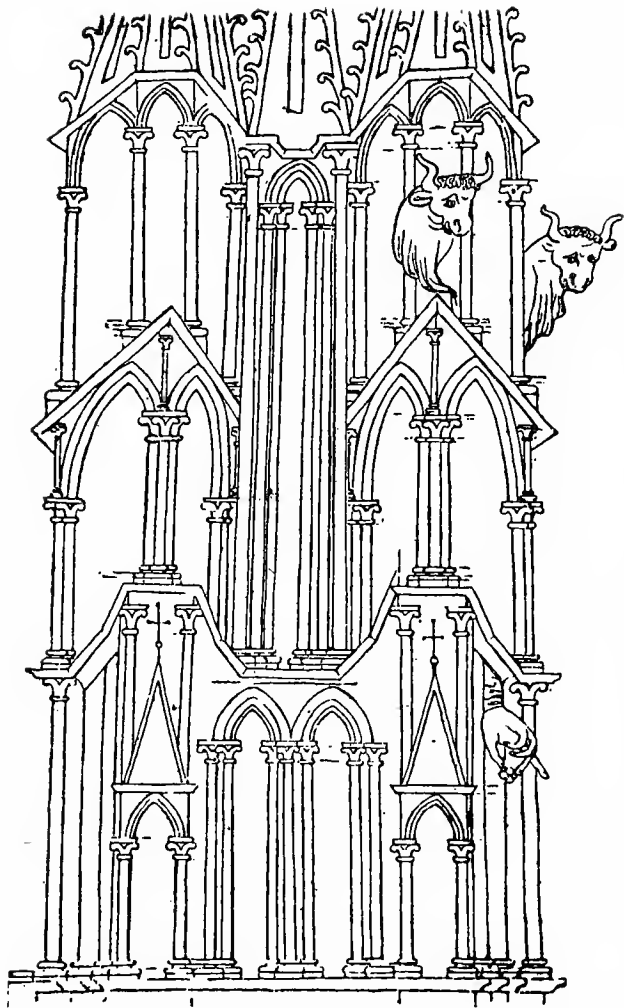

FIG. 89. V. de Honnecourt's sketch of one of the west towers at Laon.

stage, triforium, and clerestory. The four arms of the extended church were lighted by as many great roses, three of which are still filled with splendid glass. The great triple-bayed porch, and the west front generally, has much beautiful old sculpture. This façade of Laon set the type followed at Paris and Mantes of squaring across the top with a gallery. The west front of Reims has a similar termination. At Noyon, between the two towers is seen the preparation for a very tall open gallery, which connected them and heightened the front.

In the original plan of Laon we have a completely organic distribution of parts. The avenues of arcades of the interior are buttressed by the six towers, north, south and west, while to the east they continued around in a semicircle. Over the crossing the lantern-tower gave light and significance to the central point of the church, and almost beneath it stood the high altar.

It was chiefly in regard to Laon that Viollet le Duc propounded his celebrated theory as to the civic use of cathedrals, and the opposition between cathedral and monastic ideals. His view, which he supported by reference to the curious hall-like plan of Laon, necessarily fails in regard to what has now been shown * to have been its earlier form. It has been combated by Quicherat, Anthyme St. Paul, and others, and can no longer be sustained.

Laon is an especially interesting centre of early Gothic monuments ; but a building usually cited as amongst the earliest of transitional works, the chapel in the Bishop's

* V. le Duc in a note to another passage shows that he knew of the earlier form,

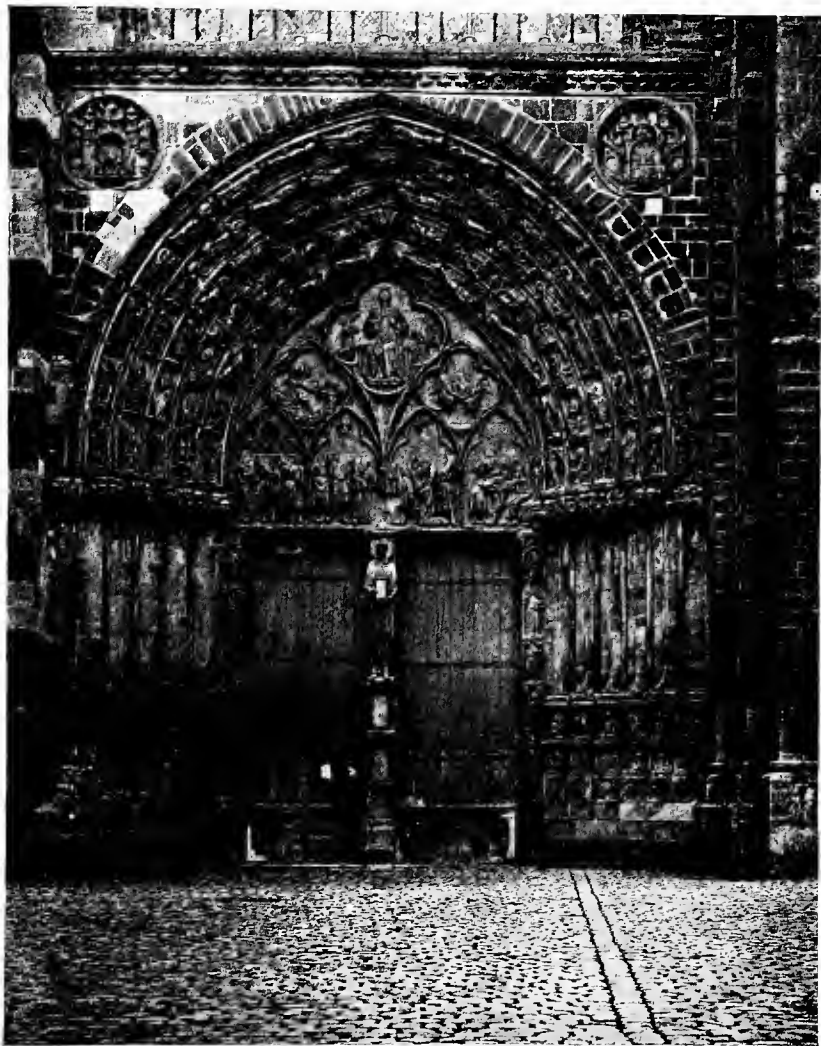

SENS CATHEDRAL. WEST DOOR: LOWER PART, *c.* 1190,
UPPER PART, *c.* 1260

palace, has recently been proved to have been erected after 1155, instead of directly after 1112.

Sens Cathedral was being built in the period 1144-68. Viollet le Duc showed, in his article "Transept," that it was at first built without a crossing, having only two chapels opening from the aisles, the great arcade and vault being continuous from the east to the west. There were no eastern chapels, except probably a central one, as at Canterbury. The high vault is in sexpartite compartments, falling alternately on compound piers and columns coupled transversely. A substantial arch divides off each compound bay of the vault from its neighbours. The triforium is unimportant. The capitals are very noble; although so early, they are finished works, classical of their kind. The church contains some good early glass, and at the west door there are beautiful sculptures. (Plate 36.) Adjoining the church is a magnificent thirteenth-century Synod Hall, now terribly restored.*

There is the closest resemblance between Sens and the work at our own Canterbury, begun in 1174, by a Sens master. Every shopkeeper at Sens knows of the architect of Canterbury.

Notre Dame, Paris, was begun about 1162. In the chronicle of Robert de Monte, under 1177, we read: "For a considerable time Maurice, the Bishop of Paris, has been labouring earnestly and profitably for the building of the church of that city, the head (eastern limb) of which is now finished with the exception of the great roof (*majori tectorio*); if this undertaking be completed there will be

* The building accounts of Sens, as yet unpublished, are preserved in the public library at Auxerre.

none to rival it on our side of the Alps." The high altar was consecrated in 1182 and the church was finished, including the lower half of the west front, about 1225. (Plate 35.)

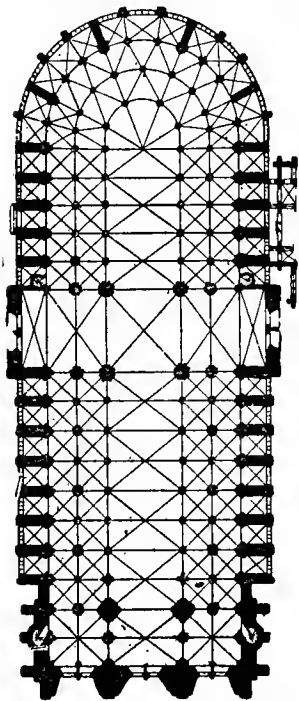

FIG. 90. Plan of Notre Dame, Paris.

As first built the scheme was very large and simple, the apse having double aisles surrounding it, which continued throughout, but no chapels. The rows of great cylindrical columns of the interior arcades form the most perfect of supports and the capitals are severe and fine. The transepts are of slight projection and without aisles. The triforium is vaulted and the second aisle allowed of its having external support, as it in turn supported the central vault.

Notre Dame thus rises in three graduated storeys; each tier was lighted by a row of similar lancets. The high vault is in six-celled compartments, and further supported by bold flying buttresses. At the west end rise two towers, each one standing over the double aisle. Soon after the completion of the church a series of modifications were undertaken at the east end. The clerestory lancets were now subdivided into two lights each, with circles above; radiating chapels were added to the ambula-

tory, and the nave chapels and present transept ends were built. The clerestory windows were glazed with figures of bishops eighteen feet high, which are now entirely destroyed. The rose windows are especially fine, both in the tracery and the glass. Whittingham a century ago says: "The three marigold windows which still retain their painted glass are the most magnificent I have anywhere seen" (see Fig. 81). The original form of plan with transepts in line with the aisles may be compared with Fig. 68. The vaulting of the interior is sexpartite. As the columns and vaulting shafts of the main arcade do not mark this fact, Professor Moore, in accordance with his theory of Gothicness, makes the suggestion that the church was built for four-part vaults, but at the last moment they made the change to the existing form. V. le Duc, however (art. *Ogive*), shows how the whole vaulting scheme follows from the geometrical conditions of the form of the apse and choir, and in another place he shows how the vault system of the nave is marked in the alternating piers of the nave-aisles, as may be seen on our plan. The towers of the west front must have been prepared for spires which were never erected. (See Fig. 91, on which there is a great statue of the Virgin between the towers. And see Appendix.)

Mantes Cathedral is in much a smaller version of Notre Dame. The monolithic columns of the apse with their fine jutting capitals, the vaulted triforium and the roof covered with coloured tiles arranged in a great pattern, are all particularly interesting.

At Soissons in the circular south transept, of which I have already spoken, the three main divisions of the

ground storey are each subdivided into three by slender monolithic columns; the triforium repeats the same arrangement, and it is vaulted like the ground storey. In the clerestory are three lancet windows to each bay. A fine circular chapel opens in a south-eastern direction from the curved transept. The rest of the church was rebuilt about twenty years later than the date of this transept.

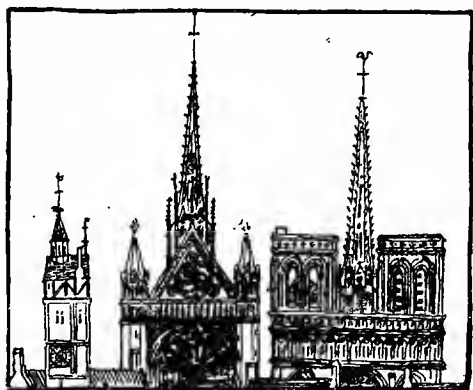

FIG. 91. Notre Dame, Sainte Chapelle, and clock tower of Palace. From Froissart MS. at British Museum.

Here the clerestory windows are coupled and have foiled circles above. The whole church is now terribly restored, but there is a fine porch opening east of the north transept.

Of much the same character as the south transept of Soissons is the fine apse with its radiating chapels of St. Remi, Reims. The earlier church, of Romanesque work, was completely recast in the latter half of the twelfth century, and the width of the central span gives this apse particular distinction. The triforium is vaulted and each bay is lighted with

three lancets; the clerestory has also three lancets to each bay, and all these windows are filled with fine early glass. Each of the radiating chapels, instead of opening by a single arch from the ambulatory, has three arches on slender columns. On the outside there are powerful flying buttresses. The Romanesque Church of Notre Dame, Châlons, was altered about the same time as St. Remi, and it would seem by the same master, so closely do the two choirs resemble each other. The fine west front is of something the same type as Chartres.

Still another cathedral in the same line of descent from St. Remi is Auxerre, begun in 1215. Here only the Lady chapel at the east end of the apse opens to the ambulatory through three arches; there are no other apsidal chapels, but the outer sides of the ambulatory bays are all divided into three sub-bays. The apse is especially noble as seen from without, standing high above the river. The west doors are exquisitely sculptured (c. 1265); the windows have magnificent glass later in character than the Chartres and Bourges windows with their backgrounds of sapphire, here there are deep murrey purples and fair apple greens. The large collegiate church of St. Quentin before mentioned, Fig. 69, stands in this same series.

The beautiful early Gothic choir of Vezelay may also be mentioned here.

The Cathedral of Chartres dates in the main from a rebuilding following a great fire in 1194. The west front, however, is largely of work anterior to that date, and the planning of the rest, including the magnificent chevet, was conditioned by the crypt of the older church. There is a

double ambulatory around the apse, with circular chapels opening from the outer one. The important transepts have aisles, over the ends of which stand towers, two to each transept. By one of the great strokes of French genius, each of these towers, which of course cover the end bays of the clerestory on both sides of the transepts, is pierced with large openings on its three free sides, similar to the clerestory window on its inner side, which is so well lighted by this means, that from within it is not noticeable that the bay is blocked. This treatment is a development upon Laon, and became the standard one for cathedrals of the first rank. At the west end are two great towers with spires, one of which was built before the fire, which it escaped, and it still remains one of the most stately in the world. Two other low towers flank the apse: eight towers in all. The mighty flying buttresses have here attained a high stage of development. The vaulting of the interior is no longer sexpartite but each bay is complete in itself. The clerestory windows are of great size, two wide lancets, with a rose above, filling out the entire bay. Most of the superb stained glass is intact, save for a recent restoration. The special glory of Chartres is, perhaps, to be found in its portals. At the west end are three doors (*c.* 1150-60), and open porches of the thirteenth century spread right across each transept, all of them being crowded with the finest sculptures. Chartres is a work which stands apart between the first and second phases of Gothic, but it derives much from Laon. The placing of the towers is similar, and it was but a step to fill the great open tower arches, like those of Laon, with clerestory windows. The transept porches have their pro-

totypes in the west porches of Laon, where some of the details, like the spirally fluted columns under the statues, and the Jesse tree on the arch, are almost identical. The rose windows in both churches are also clearly related; so is the clerestory at Chartres to the cloister openings at Laon.

A volume might be filled by the several articles which have been written upon the original form of the west front. Excavations, as well as the plain indications on the side walls, show that there was a narthex or porch which occupied the space between the towers, and it is said that there is evidence enough to show that the present finely-sculptured west

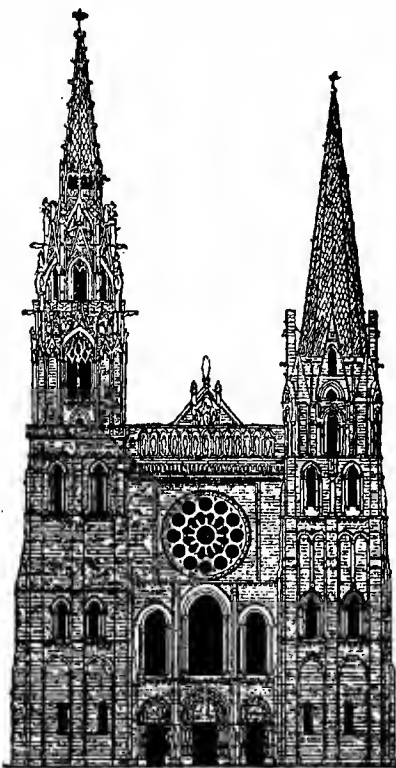
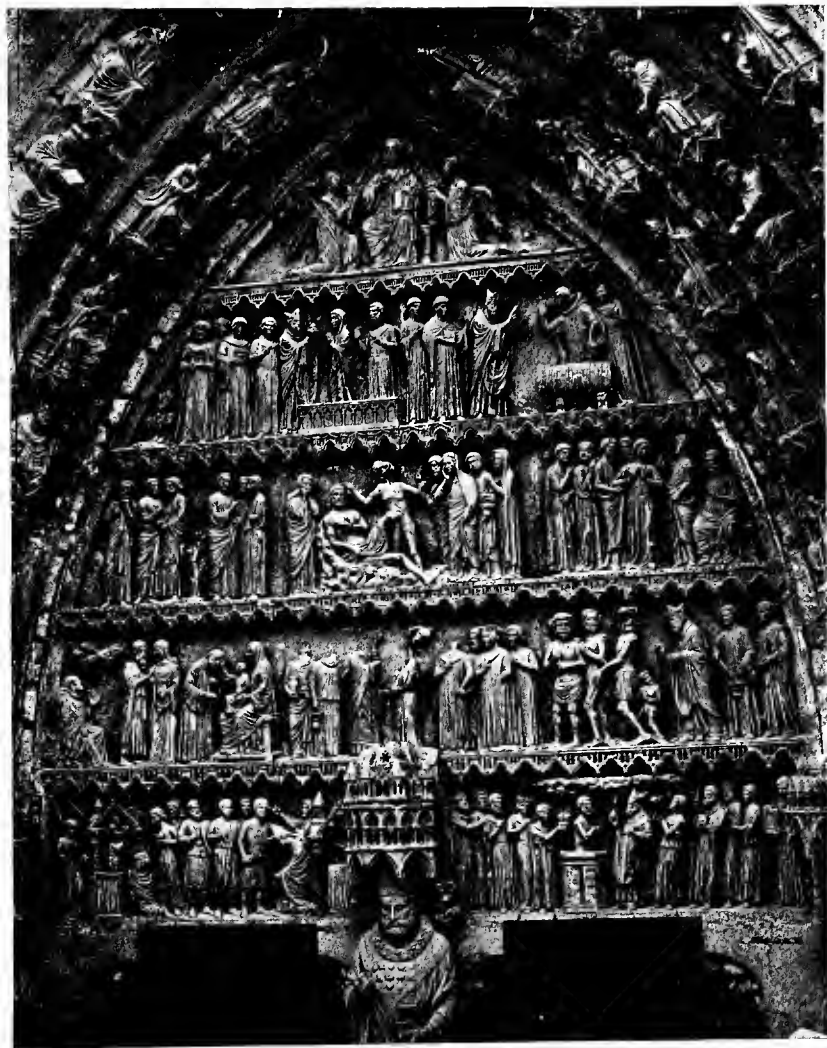

FIG. 92. Chartres Cathedral, west front.

doors were formerly at the back of the porch instead of at the front. These precious doors are in any case one work with the lower part of the south-west

tower. The lower part of the north-west tower had been built still earlier, and in advance of the then existing church, but apparently in preparation for the arrangement which was to follow. After re-examination my own view is that these doorways were built where they now stand together with the windows above them and the S.W. tower. The three wide lancets above the doors must, it seems, belong to mid-twelfth-century work, for in one of them is a wonderful Jesse-tree in stained glass which, as shown by Mr. Westlake, so closely resembles the Jesse-tree placed by Abbot Suger in St. Denis (*c.* 1142) that he believes both are from the same atelier and the work of the same artist. The date of the St. Denis window is certain, for it bears a small "signature" figure of Suger himself. The upper part of the west front, containing the rose window, belongs to the heightened thirteenth-century church. The north-west spire was built in its present form early in the sixteenth century; before that time there was a tall leaded spire erected about 1390.

Reims Cathedral opens the period of perfect maturity. A more ancient church having been burnt, the present structure was begun in 1211, and the choir was occupied in 1241. The nave and the west end soon followed, and the great west porches were built about the middle of the thirteenth century. The west front is a miracle of imagination and workmanship, and the planning and proportions of the interior are of the greatest beauty. The supports, neither too massive nor slender, still stand perfectly upright. The plan is one of the most unaltered left to us, and the crown of radiating chapels became the



REIMS CATHEDRAL. DOOR TO NORTH TRANSEPT, *c.* 1230-40

type for all later efforts. The triforium is but a small wall arcade, and the windows from this time became all in all. At Reims perfected tracery first appears. One pattern of a two-light window with foiled circle above, all in "bar-tracery," having been designed, it was repeated throughout the church, some seventy or eighty times, the same in the aisles and chapels as in the clerestory above (Fig. 78). The lights in the clerestory are very wide and tall, the two lights filling out the whole bay, and each one being eight or nine feet wide. Thirty-one double-light windows fill the clerestory of the central alley, nearly all of which retain thirteenth-century glass of the greatest splendour. It is to be noticed how the plane of the windows is kept towards the inside of the walls here, and in other places where there is fine glass, so that the glass may be seen as well as possible in an oblique view (Fig. 67). At the west end and in both transepts, as in Chartres, there are fine roses, those of the transepts following the Laon type. The columns of the ground storey are formed of central circles with four attached shafts, one of which is continued upward as the main vaulting shaft. The transverse arches of the vault are much bigger than the diagonal ribs, and each compartment is in four cells. There are two large western towers and two others at each transept which follow the Chartres model. There is an elegant *flèche* on the point of the apse roof, and a taller *flèche* once rose over the crossing. It is unnecessary to suppose that this and the transeptal towers were ever intended to be of the exaggerated height suggested by Viollet le Duc; there is, indeed, no preparation beneath for such structures. The finely designed

flying buttresses are weighted by huge open pinnacles, in each of which dwells an angel with wide-spreading wings. There are three sculptured doors at the north transept, besides the western porches, to the sculptures of which we shall return later. (See Plates 37 and 46-49.)

Reims is undoubtedly the prototype of Westminster Abbey, which shows evidence of close study of the French coronation church.

The old cathedral of Amiens was burnt in 1218, and its reconstruction on a vast scale was at once undertaken. Owing to local circumstances, and contrary to usual practice, the west end was begun first. This west end was pushed forward with great rapidity, and was completed, together with its sculptures, before 1230. By 1236 the nave was opened for worship, and by 1243 the west towers had received their bells. The eastern work was then carried on with equal energy. The central upper window of the east end is dated 1269, and the cathedral was substantially completed, when, on the 16th of May in this year, the body of St. Firmin was translated into his new shrine, in the presence of the King of France and the son of Henry III., afterwards Edward I. This largest of French churches ranks also among the most perfect. The structure clearly shows that Reims had been studied, the design of the nave-bays, with their pillars, arcades and aisle windows, being practically the same. The transverse vaulting ribs are here also larger than the diagonal ribs.* The

* It has been pointed out above, p. 156, that this tradition in French work arose from the desire to echo the great arches of the crossing throughout the church. In English work the crossing arches are not so related, except at Durham, a Norman example.

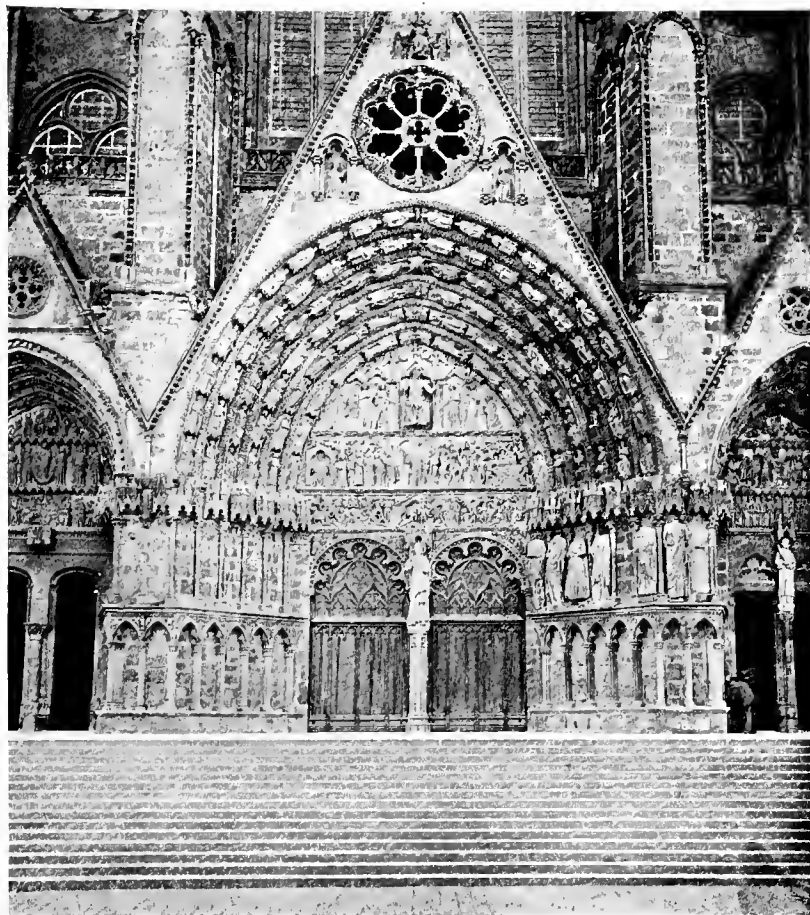

BOURGES CATHEDRAL. WEST PORCHES

greatest difference is in the much more important triforium, and in the four-light traceried windows of the clerestory, which are substituted for the abnormally wide two-light windows of Reims. The special wonder of Amiens, after the portal, is the row of windows in the transepts, three on each side (*c.* 1250). They are here of six lights, and the triforium arcade beneath them is also glazed, on a second plane of course, towards the outside of the wall. This same treatment is continued around the choir. The area of glass is thus, in this eastern limb, enormous. The end window of the north transept is of the most intricate but lovely tracery, the last step before decline. Amiens is built on a transeptal plan, but there are no transeptal towers: instead of these, enormous buttresses take the interior pressure. At the west end, again, there are not the ordinary towers standing over the last bays of the aisles, but comparatively unimportant towers with colossal buttresses rise above the two lateral porches. These are oblong on plan, being much narrower from west to east than towards the façade, and it is plain they could never have been intended to be carried up to any considerable height. The façade was probably from the first intended to finish in the square form of the present front. Over the crossing was, as at present, a slender flèche of wood covered with lead. The idea at Amiens was to enclose the biggest possible reservoir of air and light, and towers were deliberately given up. Altogether, notwithstanding its great reputation, the sight of Amiens is ever a fresh surprise. (*See* Plates 44, 45, 53-55.)

Another vast cathedral was begun at Bourges at about

the same time ; but here Notre Dame, Paris, instead of Reims, was taken as the model. In this immense church there are no transepts, and no towers other than those at the west front. Double aisles surround the apse, and continue right down the nave. Five gabled and splendidly sculptured porches at the west front give access to the nave and aisles. (Plate 38.) At Paris the two aisles are vaulted at the same height, but above the inner one there is a vaulted upper storey. At Bourges, however, this upper gallery is suppressed, and the additional height is given to the inner aisle, which is very lofty, and has clerestory windows above the outer aisle. Here, as at Paris, the high vault is of the six-celled variety. At the apse the windows are pushed high up into the vault, leaving but a thin web of stone at the back of the ribs between them ; in these webs are circular piercings, through which the light of the windows may be seen. The clerestory windows are of two- and three-grouped lights with foiled circles above, but all separate, and not combined into bar-tracery. Owing to there being no transepts, the long array of flying buttresses is here a more marked feature than anywhere else. The simple vastness of this building is wonderfully impressive, and the early glass in quantity and quality is only rivalled by Chartres.

Beauvais Cathedral is only a fragment, but the mightiest fragment in the world. Only the eastern limb and crossing were ever begun, and on the site where the nave would have been built still stands the nave of one of the most interesting early churches in France, completed about 1000, and known as the Basse Œuvre, in relation to its

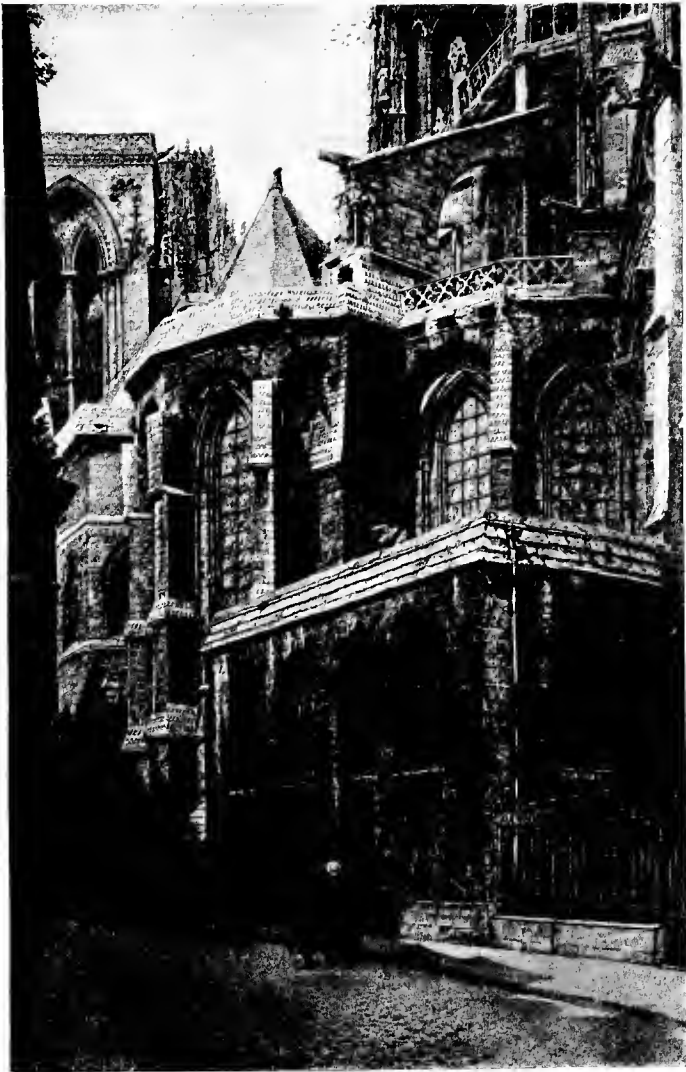

From a drawing by Mr. T. M. Rooke

ROUEN CATHEDRAL. CHOIR

Face p. 210



towering neighbour, the Haute Œuvre. The chevet was begun in 1247 and finished in 1271. Height and slightness, however, had been pushed beyond the limits of even temporary safety, and a part of the great vault fell in 1284. The dimensions, indeed, are enormous—the spans of the three bays of the eastern limb are 29.6, 28.9, and 25.9 between centres respectively. The width of the central span is 45 ft.; the crown of the vault is 150 ft. above the pavement, and the exterior ridge rises to 210 ft. It was repaired by means of subdividing the bays and other additional works. These repairs were not completed till about 1324, when the apse windows were glazed. The transepts were not completed till 1548, and, notwithstanding their former experience, a great lantern and flèche were reared over the crossing, rising to the height of 475 ft. Completed about 1555, this flèche, the last word of Gothic art, fell in 1573. In spite of its many modifications, the interior of the chevet is of the most satisfying beauty, and the exterior, as seen from the east, is quite perfect. It follows the Bourges type in the great height of the ambulatory, which is lighted by clerestory windows over the chapels. It resembled Reims in being prepared for transepts with terminal towers. It is unequalled in the window arcades of the chevet—below, through the ground arches, are seen the windows of the chapels and the clerestory of the aisle; then above, around the bow of the apse and along the clerestory, are great foiled windows, no less than 50 ft. high, close beneath which is a tall triforium passage also pierced *à jour*.

Rouen Choir belongs to the first quarter of the thirteenth

century. (Plate 39.) At the west end a supremely noble tower is of an earlier period as perhaps are two doorways as well. The circular chapels at the east end also appear to follow an older plan. Indeed, it is probable that the plan is altogether the old one with extended transepts and a few other alterations. The western towers are not at the ends of the aisles, but stand clear to the north and south, making a wide extended front, as was the case in some English cathedrals. A fine lantern which supported a tall leaded spire rises over the crossing. There are two towers at the ends of each transept, following the Chartres type. The evidence as to the west front was much obscured in the last century by the addition of other buttress masses like those two of the early sixteenth century which flank the central door. As shown in Cotman's engraving, the design of the lower stage of the west front with an arcade above the doors was easy to follow. After special examination my final opinion is that this work with the two doors mentioned above was built after 1200. (Plate 40.)

At the end of the twelfth century, in the last years that Rouen was held by English kings, "a work" was in progress; possibly the west front and north-west tower. Then, in 1200, came a great fire. "In this year," says our Hovenden, "was burnt the whole city of Rouen, with the Archbishop's church and many others." Four miserable years followed, and then Philip Augustus pushed John out of his Norman realm and capital. The building of the present church followed immediately, and it was virtually completed about 1235. The present transept-ends belong to the latter half of the thirteenth century, and the Lady

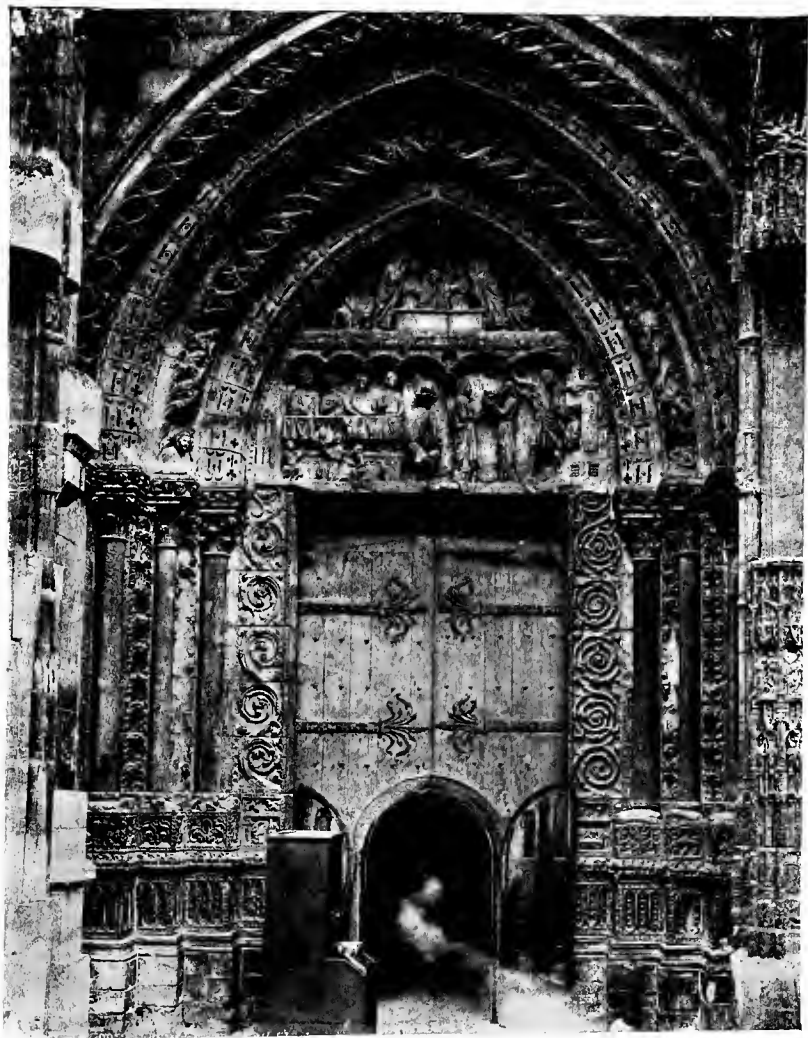

ROUEN CATHEDRAL. LATERAL DOOR OF WEST FRONT

chapel followed, about 1300. The later works are exquisite examples of the most mature Gothic construction.

The chevet of Le Mans must just be noticed as another example of High Gothic. It shares the characteristics of Norman Gothic as well as of the more strictly French style. The rebuilding of the Romanesque church was begun about 1218, but the noble transepts, with their great traceried windows, were not reached for another century, and the low Romanesque nave, with a severely beautiful west front, still remains to us. The apse is magnificent, and there is a new departure in the buttress scheme and outer chapels which was later elaborated at Toledo, which Street and other writers regard as the great consummation of apse planning. At Le Mans the buttresses over the inner ambulatory radiate in the usual way, then over the outer ambulatory, for there are two as at Bourges, each flying buttress forks into two, forming a Y. The glass of Le Mans ranks with the best.

In Normandy and Anjou the early Gothic work has well-marked differences from the French school. One of the earliest transitional examples is Lisieux Cathedral, partly built by the bishop who held the see between 1141 and 1182, and probably begun *c.* 1160. Coutances, with its tall central tower and extraordinarily romantic western towers and spires, all of early Gothic work, is one of the completest cathedrals in existence. With these must be mentioned the apse of the Abbaye aux Hommes at Caen, and also the two superb spires of its western front.

Angers Cathedral at the beginning of the twelfth century followed the ordinary form of a Romanesque church. About 1145 a work of transformation was begun

by which all the interior arcades were swept away, and large buttress masses having been built outside what had been the aisle walls, the whole was covered by a vault in a single span of about fifty feet wide. The simplicity of the plan, consisting of an unbroken cross, covered by great quadripartite vaults (those constructed over the nave were built about 1150), looks more like a separate departure than a modification of any vaults which had up to this time been erected in the Ile de France (*see* Fig. 74).

Even of the churches which I have seen, I have spoken in this chapter only of those which are of special interest in the development of Gothic architecture; but I can hardly leave the subject without at least writing the names of Autun, Avallon, Nevers, Strasbourg, Lausanne, Geneva, Dijon, Troyes, St. Omer, St. Lo, Tours, Abbeville, Bayeux, Mont St. Michel, and Cologne, which is hardly the less French for having been built beyond the boundaries of France. This last, the biggest of all Gothic churches, which was begun in 1248, is very much a combination of Amiens and Beauvais. The upper part of the nave and the west front are modern, and the whole has been passed through the mill of restoration, but nothing can destroy the beauty of the great choir and apse. Cologne marks the end of a period.

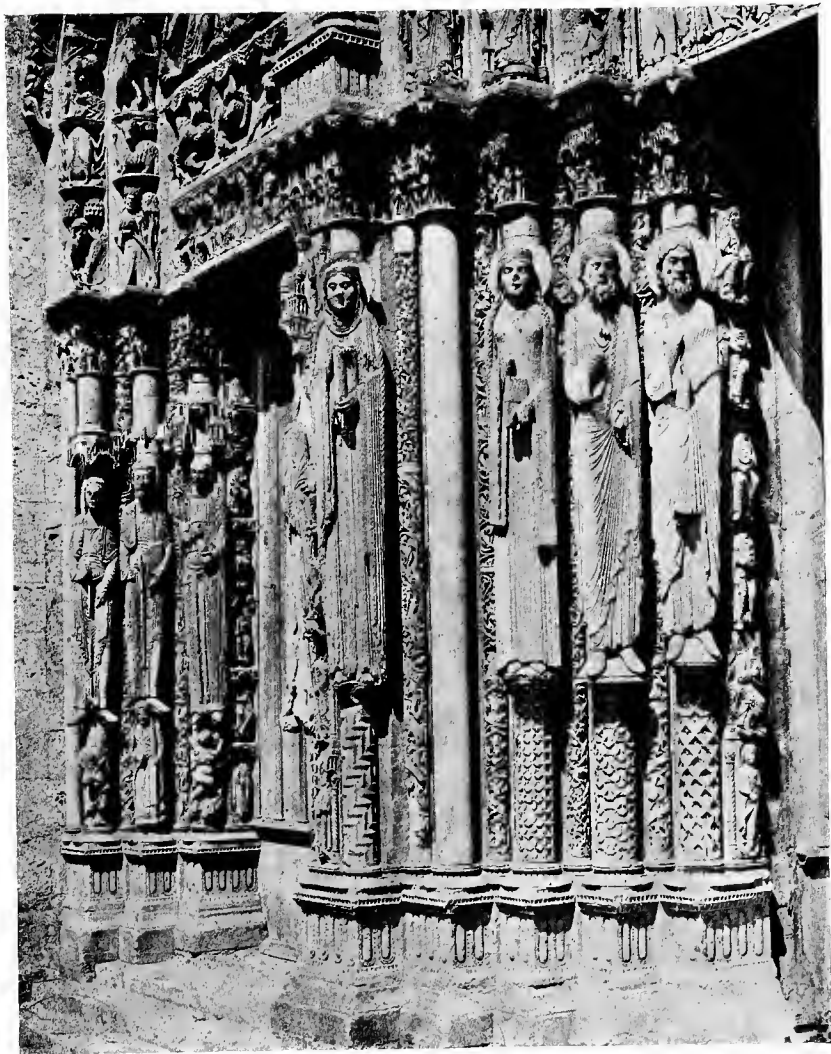

CHARTRES CATHEDRAL. SCULPTURES OF THE WESTERN DOORS

CHAPTER IX

FRENCH SCULPTURE AND PAINTING

TWICE in the history of Art has sculpture reached a mark which placed it apart from that of all other periods. The finest Greek or Gothic sculpture takes its place as the crown of architecture. Each had the power of combining many works into a great whole; in both the subject-matter is of high epic character, and the workmanship worthily answers to the intention.

The concourse of saints which peopled the deep porches of a Gothic cathedral, gleaming in fair colour from out of a shadowed atmosphere, must have intensely moved the beholders. We may readily see in Chaucer, and in other mediæval writings, how sculptured stories were seen as living dramas. Indeed, to the mediæval mind sculptures had something of the supernatural about them. They were creations; and it may be doubted, with all admiration for the stone and bronze dolls made by modern hands, whether the finest art can be produced with less imaginative emotion. As an instance, notice Dante's description of the images of the Virgin and the angel, "wherein Nature's self was put to shame." "There, sculptured in a gracious attitude, he did not seem an image

that is silent, one would have sworn that he was saying 'Ave.' And in her mien this language was impressed 'Ecce ancilla Dei' as distinctly as any figure stamps itself in wax." Still earlier, Herimann of Tournay, telling of the shrine of St. Piat, says that on it were represented the five wise and the five foolish virgins, "who all seemed to weep and to be alive; these shed tears like water, those like blood." Dante in two words defines the purpose of sculpture as "visible speech."

Sculpture of the earlier Byzantine school gradually spread over Europe; two of the best examples of the middle period are our own Ruthwell and Bewcastle crosses, works probably of the eighth century, in which are figures and groups arranged according to a well-ordered iconographical tradition. With the Secondary Byzantine school the interrupted energy in image-making burst forth anew, and in the form of ivories and metal-work figure-designs were soon distributed over the West from Constantinople, and many schools soon arose in the bronze-working centres of Germany, in North and South France and in North Italy.

We cannot follow the development of sculpture through the Romanesque period in detail, but I must make a passing reference to the bronze font at Liège, of which there is a cast at South Kensington, which is the most remarkable work of art, in an historical sense, of any known to me. It is known to be the work of Renierus, a goldsmith of Huy, near Dinant, and was cast about 1115. It is a circular vessel, surrounded by subjects from the life of John the Baptist in high relief, and standing on twelve oxen. Long inscriptions accompany the scenes. The

group of the Baptism of Christ is of extraordinary beauty. Three "ministering angels" obedient, solicitous, rejoicing, express the most perfect angelic naturalism. John, preaching to the people to bring forth the fruit of repentance, is of equal beauty. The listening group of "publicans," with a Roman soldier, is exquisite. I must confess that I do not understand the lineage of the style of sculpture of this outstanding work. It is so free, and there is no touch of archaism. As bronze-casting it doubtless derives from the German schools, and Byzantine influence is evident in the composition.

In the following short account of French sculpture I have, instead of trying to describe indescribable beauties, endeavoured to give a synopsis of the sequence of the chief groups and a brief summary of the subjects treated.

In France a great school of sculpture had been developed in the royal domain by the middle of the twelfth century. The array of figures at the royal doors of Chartres are the best known examples; but two lovely figures of a king and queen from Corbeil are even more perfect.

The question of the relationship of the master of the west portals of Chartres to the school which worked at Arles was raised by Vöge, but Lasteyrie seems to have shown conclusively that the Chartres group did not derive from Arles. At St. Gilles some of the earliest of these southern sculptures go back to near 1150 and the sculptor Brunus has signed some of the figures. The sculptures at Arles, however, were not wrought till about 1180-90. At the same time it does seem to me that the Southern school may have had an independent origin.

The figures of the securely dated Gloria doors of St. James of Compostella (1188) are very different in their sentiment of dramatic action to the placid figures of Corbeil and Chartres; moreover, they are quite as advanced as any

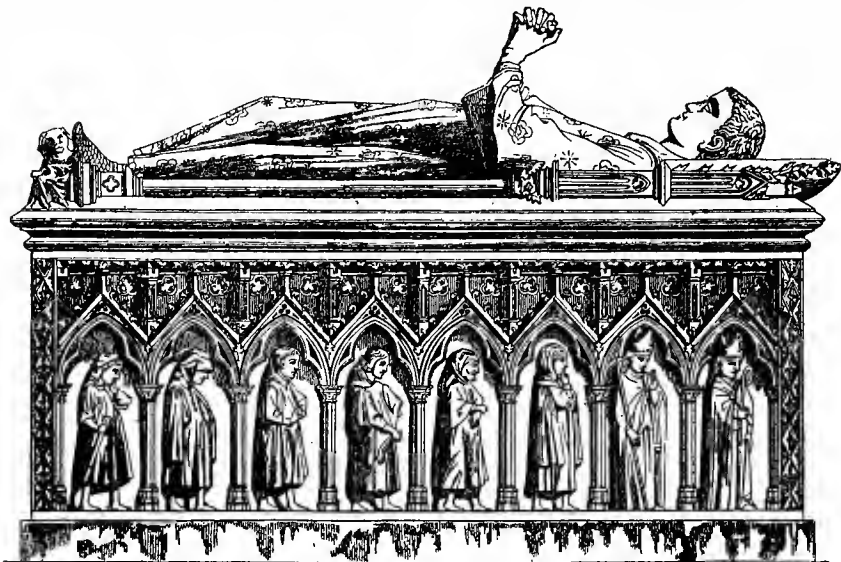

FIG. 93. Tomb of Louis, eldest son of Saint Louis, at St. Denis, *c.* 1260.

other works of the same date. The scheme, however, is evidently derived from Chartres.

The west portal at Chartres belongs to the period 1150-75, but a door at St. Denis, entirely similar in style, went back to 1142. Several other portals exist which follow the same type; one of these at Le Mans Cathedral, which was set up sometime before 1186 (probably *c.* 1170), is of special interest to us, as it is probably the prototype

of the west door of Rochester, which, in any case, is an offshoot of this school.

The sculptures on the triple portal of Chartres comprise some 720 figures, large and small. In the middle tympanum is Christ in Majesty, surrounded by the symbols of the Evangelists, with the Apostles below. Around the arch are angels and the twenty-four elders. The tympanum of the right-hand door is devoted to the life and glorification of the Virgin, the arch sculptures represent the seven liberal arts. The tympanum of the north door has the Ascension for its subject, and the sculptures of the arch are the zodiac and the labours of the months. The twenty-four great statues standing against the pillars of the doors are the ancestors of the Virgin, as has been recently shown by Vöge and Mâle. Here and there are traces that the sculptures were formerly covered with bright colour and gold. (Plate 41.)

At Reims there is a small portal which has been preserved in the north transept, which is an exquisite transition work, and still richly coloured.

The tympanum of St. Anne's door, one of the three western doors of Notre Dame, Paris, that to the south, was also preserved from the antecedent building. This has such close affinity with one of the Chartres door-heads that it is thought it must be either the work of the same master or of a pupil; it was wrought about 1185. The two figures of a bishop and a king kneeling before the Virgin are Maurice de Sully, the bishop, and Louis VII. There are fragments of the jamb statues at the Cluny Museum.

The west portal at Senlis is probably the best example



FIGS. 94 and 95. Effigies called Childebert I. (wrought *c.* 1150) and Clovis II. (XIIIth Century) from tombs at St. Denis.

of earliest Gothic sculpture. In much it follows the royal doors of Chartres, but it is a whole step in advance. In

the tympanum is a strikingly beautiful and solemn Coronation of the Virgin, her Death, and Assumption. The column-figures are typical characters—under the old and new laws—Abraham with Isaac, Moses with the pillar which bore the brazen serpent, Simeon with Christ in his arms, St. John Baptist, and others. The heads have been very badly restored, but types so similar are found at Chartres and Reims that we can only suppose that they were copied, with slight differences, one from the other. This work seems to date about 1190. Considerable vestiges of colour still remain. These sculptures, according to E. Mâle, follow the scheme of Isidorus by which Adam, Abel, Noah, &c., were all in certain aspects types of Christ.

The next step seems to have been made in the triple porches at Laon. Here the column-figures, the old ones having been destroyed at the Revolution, are now entirely modern. The ancient central tympanum represents the Virgin's Coronation; around the arch is a fine stem of Jesse. The north porch has in the tympanum scenes from the life of the Virgin; the arch sculptures are of types of the Virgin, which, as M. Emile Mâle has shown, follow those given in a sermon of Honorius of Autun; the Virtues and Vices, &c. The south door represents Christ in Judgment; in the arch-orders are angels carrying souls to glory, and the wise and foolish virgins. Above, around one of the windows, is one of the finest sets of the seven liberal arts. A good deal of colour remains, and the subjects had written titles. The little north door has some pretty reliefs, which, I believe, have not been identified. Comparison with the north door at Reims shows that the subject was the Martyrdom of St. Nicaise.

Amongst some fragments preserved in the chapel of the bishop's palace is a queen's head (Sheba ?) of the greatest beauty ; except for some marks of violence, the surface is in good condition, and still shows faint traces of paint.

There are two charming pairs of figures on the west front of St. Martin's, Laon, where angels with candlesticks guide bishop-saints to heaven.

In referring to these last three I have stepped aside from chronological order, to which I will now return.

At Chartres, beside the western portals, which belong to an earlier building, there are vast triple porches to both the transepts, each containing a crowd of statues. The design of the porches, and several of the details, show close affinity with the work at Laon. The whole north porch is dedicated to the Virgin. On the central door-post is St. Anne with the Virgin in her arms ; in the tympanum is the Coronation of the Virgin, and in the arch are ancestors of the royal line. The large free-standing figures are Old Testament types of Christ. Abraham, Moses and Samuel are almost exactly like those at Senlis ; the Story of the Creation is figured on the outer arch. In the tympanum of the left-hand bay is the Nativity. In the arches are the Virtues and other subjects, and in the exterior arch heavenly Beatitudes. Two of the exterior statues against the pillars were, before 1793, impersonations of the Church and the Synagogue. The jamb statues are groups of the Annunciation and Visitation. (Plate 42.) Above the right-hand door is Solomon judging between the two women. In the arch are angels carrying sun, moon, and crowns, also types of the Virgin in the stories of Gideon, Esther, Judith,



CHARTRES CATHEDRAL. JAMBS OF LEFT-HAND AND CENTRAL
DOORS OF NORTH PORCH, THE VISITATION, ETC.

Tobit, and others. Around the exterior arch are the signs of the zodiac and labours of the months. Amongst the standing figures here are a beautiful pair of the Queen of Sheba and Solomon. On the outer pillars are local saints.

In the three porches of the south transept the central bay contains Christ in Judgment above the door, and below are statues of the Apostles. In the arch are the nine orders of angels. In the left-hand porch the tympanum is given to the first martyr, and the standing figures are of martyrs—Saints Vincent, Laurence, and Stephen, deacons; Saints George and Theodore, warriors; St. Clement, Pope. (Plate 43.) The right-hand bay is assigned to confessors. The tympanum is given to St. Nicholas and St. Martin, and below are statues of the same saints, and of the doctors Jerome and Gregory.

For the last word on the attribution of these statues, and the best account of Cathedral Iconography generally, I must refer to M. Emile Mâle's "L'Art Religieux," 1902. It must suffice to say that the whole assemblage is incomparable in magnitude and in beauty, save only with Reims. Certain statues of the porches have been named after historical personages—the King of France, Richard Cœur de Lion, the Count of Boulogne and Countess Matilda, &c. Mâle points out that the reliefs under the so-called Philip Augustus and Richard treat of Saul and David. Under the Count of Boulogne is a figure inscribed "Jesse." Another group of statues represents Eli and Samuel with Samuel's father and mother, the names of whom appear on the explanatory reliefs. As Mâle has shown there was nothing of caprice in the iconographical schemes of the Cathedrals, they were evidently prepared by the most

date from about 1210 (in 1204 Chartres acquired the head of St. Anne, who appears on the trumeau of the north porch). One plan seems to have been adhered to from the first, but development may be seen in the workmanship. Among the most mature of the statues are the local saints of the north porch, and Saints George and Theodore of the south. There are many traces of colour.

Some reliefs from the life of the Virgin preserved in the crypt, which came from the destroyed pulpitum, are of the highest order. The Nativity, and the Three Kings sleeping, should on no account be missed.

In quality the sculptures of the west portals of Notre Dame, Paris (*c.* 1220), are unsurpassable, but they were much injured at the Revolution. Christ in Judgment filled the central door. The great broken lintel figuring the Resurrection (fragments are in the Cluny) was superb in composition and execution, and on the basement is a very interesting series of Virtues and Vices. The Virgin's, or north door, is more perfect and very lovely. The high tympanum is divided into three bands; below are three prophets and three kings of Judah: next comes the Assumption of the Virgin, and above, her Coronation. The smaller subjects on the jambs and basement are marvellously vivid inventions of the signs of the zodiac, and labours of the year. Notice especially the May, a young man with a bunch of roses and a spotted thrush; and June, a mower sharpening his scythe. There are also two reliefs of Sea and Land, the latter a stately seated woman holding types of vegetation in her hands. Traces of painting may still be discerned. The doors of the

south transept are also of great beauty. The Virgin's door in the west front is so like one of the Amiens doors that it is certain that one is copied from the other. Across the fronts of both these cathedrals are galleries of niches containing colossal figures of kings—at Paris of twenty-eight (renewed), and at Amiens of twenty-two. They have been known as kings of France; but Didron, Viollet le Duc, and recently E. Mâle, have argued that they are the royal ancestors of the Virgin.

The lower storey of the west front of Amiens is taken up by three deeply recessed portals, only divided by the bases of the buttresses. Fifty-two statues of heroic size standing above the basement form a continuous band right across the front and going into the deep recesses of the porches. The mid-post of the central door supports a statue of Christ Blessing; in a niche below is a king who used to be called David, but is now supposed to be Solomon. Above, in the tympanum, is Christ come to Judgment: the Virgin and St. John plead on either hand, and, beyond, two angels bear the cross and spear; below is the Separation of the Blessed and the Lost. The arches are filled with a host of angels and saints and ancestors. The door-posts are sculptured with five wise and five foolish virgins, who stand on one side over a fig-tree in which birds build their nests, and on the other over a withered tree half severed by an axe. The basement of the deep slanting jambs bears a number of quatrefoils containing beautiful versions of the Virtues and Vices; the free statues above are the twelve Apostles. Two next the outer angles on each side are the four major prophets, and



AMIENS CATHEDRAL. SOLOMON AND SABA.
FROM THE SOUTH DOOR OF WEST FRONT



FIG. 98. Effigy of Phillippe III. at
St. Denis, c. 1307.



FIG. 99. Effigy of Jean II. at
St. Denis, c. 1364.

twelve other prophets occupy the faces of the four buttresses. On the mid-post of the south door stands a very noble figure of the Virgin over some reliefs of the Fall of Man; above her head is the Ark of the Covenant. On either side of the Ark, on the lowest band of the tympanum, are three seated prophets; this is especially like Paris. On the sloping sides of this porch the statues refer to the life of the Virgin—the Annunciation, the Visitation, and the Presentation, the Three Magi and Herod, also Solomon, and the Queen of Sheba. The identifications are certain in every case, as the quatrefoil reliefs refer to the figures beneath which they are sculptured; thus, beneath Solomon and the Queen of Sheba, Solomon is shown seated on the lion-throne and welcoming the queen. In the tympanum of this door are figured the Burial, Assumption, and Coronation of the Virgin. The north door is devoted to the local saints. The quatrefoils here contain the signs of the zodiac and the labours of the months—a magnificent set. Under the prophets the reliefs are of their typical prophecies, which are rendered with great imagination. Notice the Desolate City inhabited by unclean beasts, the Heavens stayed from dew, and, indeed, all of them. High up on the south side of the south-west tower is a colossal angel standing over a sun-dial, which may be compared with dial-bearing angels at Laon and Chartres. The sculptures of the south transept door are about twenty years later than those of the west porch, which were wrought soon after 1220. (Plates 44-45 and 53-55.)

Of all sculptured fronts, that of Reims is the triumphant consummation in scale, perfection of execution, and fascina-



AMIENS CATHEDRAL. HEROD AND TWO OF THE MAGI.
FROM SOUTH DOOR OF WEST FRONT

tion. As to design, it certainly follows that of Amiens. It is held that a concourse of masters from the various French schools gathered here, and the work seems to be the outcome of a furnace of intense creative energy. Here again three vast gabled porches stretch across the front. The tympana over the doors are pierced with rose windows, and the sculptures of the Coronation of the Virgin, and the rest, which usually fill them, are thrust up into the gables above, where they are surrounded and canopied by a marvel of tabernacle work. Small reliefs fill narrow flanking gables at the extreme ends of the front; and it looks as if, as has been suggested, these had been prepared for the tympana and were pushed aside by a change of plan in favour of piercing them with windows. On the mid-post of the centre porch are the Virgin and Child, probably the most perfect mean between the earlier and later Virgins at Amiens. Along the deep slanting sides of the porch stand statues eight or nine feet high setting forth the story of the Virgin's life. To the right two pairs show the Annunciation and the Visitation; in the latter the figures are strikingly Greek in character. Opposite these is the Presentation in the Temple, Mary with the Child, Simeon, Anna, and Joseph (Plates 46-49). The Virgin in this and in the Annunciation resembles those at Amiens and Chartres. At the outer angles are Samuel and Saul, whom he anointed king, in reference to the use of this cathedral for coronations. Beyond these, again, on the face of the buttresses, are particularly romantic statues of Solomon and the Queen of Sheba, who evidently find their place here, as at Amiens and Chartres, on account of the saying of Christ: "The Queen of the

South . . . came from the ends of the earth to hear the wisdom of Solomon ; and, behold, a greater than Solomon is here." The north porch is devoted to local saints. Here the martyred Nicaise, with an advance on Amiens, carries only the crown of his head, instead of the whole head, as do the local martyrs there. The Bishop's face shows a perfect characterisation of patient suffering ; he is led forward by two smiling angels.

It is the south door that has the series of types of Christ—Moses, Samuel, and others—which have before been spoken of as like those of Senlis and Chartres. The doorways of the north transept are also fully sculptured, the middle one with the stories of Saints Nicaise and Remi, and the left-hand one with a noble Last Judgment, treated as at Amiens. In the archivolt are small figures of the wise and foolish Virgins. Above the former is a gate with open doors : above the latter the doors are closed.

The west front of Bourges has five great sculptured doorways, of which the reliefs rank amongst the finest, but most of the standing figures have been destroyed. Above the central door is Christ in Judgment, beneath whom is a delightful smiling Michael weighing souls, and processions of the Blest and Lost. The former seem to be led by St. Louis and St. Francis ; the personages in this group are smiling with almost excessive evidence of felicity. It seems to have been Bourges from which German sculptors took this trait which they further exaggerated. The reliefs in the spandrels of the wall-arcade below are marvels of design and cutting. In one are Adam and Eve amongst the fruit-trees of Paradise ; in another a fawning dragon-

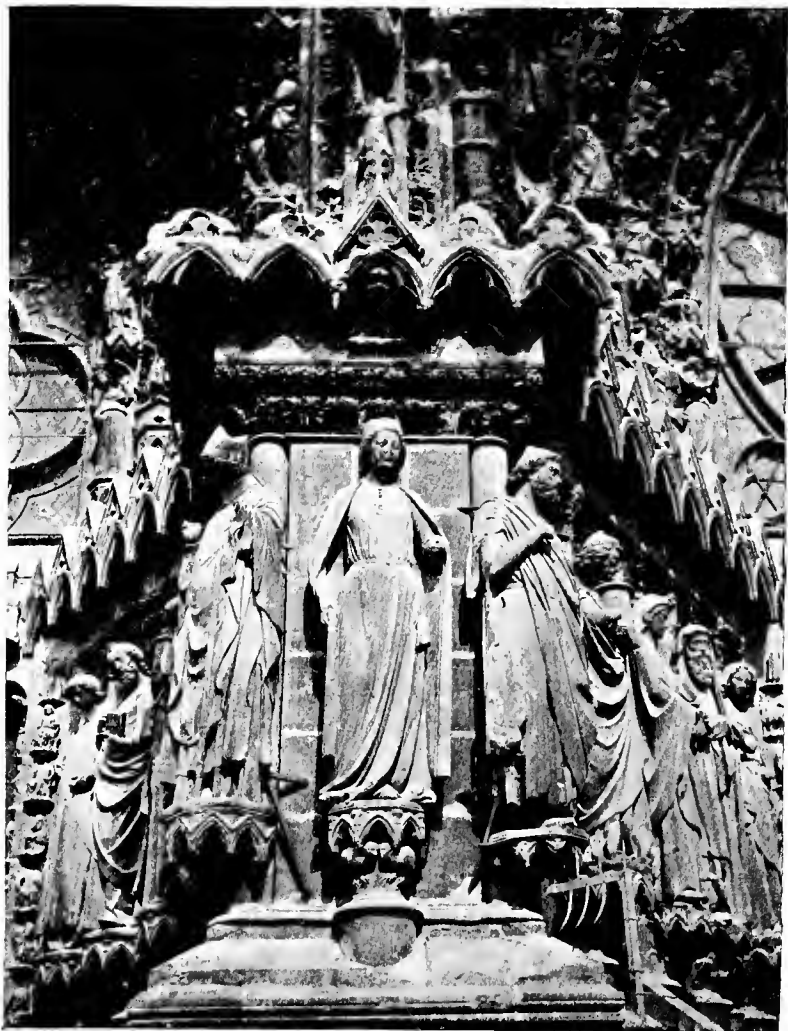

REIMS CATHEDRAL. LEFT-HAND JAMB OF CENTRAL PORCH. THE
 QUEEN OF SHEBA, SAMUEL, THE PRESENTATION, ETC.

serpent licks his lips before Eve; and another shows the Deluge drowning mankind. Ruskin picked out these as the finest spandril reliefs he knew. In the Louvre are fragments from the pulpitum, being subjects from the life of Christ in a particularly noble style of high relief.

The west portals of Auxerre and Sens must also be counted among the great examples of sculpture; also the north-west door and the transept doors at Rouen. In the last are scores of little quatrefoil panels filled with stories from the Creation onwards (Plates 50-51).

A treatise by Dr. Franck-Oberaspach has lately shown that the exquisite sculptures of the Church and Synagogue on the south transept of Strasbourg must be considered as the work of a master who had worked on the porches of Chartres. The wonderful "Angel pillar," or rather Judgment pillar, in the same cathedral seems to be by the same hand, and is plainly a development of the statue-bearing pillars of the north porch of Chartres. There are three tiers of figures, being the four Evangelists, four angels calling to judgment, and Christ accompanied by three angels bearing instruments of the Passion (Plate 52).

Of the two figures which symbolise the strife between the New Law and the Old, the Church is radiant and with a touch of scorn; the Synagogue, with eyes bandaged, droops her head till the crown falls and the staff she leans on breaks like a reed. Of later date, and of the German school, are the sculptures of the western portal; but two features must be referred to. Filling the gable over the central door is a finely designed Solomon on his throne of seven steps with as many pairs of lions. The twelve statues at one of the doors figure the story of the wise

and foolish Virgins. On one side the wise are led by Christ, the Holy Wisdom, and on the other the foolish are attracted by Folly, a fair-seeming youth with a fine mantle in front, but naked behind and his back covered with toads and serpents. The same artist may have done a similar series at Freiburg, where there is also an interesting set of isolated statues of the seven Liberal Arts all prettily coloured.

I have noted that most of the sculptured stories of cathedral fronts still show many traces of the colour and gold with which they were once illuminated. The best preserved of these painted statues in place are probably those in the south porch of Lausanne Cathedral, which have their garments diapered and bordered with dainty patterns. At Reims, one or more of the figures show a similar treatment, and the shafts between them have traces of chevron patterns. A visitor to Paris in the time of Charles VIII. noted that the west front of Notre Dame was ornamented with gold and painted with divers colours. The Christ of the central door and the Virgin above in the middle of the front were especially splendid, but all the sculptures were decorated. Fig. 102 may help us to realise this. Piecing together the fragmentary evidence makes it clear that all exterior sculpture was intended to be painted as part of the traditional finish and to protect the stone from decay. It is to this skin of paint that we owe the preservation of so many of these works, which in most cases have suffered little or nothing from the weather, but only from violence.

The method of treating a great scheme of sculpture,



REIMS CATHEDRAL. JOSEPH; FROM THE PRESENTATION GROUP,
PLATE XLVI



REIMS CATHEDRAL. SIMEON; FROM THE PRESENTATION GROUP,
PLATE XLVI

like a west front, was to wash the whole with ochre; to



FIG. 100. Effigy of Robert d'Artois at St. Denis, c. 1317.



FIG. 101. Effigy of Marguerite d'Artois, St. Denis, c. 1311.

paint certain niches and hollows red, green, and blue; to

fully decorate the images and write inscriptions on the scrolls they bore; and then to touch certain details with gold. The finished front was fair and sparkling exactly like a colossal painted ivory triptych. From the front the colour and gold spread to the lead roof, the crest was gilt, and at times the slopes were diapered with a big pattern. The flèche would be fully decorated, and at Châlons the west spires had the leadwork covered with figures and canopies painted much in the style of colossal enamel work.

The effigies of French tombs are fully as fine as the exterior sculptures. The effigy of Louis, son of St. Louis, at St. Denis, is beautiful beyond all praise. Smiling, his hands are energetically pressed together, as if he saw a vision (Fig. 93). Our Henry III., who attended the funeral of the prince, appears amongst the mourners on the tomb. The figures of a youthful knight, Robert d'Artois, 1317 (Fig. 100), and Philippe III. (Fig. 98), both in the same church, are equally noteworthy. The Robert d'Artois was the work of *Jean Pepin, bourgeois de Paris et tombier*. A still more famous master was André Beauneveu, *imager* to Charles V., who wrought the king's tomb and those of Jean II. (Fig. 99) and Philippe de Valois. I give after the *Annales Archæologiques* Figs. 93-101, from the tomb effigies of St. Denis. In Fig. 94, which is a memorial effigy wrought about 1150, we have in the cast of the drapery an evident reminiscence of Byzantine design. The same tradition appears in the effigy of our Henry II. at Fontevrault. Figs. 95, 96, 97 are also ideal memorial effigies; the Figs. 98, 99 of Philippe III. and Jean II. were evidently portraits; the former was wrought in 1307 by Jean d'Arras and Pierre de Chelles.



REIMS CATHEDRAL. CENTRAL PORCH. ANGEL OF THE
ANNUNCIATION GROUP

It is interesting that the names of several of the Gothic sculptors have been preserved. Robert de Launay, *imager* of Paris, who was killed at the battle of Poitiers, wrought for the chapel of S. Jacques aux Pèlerins, about 1320, large statues of Christ, Apostles, and Angels. The Apostles were placed against the twelve pillars of the chapel, which being destroyed in 1808, five of the statues found a resting-place in the Cluny Museum. Jean le Bouteiller, another Paris image-maker, made the beautiful Biblical stories of the choir enclosure of Notre Dame, completed in 1351.

Still another famous sculptor was Jean de Cambrai, the sculptor of wonderful images on the tomb of the Duke of Berry, once at Bourges, and now destroyed, but of which beautiful drawings made by Holbein have been preserved.

At Dijon is a group of sculptures by Claux Sluter and his nephew. These comprise the celebrated Well of Moses and the Tombs of Philippe le Hardi and of Jean Sans Peur.*



FIG. 102.
Painting a
statue, from
a MS.

It appears from the names of several of the great artists working in France from the middle of the fourteenth century, and from the character of the work wrought at this time, that the leading influence was then Flemish rather than French. The most famous artists of the time bore such names as Pépin de Huy, André Beauneveu of Valenciennes, Claux Sluter, Jean de Cambrai, Hennequin de Liège, &c. In England, in 1367, when Edward III. erected a tomb to his wife in

* See S. Lami's important "Dict. Sculpt. Français," 1898.

Westminster Abbey it was ordered from one "Hawkin de Liège of France," doubtless the last named, and is of the fashionable Flemish style. In painting the climax of this



FIG. 103. Daughters of Sion, from stained glass at Orbais (XIIIth Century).

school was reached by the great world-artist Jan Van Eyck, of Bruges, who himself served the French king.

In France a good deal of critical attention has been given to the national painters of an early date. Several important books have been devoted to them, and it is there fully understood that these painters are of as much

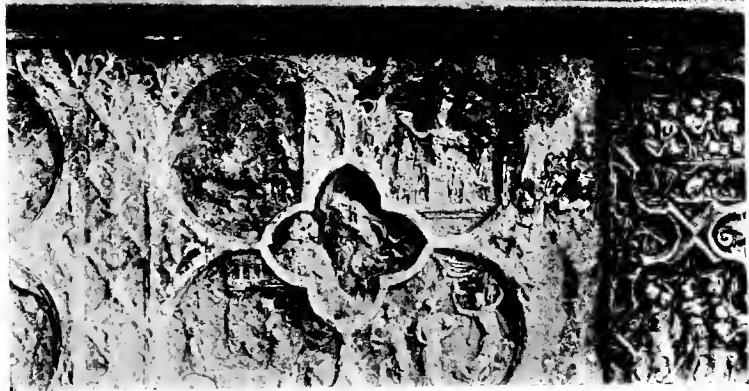

AUXERRE CATHEDRAL. SCULPTURES OF THE WEST PORCH



AUXERRE CATHEDRAL. SCULPTURES OF THE WEST PORCH

importance to the history of French art as a Giotto and other early masters are to that of Italy.

From the tenth or eleventh century, vestiges of wall-



FIG. 104. Moses, from stained glass at Orbais (XIIIth Century).

paintings still exist, such as fine Majesties and Virgins in apses, rows of prophets, Bible histories, &c., mostly large in scale, hieratic in treatment, and presented in fair, frank colours, and in a style flowing from Byzantine sources. Poitiers and its neighbourhood is the best district in which to study early French wall painting. St. Savin, which

may be seen in an excursion from Poitiers, is a splendid Romanesque abbey church, which is almost entirely covered with paintings, as also is the circular chapel of St. Jean de Liget in the forest of Loches:



FIG. 105. A study by V. de Honnecourt.

At the end of the thirteenth century, Master Étienne d'Auxerre was in the service of Philippe le Bel. In 1308, Philippus Rizuti of Rome was *Pictor Regis*. He, his son, and another, "three painters of Rome," are mentioned as late as 1317. "He is probably the same as the Philippus Rusutus who, at the beginning of the fourteenth century, signed one of the mosaics of the façade of S. M. Maggiore, Rome."

One of the most important painters of this time was Master Evrard of Orléans, who worked in the royal palaces up to the middle of the fourteenth century; he, it is said, was also a sculptor and an architect.

Figs. 103 and 104 from stained glass may suggest in some degree the thirteenth-century style of drawing and composition. Fig. 105 is a sketch by Villars de Honnecourt.

About 1350 Jean Coste painted a palace chapel for Jean II. "in fine oil-colours; the field of fine-patterned

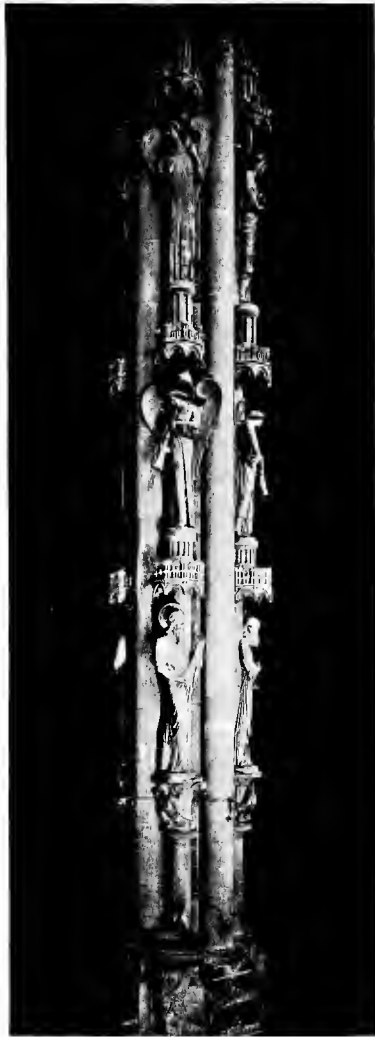

STRASBOURG CATHEDRAL. CENTRAL PILLAR IN THE SOUTH TRANSEPT

Face p. 238

Face p.

Face h.



gold and the vestments of Our Lady in fine azure.”
Of this King John, taken prisoner at Poitiers by the



FIG. 106. Portrait from incised grave-slab at Châlons-sur-Marne.

Black Prince in 1356, there remains a portrait on a gilt ground raised in patterns, which may be the work of Coste, or more probably of Gerard d'Orléans. In 1368–80, Jean de Bruges was *Pictor Regis* to Charles V. An



FIG. 107. Portraits from incised grave-slabs at Châlons-sur-Marne.

inventory of 1399 notes a painting in four leaves having the portraits of Charles V., Jean his father, the Emperor his uncle, and the King of England, Edward III. This precious picture, containing a portrait of Edward III., is unfortunately lost.

Another important master was Jean d'Orléans (1361-1408), *Pictor Regis*. But the most famous master of the fourteenth century was Charles V.'s painter, "Nostre aimé Andrieu Beauneveu, nostre ymager," who is mentioned by Froissart as "Maistre de ses œuvres de taille et de peinture" to the Duke of Berry. He has already been spoken of as a sculptor. That accurate portraiture was well understood at this time we may gather, if it needs proof, from the account that when Charles VI. was about to marry (1385), painters were sent abroad to bring him portraits of marriageable princesses. Isabella of Bavaria was approved as *belle, jeune et gente*. Figs. 106, 107 are from engraved tomb slabs of a still earlier time (c. 1300), and can hardly be other than portraits. They come from the cathedral of Châlons-sur-Marne, the floor of which seems to have been almost entirely covered by such graves.*

In 1425, Jan Van Eyck entered the service of Philippe le Bon. Of the native artists painting in the middle of the fifteenth century, the most famous is Jean Fouquet of Tours.

Little remains to us of the heyday of art from 1250 to 1350 on the walls and vaults of the cathedrals. One of the most interesting series of paintings was only

* On some supposed portrait sculptures of St. Louis and other royal persons, see *Gaz. des Beaux Arts*, 1903, p. 177.

recently discovered on a cupola at Cahors, which was decorated, about 1300, with colossal prophets, fifteen feet high, standing in tabernacles, and painted on a bright red ground in an egg medium. The painted books of the great time, however, are as perfect as when first the azure was laid and the gold was burnished. It is from these we may best gain an idea of the painted interiors of the period when France led the way in art, in painting no less than in sculpture and building. Window-glass, tapestry and wall-decoration were but offshoots of that art which Dante says "in Paris is called illuminating."

Since this short note on French painting, in which I followed in the main the volumes of Gélis Didot and Laffilée and of Paul Mantz, has been in type, a collection of "Primitifs" which has been gathered together at the Louvre has excited much interest. This exhibition could, of course, only deal with movables, and the earliest work shown is the portrait of Jean II., which is assigned to Gérard d'Orléans, who, it is thought, painted it in England (*c.* 1359), when he shared the captivity of the king, and that it formed part of the four-fold picture of royal portraits mentioned above. In the catalogue of this collection a claim is advanced that the famous Wilton diptych is a French work painted at Calais on the occasion of the marriage of Richard II. with Isabella of France in 1396. This is not at all so certain. It has always been held that this picture is considerably earlier than the date of this marriage, and there is probably more work in England to which it can be likened than there is in France; for instance, the magnificent Westminster portrait of Richard II. known to have been painted



AMIENS CATHEDRAL. RELIEFS OF THE VIRTUES AND VICES,
FROM THE WEST FRONT; BUILT BY ROBERT OF LUZARCHES

Face p. 242

in, or before, 1396, for a place in the stalls of the Abbey Church. In this superb work, surely the finest fourteenth-century portrait in Europe both for dignity of design and fine colour, the background is patterned over with raised gilt gesso, as is the Wilton diptych. In the almost unknown paintings of the Majesty and the Coronation of the Virgin on the tester of Richard's tomb, also painted in or before 1396, we have a similar treatment, which was in use in England at latest from the time when, in 1300, Walter of Durham, Edward I.'s master painter, decorated the Coronation chair. Again, we are far from knowing all the able painters who worked for the luxury-loving King Richard II. A chance entry in the St. Paul's documents shows that in 1398 Herebrecht of Cologne, citizen and painter of London, was engaged in painting a splendid picture of St. Paul surrounded by a tabernacle for the High Altar of the Cathedral. I am not so much expressing doubt as to the Wilton picture being by a French master, but to the assumption that it was painted in France on the occasion suggested. The exquisite Westminster retable (c. 1260-70) was, I have no doubt, painted in Paris and sent to Henry III. as a gift from St. Louis, the fleur-de-lys and castles of the decoration suggest this, so also do the inlays of blue glass patterned over with gold, a method of decoration extensively used in the Ste. Chapelle. Mr. S. C. Cockerell has pointed out to me that a curious pattern on the painting, resembling somewhat a Cufic inscription, is a favourite decoration on books painted for St. Louis.

CHAPTER X

FRENCH MASONS

IN France much attention has been devoted to the study of the mediæval masters of masonry, the memory of whom has nowhere been so completely lost as here in England. Durand, writing of how Amiens Cathedral was built (G. Durand, "Cathédrale d'Amiens," 1901), says that that which we understand by architect did not exist in the Middle Ages—neither the name nor the thing. The plans were drawn by the master mason if the work was of stone, by the master carpenter if of wood. The execution of the work was confided to a master mason or a master carpenter.

Thevet, in 1584, gives the life of one such master mason in his collection of illustrious Frenchmen.

Félibien also collected much information. One of the first works in France which the latter assigns to definite masters was the church of St. Lucien at Beauvais, rebuilt about 1078 "by two workmen, Wormbold and Odon, who are only mentioned as cementarii, for the word 'architect' was then little used, and they gave the name of 'mason' to those who made profession of the art of building." In 1887 appeared C. Bauchal's "Biographical Dictionary of French



AMIENS CATHEDRAL. THE SIGNS OF THE ZODIAC AND THE
LABOURS OF THE YEAR

Architects," which is so thorough that it would be vain to attempt to make extracts from it. In it we can follow in many cases the succession of masters at several cathedrals over the space of centuries. In the case of Troyes, particulars as to some seventy workers are given. I shall only here touch on a few leading cases, in the main gathered from sources published since Bauchal wrote.

An ancient inscription, connected with a labyrinth, inlaid in the floor of Amiens Cathedral, set forth that Master Robert of Luzarches, master of the work, began it in 1220. This labyrinth was an octagon filling the floor of two bays of the nave. At the centre was inlaid a cross of bronze, and also incised effigies of Evrard, the bishop who began the work, and of three masons who built it. This central slab was preserved when the labyrinth was destroyed in 1825, and a copy of the whole composition has recently been laid in the place it once occupied. Robert of Luzarches was followed by Master Thomas de Cormont, who was succeeded by his son, Master Regnault, who, as the inscription read, "put the writing" in the year 1288. Over the south transept door is the remnant of a still earlier inscription in large letters (c. 1240) stating that the first stone was laid in 1220, and there the name of Robert again appears. A deed of 1260 mentions Master Renaud, cementarius, master of the fabric. The third master was, therefore, in charge from before 1260 to after 1288, and to him must be attributed the higher parts of the choir. The inscription of 1288 marks the date of the laying down of the marble floor of the nave, necessarily one of the last works. When I first



FIG. 108. Hugh Libergiers, Master mason of Reims (lived c. 1190-1263).

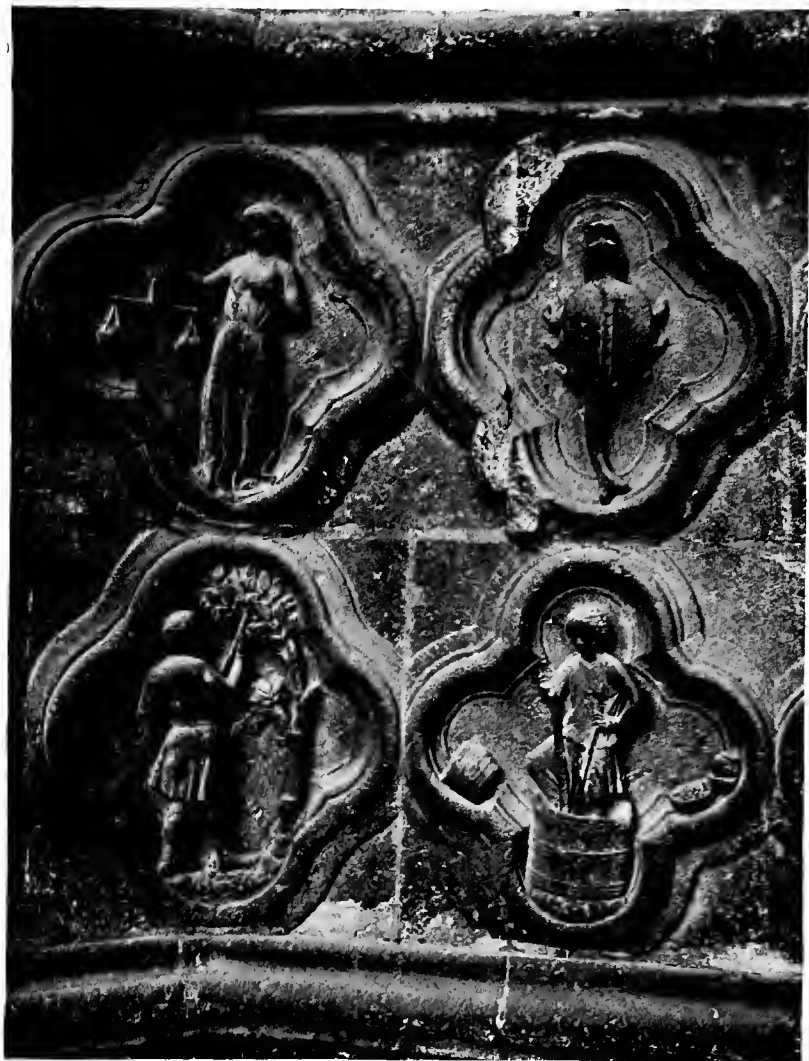

AMIENS CATHEDRAL. THE SIGNS OF THE ZODIAC AND THE
LABOURS OF THE YEAR

saw Amiens much of the original pavement was still in place; now all has been renewed.

One of the most perfect Gothic churches in France, of the great period, was S. Nicaise at Reims, destroyed a century ago, but of which good illustrations remain to us. It was begun in 1229 at the west end; a nearly contemporary chronicle of the Abbey of S. Nicaise says that "Hugo Libergiers, pronaon ecclesiæ, perfecit. Robert de Coucy, caput ecclesiæ, construxit." The latter also, we are told, made the chapels of the choir and the high vault of the cross. Master Hugh died in 1263, and was buried just within the entrance. In Reims Cathedral the grave-slab of this master mason is still preserved. The engraved lines of the finely drawn figure are filled with lead. He holds in his hands a model of the church and his measuring-rod, while on the field are depicted square and calipers. Around the border is inscribed:

"CI GIT MAISTRE HUES LIBERGIERS QUI COMENSA CESTE EGLISE EN L'AN MCCXXIX. . . . ET TRESPASSA L'AN MCCLXIII. . . ."

In the cloister of S. Denis, Reims, Félibien noted the gravestone of Robert de Coucy, "*Maistre de Notre Dame et de S. Nicaise, qui trépassa en l'an 1311.*" We have thus a complete record of the two masters who built this church.

Of the masters of Reims Cathedral we have again full accounts. In its nave was also a labyrinth the position of which can still be seen in the disturbed paving, and a written account of the figures and inscriptions which it contained has been preserved. At the middle was a figure probably of the Archbishop by whom the work was begun. At the four corners were four figures of master masons,

Jehan le Loup, master of the works for sixteen years, who commenced the portals; Gauchier de Reims, master for eighteen years, who wrought the vaults and arches, and also the portals; Bernard de Soissons, who made five vaults, worked on the great rose ("et ouvra à l'O"), and was master during thirty-five years; and Jehan d'Orbais, master of the works. The church was begun in 1211, and the choir was taken possession of in 1241. M. Demaison, in a recent criticism of the data, has arrived at the result that Jehan d'Orbais began the chevet ("coif") and died about 1231, and Jehan le Loup completed it (from 1231 to 1247) and built the *north* portals. Gauchier followed 1247-1255, and was succeeded by Bernard till 1290, during which time he carried on the nave and raised the west front as far as to include the rose, the technical name for which, as known by other documents, was "l'O." It will be seen that the names follow in the same order as that given in the MS. description, only beginning with the last name in following the angles of a square.

While Reims was in progress it was visited (about 1225, by Villars de Honnecourt, a master probably of Cambrai) who has left an interesting MS. book full of notes and drawings, preserved in Paris. It is supposed that Villars built the church of Vaucelles about 1230, that he was then called to Hungary, and on his return built the choir of St. Quentin Cathedral, consecrated 1257. His vellum sketch-book gives us a remarkable view of the range of his interests. He draws the "counterfeit" of a lion from life, makes many studies for sculpture, notes geometrical and mechanical suggestions such as how to make an angel bow at the Holy Name, and gives us a plan of a double-aisled

apse, which he says was "found" in the course of a discussion with Pierre de Corbie.

From the notes which accompany the drawings it appears

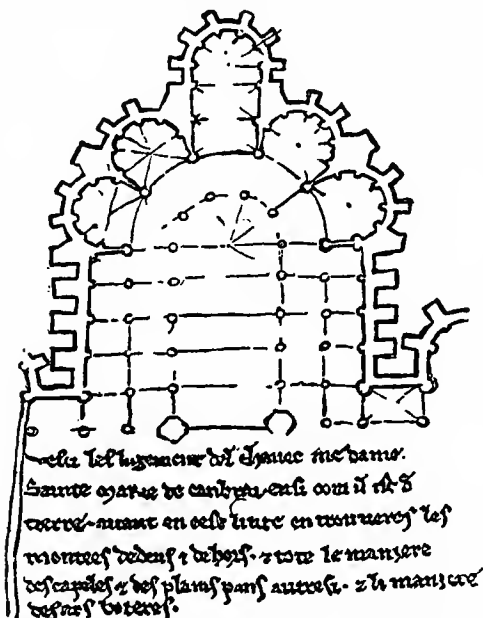

This is a plan of the apse of "Madame Saint Mary"

FIG. 109. Drawing by Villars de Honnecourt of apse of Cambrai Cathedral.

probable that the book was prepared to be handed on either to descendants, or to his Guild, or for "publication." The style of the notes is very similar to that of the recipes of the monk Theophilus. The directions begin: "If you desire to make"—"I will tell you how"—"When I was in Hungary," &c. The volume opens, "Wilars de Honcort"

salutes you, and implores all who labour at the different kinds of works contained in this book, to pray for his soul and hold him in remembrance." Amongst his drawings from buildings we have the north-west tower of Laon—"I have been in many countries, but in no place have I seen a tower equal to that of Laon"—the plan of the chevet (del chavec) of Cambrai Cathedral, "as it is now rising from the ground," the eastern ends of Meaux Cathedral and of the abbey church of Vaucelles (the last dedicated in 1235 and now destroyed), the rose windows at Lausanne and Chartres, the pavement labyrinth in the latter cathedral, and many details of Reims. (Figs. 89, 105, 109.)

At Paris the present cathedral was rebuilt from 1163 to 1235. It was hardly finished before it was injured by fire, and large additional works had to be undertaken, including the transept gables and the outer wall of the chevet. An important inscription on the lower part of the south transept shows that this was the work of Master Jean de Chelles, mason, A.D. 1257. There is much fine sculpture about the door here, which we must suppose was the work of this mason. A deed of sale dated 1265, shows that Jean de Chelles was followed by the celebrated Pierre de Montereau, who is described as *lathomos magister fabricæ ecclesiæ B.M. Paris*.

In 1307 a Pierre de Chelles of Paris, probably a son of the former, was the king's mason and master of the works at Notre Dame. In the same year he agreed to make the tomb of Philippe III.

An inscription on the sculptured screen which enclosed the choir of Notre Dame told that it was commenced by

Master Jean Ravy, *masson*, of Notre Dame for twenty-six years, and was completed by his nephew, Jean le Boutciller, 1351. The Sainte Chapelle (begun 1240 and dedicated 1248), the lovely work of St. Louis, so admired by our own Henry III. that a contemporary poem says he would have liked to have carried it off in a cart, is always said to have been built by Pierre de Montereau (or more properly Montreuil); but of this there is no proof, nor is there any proof of his having directed the works at the Refectory of St. Martin des Champs. He was undoubtedly the master mason of the Lady Chapel at St. Germain des Prés, and it has lately been discovered that he was also master of the works at St. Denis, of which, in a document of 1247, he is described as the "cementarius." Large reconstructions at St. Denis were undertaken in 1231. Pierre, this "doctor of masons" ("Doctor Lathomorum"),* as he was called on his tombstone, which Félibien saw at St. Germain des Prés, was born about 1212, at Montreuil, near Vincennes, and died in 1266. The grave of another of St. Louis' master masons, Eudes de Montreuil, was at the church of the Cordeliers. Thevet gives his portrait from his incised gravestone, and says that he was St. Louis' favourite master, who went with the king to the East and built the towers of Jaffa. He died in 1289. "Many," says Thevet, writing in 1584 (his sympathies evidently went with the old *régime*), "will wonder at the inclusion of his portrait, for he concerned himself with things mechanical, and was not of those who puff themselves up. Michael Angelo,

* Woltmann says the title of Doctor is a frequent equivalent for Master in Italy; he cites a mosaic at Spoleto signed by "Doctor Solsturnus."



FIG. 110. Eudes de Montreuil, Master mason of Paris (lived c. 1220-1289).



PARIS. THE VIRGIN FROM THE NORTH TRAN-
SEPT DOOR OF NOTRE DAME. PROBABLY
BY PIERRE DE CHELLES

industrious as he was, would not have done as much work in sixty years as Eudes in twenty." (Fig. III is drawn from Thevet's plate.)

Bauchal suggests that Eudes may have been related to the last named Pierre; they were both king's masons. Eudes received four sols a day, with 100 sols annually for his robes, also his food and keep for two horses at the palace. Another king's mason to St. Louis in Paris was Guillaume de St.-Patu. One of the most famous Paris masons of the fourteenth century was Raymond du Temple, Maçon du Roi, or Maître des Œuvres de Maçonnerie du Roi. He also was master of the works of Notre Dame. At this time the royal works in Paris were under the charge of a mason and a carpenter. Two others were responsible for the works in Champagne, two others in Languedoc, and two others in Normandy. A fine engraved monument in St. Ouen, Rouen, shows a master mason with his apprentice, and bears the inscription: "Cy gist Maistre Alexandre de Bernval, Maistre des Œuvres de Maçonnerie du Roy, nostre sire: du Baillage de Rouen et de ceste eglise, qui trespassa l'an de grace mil, ccccxl, le v. jour de Janvier." One of the last of the great Gothic masters was Martin Cambiche of Paris. He built the great transepts of Beauvais, receiving forty sols a week, from 1500 to 1537. After this, Jean Vast constructed over the crossing, an immense lantern-tower, four hundred and seventy-five feet high, the vaulting beneath being pierced so that the whole fearful height was visible from the floor of the church.

Rouen Cathedral was begun to be rebuilt after a fire in 1200. The first master seems to have been Jean d'Andeli,

cementarius and *magister* of the fabric of the church. Jean was followed by Ingelram, master of the works, in



FIG. III. The Master mason of an apse of St. Ouen at Rouen (begun about 1308

1214. After him Durand, *le machon*, vaulted the nave in 1233; and on the boss of the last bay of the vault is inscribed, "*Durandus me fecit.*"* In 1251 Gautier de St.

* Is this the same Durandus as the French Master of that name who built Beaulieu Abbey in Hampshire early in the thirteenth century?

Hilaire was master, and the north transept portal was begun in 1278 by his successor, Jean Dair, who was followed by Jean Davy; one of the last two was probably the mason of the great south portal, and the Lady Chapel (1302-1320) is attributed to Jean Davy. One of the stained-glass windows of the ambulatory was signed by Clement of Chartres. In one of the north choir-chapels of St. Ouen, Rouen, is the tomb of a master who most probably began that work, soon after 1300. (Fig. 111.)

On the grave-slab of Libergiers before mentioned (*see* Fig. 108) we have a portrait of the master in his cap and robe of office. The former is to be especially remarked, as where it occurs, as it often does, in mediæval art, it marks men of the degree of doctors or masters. The degree of mastership in the Masons' Guild was closely parallel to that of the master of arts in the university, that is, the Guild of Letters.

By serving a seven-years apprenticeship he became a bachelor or companion, and, on presenting a proper work-thesis, he was admitted master. Our curious courtesy title, "Mr.," does not mean employer, but graduate of guild; however, the two meanings came together, as only a master might be an employer.

In a careful study by Gustave Faquiez (1877) of the methods pursued in building, he concludes that masonry was the most important of the building arts, and that the master always belonged to that craft. A master carpenter, however, gave the plans for the woodwork involved, in consultation with the master of the works.

The king, great personages, and religious establishments

had their own master masons and master carpenters ; such directors of the royal buildings were attached to the

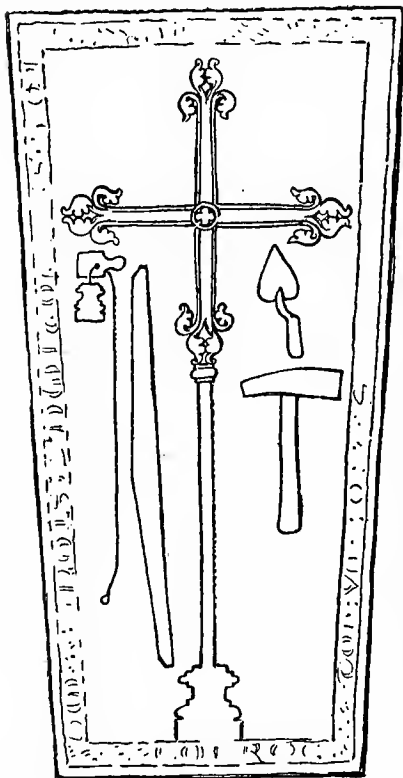

FIG. 112. Gravestone of a master mason, in the Cluny Museum, Paris.

Court, and sworn. These king's masons were, of course, held in high consideration, and were constantly in close contact with the king. The son of Raymond du Temple, king's mason, was godson of the king and a student at the University of Orléans. Apprenticeship done, several of the crafts imposed the test of the master work (*chef d'œuvre*), the wardens of the guild being the examiners. If successful, the new master gave gloves to the wardens and a repast to the guild, and so became a "past-master." When we admit that the great cathedrals of France were technically designed by men bred as working masons, it is not to be inferred that mastership was less esteemed, but that workmanship was more valued. It is, indeed, the most significant fact in regard to Gothic

drals of France were technically designed by men bred as working masons, it is not to be inferred that mastership was less esteemed, but that workmanship was more valued. It is, indeed, the most significant fact in regard to Gothic

art that it marks the triumph of craftsmanship in an age which understood and honoured it.

The mason's tools, the weapons of his craft, were to him what the sword was to the knight, and he loved to have them sculptured on his tomb and charged on his seal. Fig. 112 is a thirteenth-century grave-slab now in the Cluny Museum (see also Fig. 113). This, one of the most interesting of existing memorials, is at Caudebec on the grave of the mason who, we may suppose from his long service, built a great part of the church with his own hand and died in 1484. On one side of a long inscription is engraved the figure of the master, and on the other side is the plan of his work, with his tools—

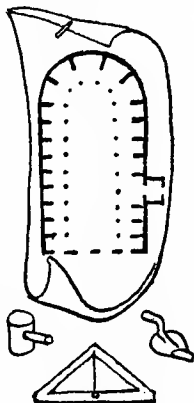

FIG. 113. From grave-stone of master mason at Caudebec.

plummet, mallet and trowel. The inscription begins: "Guillaume Letellier, master mason of the church, who had the conduct of the works for thirty years and more, and erected the choir and chapels." It is worthy of remark that his surname is probably derived from his occupation—the stonecutter. Two facts show that he was the first master; that he built the east end, always the point of beginning, and that the plan was put on his grave.

Fig. 114 shows the seal of one of the early fourteenth-century master masons at Strasbourg, charged with three mason's axes on a bend. Fig. 115 is from a window at Chartres.

The impression that the Cathedrals cannot be assigned

to particular builders, and that mediæval masons were little honoured in their day, is curiously far from the truth. Masonry, including sculpture, was the representative art of the age, and the captains of masonry received most honourable public recognition.

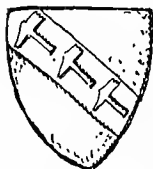

FIG. 114. Seal of master mason of Strasbourg.

Along the lintel of the great central portal of St. James of Compostella is cut a careful inscription about eighteen feet long to the effect that in MCLXXXVIII the doors were completed by Master Matthew who directed the work from the foundation. This inscription is more than a mason's signature. It can only be accounted for by recognising it as a public honour voted to one who had magnificently exercised his craft.

Forming a band at the base of the south transept of Notre Dame, Paris, below the beautiful sculptures which adorn the doorway, is an inscription in large raised letters giving the date of 1257 for the beginning of the new work, and ending with the name of the master mason ("Lathomus")—KALLENSI LATHOMO VIVENTE IOHANNE MAGISTRO (Fig. 117). The formula "Vivente" is often found on tombs, and it is evident that this is an honorary memorial inscribed after the master's death.

At Amiens across the south transept above the door of the "Vierge Dorée" on the cornice is a decayed band of letters seven inches high—EN LAN^Q L INCARNATIO VALOIT MCC & XX . . . 1FV REMIST LE PREMIERE PIERE IASIS . . . LE CORS . . . ROBERT. . . The inscription is in mid-thirteenth century letters, and, according to tradition, refers to Robert of Luzarches the first mason; a tradition which the analogous examples show that we may safely accept.

At Strasbourg, above the great west portal was formerly an inscription which told that in 1277 the glorious work was begun by Master Erwin von Steinbach.

As we have seen, on the practical completion of the Nave of Amiens in 1288, a striking memorial to the first three masters and the contemporaneous Bishop was laid down in the centre of the pavement labyrinth. At Reims



FIG. 115. From stained glass at Chartres.

a similar memorial was dedicated to the first four masters, and a confirmation is given by this fact to the view that these four masters substantially completed the entire work.

At Westminster Abbey there is a remarkable example of such an inscription. On the marble cornice of the Confessor's Shrine, precisely the most honourable position in England, were set letters of blue glass mosaic, three inches high, giving first the date 1279, then the words HOC OPVS EST FACTVM QVOD PETRVS DVXIT IN ACTVM ROMANVS

civis, followed by the name of King Henry III. as having ordered the work. On the mosaic pavement laid down before the altar in 1268 appears the name of the artist Odericus of Rome.

A number of masons' drawings from the Middle Ages

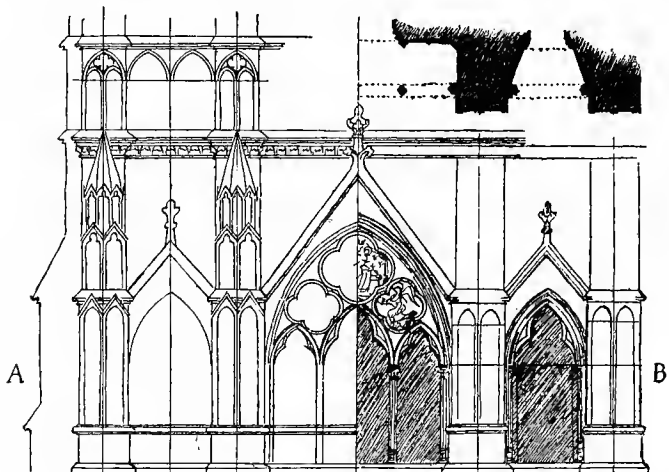

FIG. 116. A, Original design for the west front of a great church of the thirteenth century. B, Suggested interpretation of same.

have been preserved in France, Italy, Germany, and the Low Countries. The earliest of these, after the studies of Villars de Honnecourt (of which an example is given in Fig. 109), are some drawings of a west front of a large church which exist as palimpsests in a book at Reims, and which cannot be later than the middle of the thirteenth century. They are drawn in correct orthographic projection, and two seem to be alternatives for

the same elevation. The one of these, of which Fig. 116, A, is a reduction, is the least interesting, but I wish to offer an explanation of the tracery shown at the central porch. According to Didron (*Annales*, v.) this represents a window drawn in this position because there was no other room on the parchment. On comparing, however, this design as it stands with Libergiers' west front of St. Nicaise it seems clear that the scheme is a reasonable, and indeed almost an inevitable development from it. The right hand side, B, of Fig. 116 and the plan above show how I would interpret it.

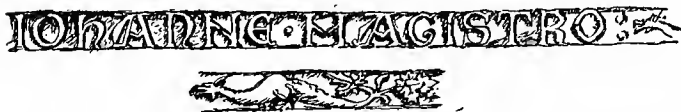

FIG. 117. Inscription in honour of the master mason of Notre Dame, Paris

CHAPTER XI

GOTHIC ART IN ENGLAND, SPAIN, SWITZERLAND, BELGIUM, AND GERMANY

It is impossible in short concluding chapters, dealing with the Gothic style outside France, to do much more than to try to indicate the relationship of its several branches to the parent stem.

The development of Anglo-Norman Romanesque has never been fully traced, and it is possible, as has been said above, that in the two generations following the Conquest steps in development may have been taken here earlier than in Normandy. Before the middle of the twelfth century, however, it is certain that France had taken the lead, and that from that time the English style was in a subordinate position. Many writers contest this on the ground of taste ; they say that they do not like the exaggerated buttress-scaffolding of French High Gothic, and prefer the subtle, shy charm of English examples. But when we inquire in detail, of precedence, of scale, of the science of construction and energy of production ; and of the development of ancillary arts like stained-glass, sculpture in stone and bronze, enamelling, ivory-carving, manuscript-painting, and, indeed, every one of the sectional



ABBAY OF VILLARS (BELGIUM). AN EXAMPLE OF THE
MONASTIC TRANSITIONAL STYLE

arts which make up the drama of architecture, we must confess that the source and strength of Gothic is to be found in North France, and that England followed it, in the transition from Romanesque, step by step at one remove.

Fountains Abbey affords the best opportunity for a study of the English transition, as there a large mass of building work was being continuously carried on for a great number of years, and from contemporary accounts the dates of several parts of the work can be accurately inferred. In 1132 some monks of St. Mary's Abbey, York, deciding to adopt the Cistercian rule, settled at Fountains, and sent messengers to St. Bernard of Clairvaux, who sent back with them Geoffrey, a monk of that place, to teach them. The present buildings were probably not begun for a few years, but there cannot be a doubt that the plan was laid out under the direction of Geoffrey. The greater part of the church seems to have been built under his supervision, as there are certain un-English features about the nave and transepts which are best explained by reference to Burgundian examples. In 1147 there was a great fire, and examination of existing buildings makes it clear that the church belongs to the time before the fire, say 1135-45, and that the chapter-house belongs to the part rebuilt soon after the fire, *c.* 1160. The refectory was most probably built between 1170-79 with the south part of the western range of buildings. A great eastward extension of the church was undertaken at latest about 1210.

The nave has a decidedly Norman character, but this in the main is given to it by the plain scalloped capitals.

The great arches are pointed, and the aisles are covered by pointed barrel-vaults set like a saddle transversely over each bay. In general refinement the work is in advance of anything that up to that time had been seen in England. A few of the capitals have simple carved leafage; if this treatment had been carried throughout the "Norman" effect would be almost entirely absent, and the work would be at once classed as transitional. The transepts, which are equally early, appear even more advanced, for the pointed arches here spring from an impost-moulding instead of from the Norman form of capital, and each bay is lighted by a pair of windows with a circle above them. The central spans of the early church were never vaulted, but were covered by wooden roofs. Over the crossing appears to have been a low lantern-tower. The whole church must have been a very logical and refined building, and we may see in it how the Cistercian puritanism was an element in the preparation of the way for Gothic. The details of the chapter-house are much more elegant and ornamental. The entrance doorways are still circular, but are finely moulded, and the whole work is in a style complete and masterly as far as it goes. No barbaric element survives, and it marks the climax of transitional work. In the refectory (*c.* 1175), the details are still more elegant, and the proportions are tall and slender. The windows are fine, sharply-pointed lancets; those in the gable-ends coupled in pairs, with one shaft between them common to the two. It is a beautiful piece of first Gothic.*

* The monastic orders spread the seeds of Gothic over Europe (see Plate 57).

Fountains is but a chief work of a great Northern school of monastic building, comprising Rievaulx (nave), Kirkstall, Byland, Jervaulx, and many other examples.

Ripon Cathedral, of old a collegiate church, is another fine and early example of this transition Gothic. It is proved to have been commenced before the death of Archbishop Roger of York in 1181. Some details at Ripon, as, for instance, the corbels of the choir-aisles, closely resemble work at Fountains. One of the most interesting parts of the church is the Chapter-house on the south side of the choir, which all writers assign to a date earlier than Roger's work. A recent examination has convinced me that it is in every way all of a piece. Some details of the church, unblighted by restoration, can be seen in the present library. The curious nave should be compared with that of Nun Monkton. Scott's theory of its first form may be accepted, save that there should surely be a lower tier of windows opening in the wall passage. The early work is of high interest and beauty.

We have in Gervase's account of the burning and re-erection of the choir of Canterbury Cathedral clear evidence as to the dates of every part of that structure. Certain touches in the account suggest that Gervase was himself the monastic clerk-of-works associated with the master-mason, William of Sens. "The master" began to prepare for the new work, and to destroy the old, in 1175. In 1176-7 he completed the bays of the high vault from the tower to the east crossing. In the next year he

completed five more pillars on each side, and was preparing to build the vault when he fell from a beam. The master, thus hurt, gave charge of the work to an ingenious monk, who was the "overseer of the masons" (Gervase himself?); but the master from his bed commanded all things, and thus was completed the vault of the eastern crossing. Then the master gave up the work and returned to France, and William, an Englishman, acute in workmanship (masonry, of course), succeeded him. The monks entered the new choir in 1180. In 1181-2 "our mason" erected the pillars of St. Thomas's chapel, and in 1184 completed its vault and roof. In the story of Gervase we have a typical history of mediæval cathedral-building. We start with a pre-existing church made up of Lanfranc's nave and Anselm's choir. The choir is burnt; the clergy camp out in the nave; masons are called in to advise, one being a Frenchman from Sens, who is made resident master, and a monk is appointed as "overseer of the masons"—that is, agent on behalf of the clergy for the accounts. The work is carried on section by section; and the first mason is succeeded by a second before the building is completed. The "design" is careful contrivance to fit the new portion to pre-existing conditions. In this particular case the puzzle of extending the choir through a space contracted by two old side-chapels which were retained was solved with brilliant skill. Gervase himself tells us that the master, not choosing to pull down the side-chapels, gradually and obliquely drew in his work, "all which may be more pleasantly seen by the eyes than taught in writing." This, indeed, is as true now as when Gervase wrote, and a most

beautiful composition of lines results from the economical adaptation. There cannot be a doubt, as is allowed by Willis, that we owe the planning of the entire scheme, including the portion finished by the English mason, to William of Sens.

Canterbury is a French cathedral built on English soil, and the resemblance to Sens itself is strict. The interior of the eastern transept is in general appearance the most advanced part of the work. The large circular windows, undivided, except by iron bars arranged in a pattern, and filled with splendid stained glass, are particularly interesting. Viollet le Duc gives a similar circle, divided only by ironwork, from Dijon. The open arcades in the upper storey of the interior of the ends of the transept were followed, with variations, at Rochester and Salisbury. The large area of stained glass in the church is particularly fine in quality, and is almost identical with work at Sens and other places in France, and must be allowed to have come from that country. Didron assigns it a date between the glass of S. Denis and Chartres, and grants that it is of unsurpassed beauty. The clerestory windows of the choir and apse were filled with a continuous series of single figures representing the ancestors of the Virgin.

In the eastern limb of Lincoln we have another fine example of a Gothic work begun in the twelfth century. St. Hugh began to rebuild the "head" of the church in 1192. Unfortunately the actual head of the church, an apse of singular form, has been destroyed, and only its foundations have been more or less recovered; but at least the lower part of the existing presbytery and its aisles was

probably well advanced by 1200. From a "Life of St. Hugh," written some time before 1235, it appears that the church was complete to the transepts, including the great circular windows, at the time of writing. Viollet

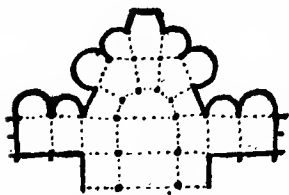

FIG. 118. Lincoln Cathedral, suggested original form of the east end.

le Duc, it is said, did not see much trace of direct French influence at Lincoln; but this surely means that he saw the influence of the Gothic of Normandy. In Fig. 118 is given what I suppose may have been the complete form of the east end of Lincoln. The plan of the apse may be compared with

a memorandum made by Villars de Honnecourt of the apse of the monastic church at Vaucelles, near Cambrai, now destroyed (Fig. 72). The beautiful rose in the north transept of Lincoln looks like a combination of the roses of Chartres and the small interior roses of Notre Dame. Wells Cathedral was also in progress at the end of the twelfth century, and the east end of Chichester is another early work.

From this time there was slight development for the next thirty or forty years. Salisbury, which shows little growth, was begun in 1220, and represents the mid-point between Lincoln, which on the whole, is the finest and completest of our cathedrals, and Westminster Abbey, begun in 1245. It seems probable that this slow development for a period may be accounted for by King John's loss of Normandy in the first years of the thirteenth

century. Westminster Abbey certainly shows renewed contact with French influences. Knowing Westminster, my attention was arrested at Reims last year by several striking resemblances between the French coronation church and our own. Works at the Abbey were begun in July 1245. Four years afterwards we learn that the master mason in charge was one Magister Henricus cementarius. In 1250 the king commanded that six or eight hundred men should work at the church. About 1254 Henry was succeeded by Master John of Gloucester, the king's mason, who carried on the works to 1260, and was in turn succeeded by Master Robert of Beverley, king's mason, under whose charge the work of Henry III. at the church was completed. John of St. Albans, the king's sculptor, is also mentioned in the rolls; he probably wrought the fine figures in the chapter-house and the transepts. In 1269 Edward the Confessor was translated to his new shrine, and the "new work" was consecrated. After the building of Westminster, direct imitation of French work is not evident.*

In my necessary use of terms of comparison, I am far from speaking slightingly of English work. I only speak of less or more as of the magnitude of stars or the mass of mountains. Both schools of the one art are natural and fitting, perfect of their kind. I would, if I could, make use of a comparison of superiority which would not involve inferiority. Moreover, Gothic art in England was a true development *continuously* influenced from France, but not artificially imported.

* I have given some account of the king's masons and the building of the Abbēy church in "Trans. R.I.B.A.," 1901.

In Spain, also, the general law of Gothic expansion was followed, and the French style was more or less made use of in the houses of the new monastic orders. Later, some of the great cathedrals were rebuilt in the matured French manner. Toledo, which has a particularly noble chevet of radiating chapels, the scheme of which Street considered the most perfect anywhere to be found, was begun in 1226, and constructed by a French master. The plan, as Street says, closely resembles that which V. de Honnecourt gives in his book as contrived by himself and Pierre de Corbie, and Enlart suggests that it may be actually derived from this source. In this admirable plan which was to some extent anticipated at Le Mans, there are two ambulatories around the apse with vault compartments alternately square and triangular in each. Ten pillars between the two aisles answer to six in the apse itself, and against the outer wall there are eighteen responds, between which open semicircular chapels opposite the square vault-compartments, and small square ones to the triangular intermediate vaults.

The Cathedral of Burgos is also fine French work, and follows Bourges. The Door of the Apostles has a noble series of sculptures in the tympanum, in the arch orders, and in the jambs. From a photograph it looks as if it must have been sculptured by a master who had worked at Amiens, or on the north doors of Reims. In the tympanum is the Majesty supported by St. Mary and St. John, and angels carrying the instruments of the Passion. In the arch orders are a particularly remarkable series of angels and seraphim, and at the jambs one of the finest series of the Apostles anywhere existing. There are

also many fine sculptures distributed over the west front, including a Gallery of the Kings. At Leon the western porches and sculptures, wrought about 1275, closely resemble those of Chartres.

Savoy and French Switzerland are almost as much provinces of the Gothic style as Normandy. In Geneva and Lausanne are two fine early French cathedrals. The former resembles Lyons, and its towers stand *over* the transepts. It seems to have been begun as a Romanesque work, and to have been modified as it advanced. Around the interior of the choir is a blind arcade on fluted pilasters, the capitals of which are beautifully carved, and two of them have figures from the series of the liberal arts, and are inscribed *MUSICA AND (GEO)METRIA*. The transepts are two bays long, the end bays being under the towers. The crossing is much less from east to west than from north to south, and the transepts are narrow and were evidently intended to bear towers from the first. The first work includes two bays west of the crossing, and there is a preparation in them for sex-partite vaulting, but quadripartite was substituted, and the evidence disappears in the western bays. The west end finishes with a narrow vaulted bay, and always probably had a western gallery as at present. The aisles are narrow and the vaulting rises much more, longitudinally, than do the transverse arches separating the compartments, which look like a series of domed vaults. The windows are broad lancets. A beautiful contrivance is found in the little lights which, around the apse, open to the triforium passage, only one to each double bay of

its arcade, but enough to make it glitter. This noble church has of late years gone through the terrible ordeal of

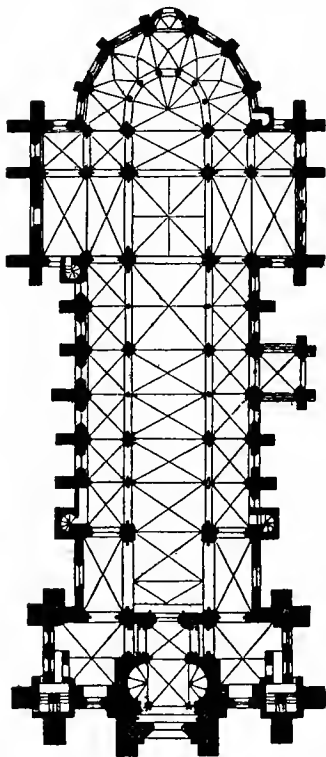
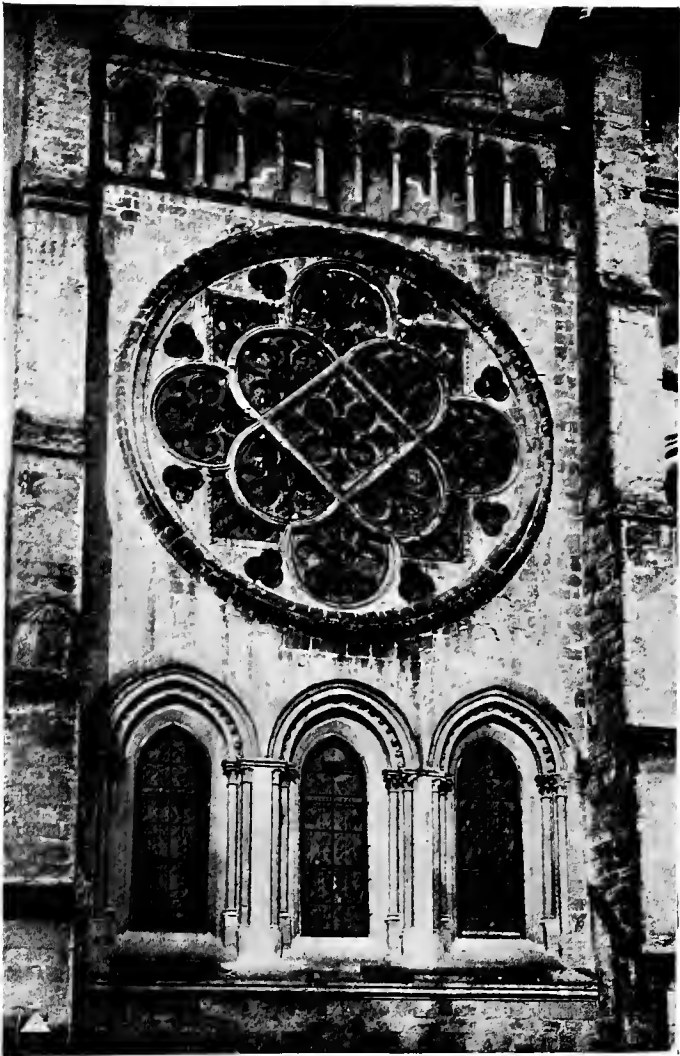

FIG. 119. Lausanne Cathedral, ground plan.

restoration, and restoration, both here and at Lausanne, has been as "thorough" as any in the world. By the expenditure of infinite thought and pains, conscientious and scientific, by means of commissions, reports, and the labours of eminent architects, these buildings have been withered and blasted like our Lichfield, Chester, Worcester, and the exterior of Ripon.

Lausanne has western towers, a central lantern, and a fine rose window in the transept—all probably suggested by Laon. Two other smaller towers, east of the transepts, flank the apse, which finely stands overlooking a deep valley. In the south porch are some good sculptures (Plate 58).

Coire, another early Swiss cathedral, is a mixture of French, German and Lombard elements. It follows the North-Italian type in having a high presbytery over a crypt which is fully visible from



LAUSANNE CATHEDRAL. THE SOUTH TRANSEPT
BEFORE "RESTORATION"

the nave, and its floor is only about two feet below the nave level; the crypt is vaulted on ogives, but the curvature being very flat the centre is sustained by a column which rests on a figure seated on a lion; a composition so identical with pillars at the entrance to the crypt at Modena that they are almost certainly by the hand of the same master (Fig. 59). The nave arcade has simple pointed arches, and the ogival vaults are on pointed transverse arches. All the arches and ribs are in square orders,

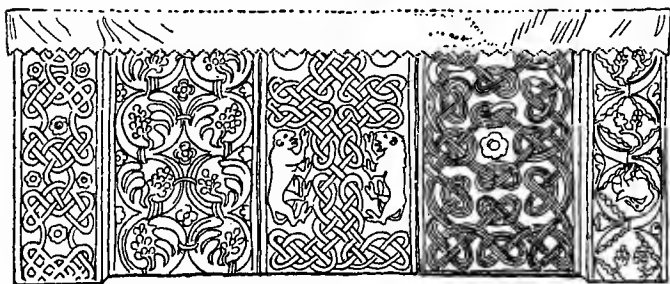

FIG. 120. Coire Cathedral; early altar front of marble.

and the capitals are rudely carved. The plan is almost exactly like that of Zurich Cathedral, comprising a short-aisled nave, a square raised choir, and a small square presbytery to the east. In Zurich, however, the aisle has two compartments to one of the nave; but at Coire the aisle-vaults are much elongated east and west. Zurich, moreover, has a fine vaulted triforium, and all the details are characteristically German. There is a good deal of doubt about the dates of the several parts of Coire, but it seems certain that the superstructure of the nave is an offshoot of early Burgundian Gothic. In the south chapel

there is a very interesting altar-front, being a large white marble altar slab, carved with interlacing patterns identical with those which we in England call Saxon. (See Fig. 120, of which Fig. 121 is an enlarged detail.) Coire is still un-restored, and altogether a most interesting puzzle. Zurich, on the other hand, has been scraped to the very bone.

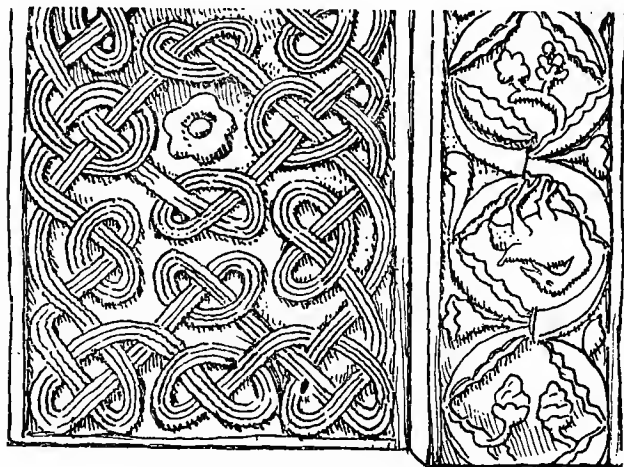

FIG. 121. Coire Cathedral; detail of altar front.

Mediæval art in Belgium developed by continuous interchange with France. In the twelfth century Tournay Cathedral and the bronze-working centre of Huy led: in the thirteenth century France repaid the debt in such buildings as Notre Dame, Bruges, and the Hospital of St. John in the same city. The latter has a finely sculptured door (*c.* 1270) with the Virgin's assumption, and coronation represented in the tympanum. These buildings are



BRUGES. HÔTEL DE VILLE AND BELFRY

Face p. 274

particularly interesting in being built of brick.* In the fourteenth century Flemish artists, as we have seen, again took the lead, and art even in Paris became Franco-Flemish. (Pl. 59.)

In Germany, at monastic centres, there had long been sporadic cases of building in the Gothic style before it had any marked influence on the general native Romanesque, which, indeed, was carried on in places through the fourteenth and fifteenth centuries.† The perfected French style was frankly adopted and imported at Cologne in 1248. The plan is founded on that of Beauvais, and possibly the master had a knowledge of the plans of the church of Amiens. The windows of the earliest part are copies of those at the Sainte Chapelle. Sir G. Scott has preserved an interesting piece of evidence as to the sources of Cologne, showing that "Beauvais rather than Amiens was the type from which it was imitated." "The pinnacles over the eastern chapels at Beauvais are of a very peculiar form, consisting of a pinnacle standing on four detached shafts and placed over another pinnacle, of which the pyramidal part runs up in the midst of the shafts of the upper one, and terminates under its canopy. Now the late M. Zwirner, the architect to Cologne Cathedral, showed me a model of just such a pinnacle that showed the original form of those round the apse there, but he had substituted solid pinnacles for the sake of strength." The nave of Strasbourg is also a pure French work; the towers of Laon are copied at Naumberg and Bamberg, at the latter of which the sculptures of Reims are closely imitated.

* Of later date are many magnificent churches and towers, all of brick.

† Of the monastic transition, Arnsburg is parallel to our Fountains.

CHAPTER XII

GOTHIC ART IN ITALY

THE artistic pre-eminence of France at the end of the twelfth century, and the activity of the Cistercians, resulted in a sort of missionary propaganda of Gothic architecture in Italy. About 1200 was built, close to Rome itself, the church and monastic buildings of Fossanova. The chapter-house, built about 1225, is fairly accurate Burgundian Gothic. Casamari, south of Rome, also a Cistercian house, consecrated in 1217, is a simple but elegant work of lancet Gothic, entirely vaulted. In 1224 the same Order built the Abbey of San Galgano, about twelve miles from Siena. This is a beautiful Burgundian church, vaulted, and in a pure pointed style.

When the two great orders of friars, the Dominicans and Franciscans, needed large churches for their increasing congregations, they were planned very much on the Cistercian type, were covered with ogival vaults, and are generally Gothic, although of a modified form, and, as fitted the circumstances, bare and plain, but logical and stately. Sta. Maria Novella in general arrangement is like a French Cistercian Church a century earlier.

Siena Cathedral was begun in 1245, the same year as



BOLOGNA. MONUMENT OF ROLANDINO, *c* 1300

our own Westminster Abbey. It is remarkable as being a square-ended church; and as the work in 1257 was under the direction of a monk of San Galgano, and as he was followed two years after by a second Cistercian, it can hardly be doubted that the plan itself was of Cistercian origin.

The church has now a central dome which rises above a *hexagonal* area on six pillars, but it is not on the axis of the transepts, and the plan is in many ways irregular. This dome is evidently an afterthought, and must have come about much as did the octagon at Ely. The details of the church are considerably modified from the Cistercian type, and it is built throughout in alternate courses of black and white, a survival from work of the Romanesque period. This treatment is here, however, so strongly marked that it is difficult not to see in it some allusion to the *Balzana* of Siena, blazoned per fess argent and sable. The whole campanile, even to its pyramidal top, and the pinnacles set around it, is carried out in these alternate courses. It is a careful and critical version of the general type of Lombardic tower—a tall shaft, perfectly square, with first a high ground-storey and then a succession of six low storeys, in which, beginning at the bottom, there is a regular gradation of openings, first a single one, then a pair, then three, and so on up to six at the top. It sounds simple, indeed childish, but the result is of rare beauty. The lantern of the central dome has been altered, but a representation of the original form and of the campanile fortunately appears in the pictured allegory of Good Government in the Palazzo Pubblico, painted in the first half of the fourteenth century. On

the apex of the dome was a large leaded globe, and the dome is to be compared with those at Pisa and St. Mark's, Venice. The church was completed in its first form about 1270. In 1340 a vast new nave was undertaken, but it was never carried very far. From *c.* 1360 the choir was rebuilt, about 1375 the west end had two bays added to it, and *c.* 1380 the present west front was completed, following Orvieto.

When the Gothic influence spread beyond the centres where it was planted by the new monastic orders, it became Gothic with a difference. The pointed arch, the ogival vault, and other methods of construction, were accepted and grafted on the native traditional methods. The results were more like varieties of pointed Romanesque of a refined type than like the Gothic of the North. This is particularly the case in the South. (See Plates 60-62.)

One of the first churches which showed a more complete acceptance of the Gothic style was San Francesco at Assisi, the foundation-stone of which was laid in 1228. The friars markedly associated themselves with the spread of the new style. The upper church is boldly vaulted in one span, with tall two-light windows in each bay, and resembles in some degree the nave of Angers Cathedral. The under church is covered by a low vault on stout chamfered ogives. The whole of the interior wall-surface is the field for splendid wall-paintings, some of which were already begun as early as 1240, and were completed by the altogether magnificent series by Giotto of Bible pictures and scenes from the life and teaching of St. Francis, including in four great compositions the allegories of the

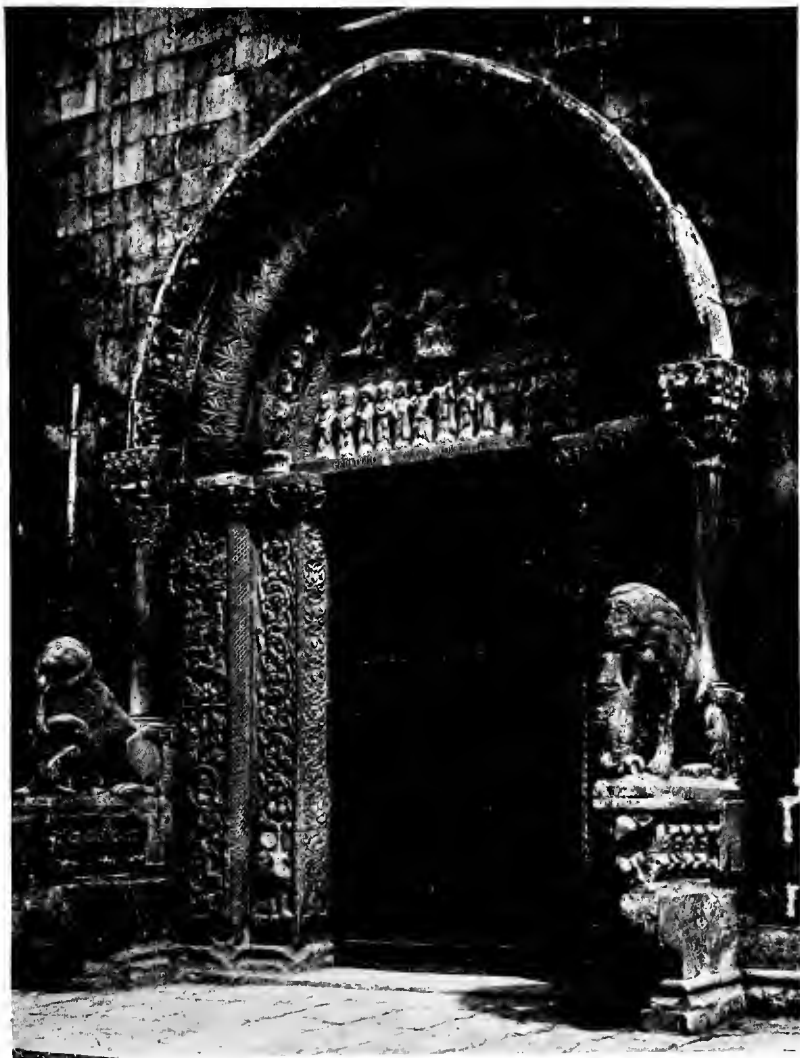

BITETTO CATHEDRAL. SOUTH ITALIAN WORK WITH GOTHIC AND LOMBARDIC INFLUENCE

three vows of the order, Poverty, Chastity, and Obedience, and the glorification of St. Francis himself. The church was consecrated in 1253. In the doorway, and, above all, in the architectural features of Giotto's paintings is to be traced the influence of the "Cosmati" school of marble workers.

By 1260 Niccolò Pisano, the greatest master of his age in sculpture, had been influenced by the new impulse. His pulpit in the Pisa baptistery is signed and dated 1260. It is supported on cusped semicircular arches rising from columns, the alternate ones of which rest on lions in the Lombardic manner. Each side above is formed by a sculptured slab crowded with figures evidently studied from Roman reliefs, yet frank and vivid through and through, and penetrated with Art's new life. The Siena pulpit, undertaken six years later, is almost identical in general design, but the Gothic element is still more in evidence. In the former one the Virtues at the angles are obviously studied from antique originals. Fortitude is a Hercules, and Charity is a Roman matron. The Virtues at Siena have become crowned virgins. A third pulpit, that of Pisa Cathedral, is again very similar. It was the work of Giovanni Pisano, from 1302. The central pillar here is formed by a group of the three theological Virtues, and the four cardinal Virtues support it round about. These Virtues have appropriate emblems. The main pillar stands on a pedestal, on which are sculptured the seven Liberal Arts. The influence of French Gothic art on the sculpture of Italy is as marked as that of the building style. At the Baptistery of Parma there are figures of Solomon and the Queen of Sheba, which can

only have been done by an artist who knew the similar figures at Reims. French stained glass was also adapted.

There are several churches with charming Gothic, or part Gothic, frontispieces in Pisa. San Michele di Borgo is a Gothic translation in small of the cathedral front, having three tiers of cusped arcades standing free from the wall above a plain basement, in which are three round-headed doors. A pretty feature here is a triple tabernacle containing a statue of the Virgin, which rests on the lintel of the central door, and the little gables of which rise above the door arch and veil its form.

Another front of this kind is that of the Church of San Pietro, which is simpler, more logical, and indeed strikingly beautiful. But the most important Gothic monument is the great isolated cloistered court, the Campo Santo, the walls of which, within, are continuously covered with frescoes. The Spina chapel, now so terribly restored, must also be mentioned.

We cannot stay to trace the Gothic school in Verona, Milan, Venice, and, indeed, all over North Italy, but must at once turn towards Florence.

The Dominican Church of Santa Maria Novella, Florence, is said by Villani to have been begun in 1278, but some reasons have been brought forward which suggest that this date applies to the erection of the nave, and that the eastern limb may date from about 1246. If this is the case, it is one of the earliest Gothic works in the city. The fine church of Santa Trinita was rebuilt from *c.* 1250, it is said by Niccolò Pisano, who in that year went to



PALERMO. WINDOW OF S. AGOSTINO. SICILIAN WORK WITH
GOTHIC INFLUENCE

Florence. The other great Friary Church, that of Santa Croce, was begun in 1294. Its fine painted roof is just now being brought to light.

About 1250 was commenced the Bargello, which is a noble example of the castellated palace of the time, reasonable and strong. The style is the development of the local Romanesque with an infiltration of Gothic details.

In 1298 the Palazzo Vecchio was begun. The general form of this building is probably as well known as that of any in the world. It is a great mass of masonry, almost a cube; the upper storey, containing a gallery for defence, is carried by a far-jutting machicoulis, from the projecting face of which rises a tall tower which is crowned within its battlements by an open belfry, the whole about 300 feet high. The supporting of this tower four or five feet in advance of the wall beneath looks fearful in its daring, as is said, "it is built on air." It should be observed that the crowning turret, with its heavy bell, does not stand on the centre of the tower, but is pushed back for some distance, so as to weight the inner wall; and the corbelling is set much closer directly under the tower than elsewhere. The masonry is squared, but the face has a fortresslike roughness. The windows are of white marble and very beautiful, of two lights with cusped heads, and divided by a shaft under a round-headed opening, the arch being slightly pointed on the extrados only. The space over the coupled lights is charged with a fleur-de-lys or a cross alternately.

In our National Gallery there is a careful view of the state of the Palace about 1510, when it was painted by Piero di Cosimo on the background of the portrait of

Soderini, the chief magistrate of Florence. In front is the masonry terrace, the Ringhiera or Rostrum of Florence, since removed, with steps only opposite the door. At the corner of the terrace is the Marzocco, gilded. At the angles of the battlements, directly over the corbels, are other gilt lions in little niches. These have now entirely disappeared. The shields of arms between the corbels were brightly coloured. The copper roof of the belfry was also gilt, and shone over the city like a pyramid of fire. Vasari says that Arnolfo was the architect of this wonderful building, but this is doubtful. It is not in that master's characteristic manner, while it is, on the other hand, in the traditional Florentine style, being a slight advance on the Bargello.

Arnolfo was born at Colle about 1232, and worked for Niccolò at Siena. Between 1280-1290 he was engaged at Orvieto on an important tomb, which is ornamented with mosaic patterns and twisted columns inlaid with mosaic in the style of "Cosmati" work, as well as with fine sculptures. The name of Arnolfo, and the date 1285, appear on the marble mosaic altar-tabernacle in St. Paul's outside the walls, Rome; and most writers agree that this is the same Arnolfo who was given the charge of the proposed new cathedral of Florence in 1296. Arnolfo was a sculptor, and everything goes to show that he had become a follower of the Roman marble-workers, and this explains his scheme for a cathedral of coloured marbles for the Florentines.

At the time of which we are writing this Cosmati work became a great fashion, and artists in this school of workmanship were brought from Rome by our Henry III. to decorate his new abbey church at Westminster. In

1268 the rich mosaic pavement of the presbytery was laid down, and the basement of the Confessor's Shrine was made about the same time, by *Peter, Civis Romanus*. The tomb of Henry III. is also a fine example of this work, and there is a fourth in the small tomb of his little daughter Katharine. Another famous work which was in the Strawberry Hill Collection has entirely disappeared. This was the shrine of Simplicius, Faustinus and Beatrice, erected in Sta. Maria Maggiore, Rome, by Giovanni Capoccio. It was torn from the church and sold to Sir William Hamilton, from whom Walpole obtained it. There is, at the Society of Antiquaries, a large and admirable drawing of it made while it was in its original position. At the sale of the Walpole Collection it was purchased by a Bond Street dealer, and I cannot trace it further. It was a shrine and altar ciborium in

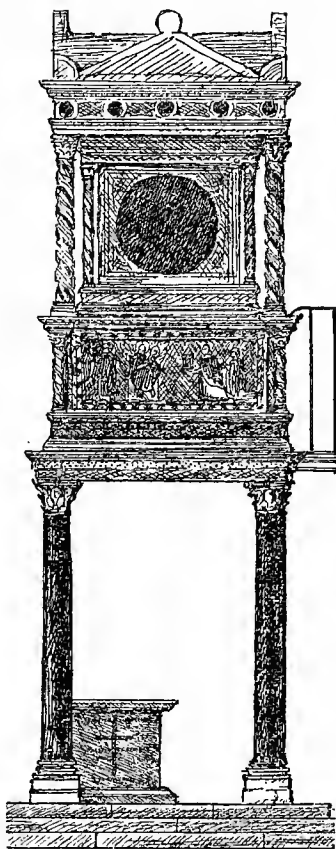

FIG. 122. Altar of "Cosmati" work formerly in S. M. Maggiore, Rome,

one, the shrine being upborne on porphyry columns, and rising to a total height of twenty-five feet.

On the base of the shrine was a mosaic of Capoccio and his wife offering an image of the altar-shrine to the Virgin, and beneath it an inscription, "IACOBVS IOANNIS CAPOCCII ET VINIA VXOR EIVS FERI FECERVNT HOC OPVS PRO REDEMP-TIONE ANIMARVM SVARVM ANNO DOMINI MCCLVI."

The foundation-stone of Santa Maria del Fiore, Florence, one of the largest cathedrals in the world, was laid on September 8, 1296, as is recorded on a stone built into the south wall opposite the campanile, which also names Arnolfo as having been the master. A grant of 1300 provided that Master Arnolfo da Colle del Cambio was to be exempted from a tax because he was *Capo-maestro* of the works, and surpassed every one else in his art, so that Florence was in expectation of having the most beautiful temple in all Tuscany.

Arnolfo died in 1301,* probably leaving a model of the church. It is thought that the church, which appears in Simone Martini's (?) painting in the Spanish chapel represents this model. At least Vasari says it does, "and because he says it, it is not necessary to believe the contrary!" The plan of the church is one of the most perfect of structural schemes, and it is much larger and simpler in its parts than any of the Northern cathedrals. Three limbs, with apsidal terminations, project from the central octagonal space to the east, north, and south; while to the west the nave is formed by only four immense bays.

* The date is variously given up to 1310, but the registration of death in March 1301 has been found. A. Cocchi, "Le Chiese di Firenze," 1903.



FLORENCE. SCULPTURES FROM THE CAMPANILE

The resistance of the three apses against the octagon of the dome is increased by each being surrounded by a continuous row of chapels, and in the re-entering angles other chapels rise against the alternate sides of the octagon as high as the three principal apses.

Did this plan originate from some traveller's account of Santa Sophia, with its central dome sustained by great apses, and those by lesser apses, or is it a bold aggrandisement of Pisa Cathedral, with its dome and transeptal apses? As a matter of fact, it resembles the trefoil form of the Tournay type and the remarkable plan shown in our Fig. 63, and is a member of the group derived from the transversely-apsed Byzantine churches. The great central octagon was doubtless adopted from the Baptistry of Florence.

In 1334 Giotto di Bondone was elected master of the cathedral and of all other public works, and laid the foundations of the campanile in the same year. Giotto was born at Colle, in 1266, one year after Dante. About 1280 he went to Assisi as assistant to Cimabue, and there developed an independent position. In the great series of paintings which cover the Church of St. Francis can be traced Giotto's interest in architecture, and they show, as has been said, that he too had become a follower of Arnolfo and the Cosmati school. The marble Campanile of Florence, one of the most perfect structures in the world, seems at first to be very difficult to account for by the ordinary rules of architectural heredity. This difficulty, perhaps, arises more from the unaccustomed material and details than from the general conception, which to some extent agreed with a line of Florentine

campaniles of which a precious and beautiful example still stands at the church of Ognissanti. A small MS. drawing, made about 1425, of the old church of San Lorenzo shows a campanile still more like that of S. M. del Fiore.* As further evidence of Giotto's direct contact with the Roman marble-workers, whose style is so evident in the decoration of the campanile, we have the fact that Giotto was called to Rome in 1298 to execute the *Navicella* in the portico of St. Peter's. This was a magnificent composition in mosaic, thirty feet by twenty feet, of which a fine early drawing, preserved in the Pembroke Collection, was recently published by Mr. Strong. According to Vasari, Pietro Cavallini, one of the best-known artists of the later Cosmati school, worked under Giotto on this mosaic. Giotto died in 1337, before the construction of the campanile had been far advanced. It is believed it had only been carried up to the first row of reliefs, seven of which, including the Architecture, Painting, and Sculpture, may be assigned to him. (Plates 63-64.) He was followed until 1343 by Andrea Pisano, whose work on the baptistery has been mentioned before. In 1350 Francesco Talenti was the master, and he in 1358 completed the top storey and cornice of the campanile. The cupola of the church was begun in 1420 by Brunelleschi and finished in 1436.

Another curiously romantic work of Florentine Gothic, which must not be passed by without reference, is the Church of Santa Maria di Or San Michele. On its site, from 1290, was a loggia, or open market for the sale of grain. On one of the piers was painted a picture of the

* See A. Cocchi.



FLORENCE. SCULPTURES FROM THE CAMPANILE

Virgin, which became famous as a miracle-worker. In 1337 the foundation-stone was laid of the present building, which was to serve a dual purpose, as a shrine for the precious picture and as a grain store. It is uncertain who designed it, but it is known that Francesco Talenti, Neri di Fioravanti, and Benci di Cione had a part in the work. Soon after 1348 Orcagna began the *Tabernacolo*, a wonder of sculpture, inlaid marble-work, and mosaic; and soon after its completion the open arches of the loggia were, in 1365, filled with elaborate traceried windows. This strange building to the exterior is like a stunted tower, for there is a second storey above the church which gives it considerable height. The interior is finely vaulted, and the small apertures of the complex traceried windows are filled with bright stained glass, giving something of the effect of Cairo lattices. The walls were pictured all over, and the vaults painted blue and starred.

The Ponte Vecchio, one of the noblest monuments of the city, was rebuilt in 1345 on arches of very fine form, the parapets terminated by towers at either end, and with shops on both sides.

One of the last but not the least interesting Gothic buildings in Florence, the construction of which, indeed, overlapped the early days of the Renaissance, is the Loggia dei Lanzi, built from 1376 to 1390, and decorated with charming reliefs of the Virtues, 1383-7.

Orvieto Cathedral, or at least its splendid façade, is a work of the Cosmati school. (Plate 65.) The church was begun to be built in 1290 on a plan more Basilican than Gothic. An interesting point is the way in which lateral

resistance is obtained by a series of chapel-niches opening out of the aisles and effectually buttressing the work. The east end has been altered, but the interior of the nave is nobly fashioned. The capitals, which are especially

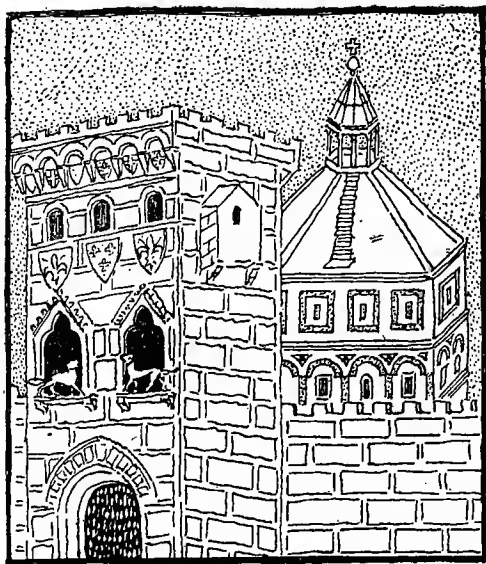

FIG. 123. City gate and the baptistery of Florence from a MS.

beautiful, preserve some reminiscence of Lombard style. The roof is carried on low-pitched king-post trusses, after all, the finest roof of all, save vaulting. The masonry is built in striped courses within and without. The lateral windows are simple lancets. The nave in the main seems to derive from Viterbo, where the columns and capitals are similar.



ORVIETO CATHEDRAL. DOOR JAMB. AN EXAMPLE OF LATE
"COSMATI" WORK

The façade, however, is the special glory of the church. In 1310 Lorenzo Maitano (born *c.* 1275), of Siena, was elected Capo-maestro for the purpose of building this front, and continued to hold the position till his death in 1330. Two original designs for the façade exist which so closely resemble the present one, yet with differences, that there is no doubt that they are by Lorenzo himself. The work is most famous for the reliefs which cover the four main piers which stand between, and right and left of, the three west doors. These reliefs treat severally of the Creation, of the Acts of the Prophets, of Christ's Life, and of the Judgment. The scenes in each are connected by tendrils of foliage much like a Jesse-tree, which, indeed, doubtless furnished the suggestion. One of the reliefs is indicated on one of Maitano's drawings, and it is not to be doubted that he gave the general idea, and possibly he executed those on the two central piers himself. The lateral reliefs are, however, much more elegant, and speak of the coming of the Renaissance. They may be the work of Andrea Pisano, who was chief master here in 1347-8, or of other masters of his school, or of Orcagna. Mr. Douglas Langton, whose examination of the subject I have in the main followed, thinks that they were executed before 1321; but if a comparison is made between the beasts and trees which appear on these reliefs with those on the Florence campanile, it can surely not be doubted that the Florence reliefs are their prototypes. In any case, amongst all the lovely things in Italian Gothic art, these sculptures, in imagination and in execution, are pre-eminent. Nowhere are gentler or more commanding angels, nowhere are

more terrifying devils and more remorseful sinners than here.

Above the four piers which have been spoken of stand four fine bronze symbols of the Evangelists. One of these—the bull—fell about ten years ago, but was carefully repaired. It is seven feet long, and weighs twelve hundred pounds. The harmony of this glorious front has been fearfully injured by restoration, and the doing over of the priceless mosaics by contract-work with due corrections to make them acceptable to modern taste. The original mosaics were begun in 1321. What they were may be seen at South Kensington, where is preserved the Nativity, which filled the tympanum of the right-hand door; one of the most spontaneous and smiling expressions of early Italian art. The colour is exquisite, in parts defined and made glittering with gold, and again melting harmonies of pearl, amethyst, and aventurine green. Notice the fighting cats in the corner, omitted in the trade copy now in place. This panel, moreover, bears the signature of Orcagna, and the date.

ANDR	ANNO
EAS ·	DOMI
CIONIS ·	NI · M
MAGI	CCC
STER	SEXA
M · · V	GESI
M · F	MO

Sieneſe art was eſpecially important in the fields of ſculpture and painting. Let us return to it for a moment to conſider the latter.

Even more perfect of its claſſ than the cathedral is the Palazzo della Signoria, and its ſpecial glory is its

paintings. It was built in 1288-1309, and its slender, springing tower was added from 1338-79. As a town-hall it stands proudly with those of Florence and Bruges; they are the three great municipal buildings of the world.* It is of brick, very simple in its parts, and it is difficult to say in what its power consists. The ground storey is formed by a row of pointed arches, then there are two stages of three-light windows, all alike, and a fourth storey in the middle, crowned by a fine battlement. The mast-like tower rises at one end. The inside is all glorious with paintings, which cover the walls like tapestry. In the great Council Chamber Simone Martini, from 1315, painted the "Queen of Siena." A superbly designed Madonna is enthroned in front of tabernacle-work like an altar-piece, beneath a canopy upheld by attendant saints. To her, kneeling angels offer bowls of flowers, and beneath is an inscription in which she says to the citizens that good judgments delight her more than offerings of flowers, and that he who judges wrongfully will she condemn. On the opposite wall is the portrait, larger than life, of the war-leader of Siena, riding alone in a wide, dark landscape, spotted over with castles.

In the Sala della Pace, Ambrogio Lorenzetti, in 1337-1339 painted the most noteworthy series of civic paintings in any country. Here he represented the Government of Siena and allegories of the effects of good and bad government. In the midst of a series of single figures of the Virtues † sits an aged king or rather crowned Siena, to

* The Town Palaces of Perugia, Todi, Como and others are hardly inferior; the vast hall at Padua is magnificent.

† Peace, Fortitude, Prudence on his right; Mercy, Temperance Justice on his left; above him Faith, Love, and Hope.

292 DUCCIO AND THE BYZANTINES

whom approach the chief citizens of Siena. On his right is enthroned Justice; above, Wisdom holds the scales; below is seated Concord with a big *plane* (!) for emblem. In the allegory of the results of Good Government is a detailed, and doubtless perfectly accurate, view of Siena itself with all the life of its streets, and beyond the walls are the occupations of the country. Hovering over the gate floats the figure of *Securitas*. One of the details is especially interesting to us: a house is being built and we see the scaffolding supported only by horizontal poles jutting out from the walls, and without any uprights.

Simone Martini (c. 1284-1344), and Ambrogio Lorenzetti (c. 1285-1348), followed Duccio, the first of the great individualist painters. Born about 1255, and living to 1319, he himself, in 1302, painted a noble picture for the town palace.* In the work of Duccio, and even of Simone Martini, direct following of Byzantine originals is perfectly evident. A group of the Annunciation, an enthroned Madonna, or an Angel, often appears to be taken directly from some Greek mosaic or book painting: the whole scheme of composition is adopted from the Byzantine traditional treatments, as are also the methods of painting, figures painted on a dark ground, trees laid over dark "mats," and so on. Indeed, panel pictures themselves began as Greek icons, and the custom of painting on gold grounds, which spread over Italy,

* Some slight idea of these Italian Gothic paintings may be formed in the National Gallery before the "Coronation of the Virgin," by Lorenzo Monaco, which is as brilliant in colour as a French miniature, and another "Coronation" assigned to the school of Giotto. There are excellent copies of the "Allegory of Government" on one of the staircases at South Kensington Museum.

France and England, must have been taken over from gold-ground mosaics. Mr. Frothingham has shown that early in the thirteenth century many Greek artists were working in Italy, and that a series of paintings still exist at Subiaco, wrought about 1220, by two Byzantine artists, Conxolus and Stamatiko.

The Italian school of Gothic building—save for some examples, especially those in which a late “Cosmati” strain has become rigid and mean—almost perfectly balanced the romantic and intellectual factors. As compared with the finest Northern Gothic, its works have not the same springing structure and inspiration, but they seem to belong more to this world, and to be less remote from modern eyes. We must remember also that this style was only fully completed by paintings which for beauty and human expression have never been matched. The memory of the old basilicas entirely covered with paintings or mosaics was, in Italy, never lost in any new Gothic ideal, and one of the first conditions of a building was to provide broad spaces for continuous histories in colour. It was not that some selected buildings such as the Palazzo Pubblico of Siena, S. Francesco of Assisi, the Arena Chapel at Padua, and the Spanish Chapel of Santa Maria Novella in Florence, were painted, but *all* walls were incomplete until they had received their proper stories or patterns. The walls of Sta. Maria Novella, Sta. Trinita, Sta. Croce, and Or San Michele, alike give indications of the necessary treatment of church interiors.

One of the most beautiful interiors in Florence is a tiny square vaulted chamber, the *Spezeria* of Santa Maria

Novella, with paintings of the Passion, said to be by Spinello Aretino, c. 1400. At the *Arte della Lana* you pass up a fine stone stair with a lion on the newel and an early Madonna on the walls, to a vaulted hall decorated with a symmetrical series of large single figures on a red ground, in tabernacles, all in fresco. In the Bigallo there is a small chamber completely painted. Here is a central picture of *Misericordia* protecting Florence, which is entirely sheltered by her mantle. The city, surrounded by its walls, shows a good view of the baptistery and other buildings, and on either hand is a crowd of supplicating people. There are a dozen other subjects in square compartments, one of which shows the orphans of the city being received at the Bigallo itself, at the existing door with its Madonna relief. The ceiling, heavily beamed and raftered, is painted with gay pattern-work of chevrons, chequers and bands of quatrefoils in white, black, red and green. The room is perfectly plain and square, but the painted walls and ceiling give out a certain stimulus to the imagination; it is not a mere box but a precious coffer.

The houses, not less than the public buildings, were adorned with their appropriate paintings. Of one traditional method of decorating a room there is a beautiful fourteenth-century example in the Villa Bardini outside Florence, to which it was removed from the Mercato Vecchio. Around the top of the walls are painted the heads of a cusped arcade. Below the level of the springing of these arches is a curtain of diapered stuff represented as if hanging in broad folds in front of the arcade. Showing above the curtain, the arch-spaces are

filled with the foliage of orange and olive trees as if seen through the arches. At the side of a window of the room is the figure of a girl turning back the painted hangings. Over all is a large geometrical lattice pattern, in broad white lines, through the apertures of which is seen the curtain and the tree-tops. This last at once flattens the rest of the painting and gives it mystery, so that the whole becomes a fitting decoration for a room. A somewhat similar treatment, but later, and not so romantic, may be seen on the model of a room from the Palazzo Machiavelli at South Kensington. In other cases the painted hangings seemed as if woven with heraldic devices or diapered over with beasts or plants.

Nor was this colour restricted wholly to interiors. The walls without were touched and accented here and there with gold and painting, as we have seen of the Palazzo Vecchio. Here would be a series of reliefs on coloured grounds like those at the Loggia dei Lanzi, in another place coats-of-arms and badges of the guilds. Some fronts were entirely painted like that of the Bigallo. In several places still remain old coloured shrines. Even the city gates were illuminated, to the outside with painted coats-of-arms, and within, in the tympana of the arches, with pictures. Inside the Porta Romana is an early Virgin enthroned, and at the Porta San Giorgio another, supported by St. George and St. Lawrence. Above the city sparkled the golden mosaic of the front of San Miniato (Fig. 123).

From early days the building style of Florence has had a character of balanced reasonableness which sets it apart even from neighbouring schools. The Romanesque work

of the baptistery and San Miniato is already clear and large-minded, with nothing of Lombardic savagery, as, indeed, Vasari noticed. The Gothic style is equally measured, and the transition to the Renaissance was accomplished here with hardly any disruption of continuity; indeed, the Riccardi and Strozzi Palaces, and even the Pitti Palace, are variations on the traditional style of which the Gothic Ferroni Palace is an example.



FIG. 124. From incised stone slab, in the Cluny Museum, Paris.

We have now followed the main currents of Mediæval Art to the Eve of the Italian Renaissance; to follow the period to its close in the West is beyond the limits of my task. Although the high day of that "Frenchness" which is the essence of Gothic was over-past by the middle



BEAUVAIS. HOUSE FRONT, c. 1550. TIMBER WORK SET
WITH COLOURED POTTERY

of the fourteenth century the change was slow, and lovely works were still being produced when an active propagauda was undertaken for the repudiation of the national arts, and the substitution for them of what was called the "True Antique Style." (See Plate 66.)

I turn away from this short study with a sense of the necessary incompleteness of all history as a mere record of happenings. I am more content, however, to have tried to suggest the unity in diversity of the stream of art which flowed down the centuries, every age showing a different manifestation of one energy as the old tradition was ever new shaped by the need and experiment of the moment. If I may venture to draw out a lesson from the retrospect, it is that we, too, forgetting the past must press forward; for in the future are hid the possibilities of many mighty schools of art as true and strong as the greatest of those that are gone.

APPENDIX

(A) *Byzantine Churches*, p. 48.—The church of St. Irene, Constantinople, is in the main, I have no doubt, a work of Justinian. It was founded by Constantine, and was rebuilt on a larger scale, Procopius says, by Justinian. In the eighth century it was injured by an earthquake, and Revoira assigns the present structure to that date. The originality of the scheme however—a basilica covered by two domes sustained by side-galleries, and the large freedom of the handling—marks it as of the sixth century. The scheme may be described as being made up of the central dome and western arm of the Apostles' Church (Fig. 27), the apse opening directly to the east of the larger of the two domes. In 1881 the apse was cleared out, and marble benches like those of Torcello were found around it. From a photograph it appears that there are monograms of Justinian over some of the capitals.

(B) *The Palace of Mashita*, p. 60.—The most important parts of this monument have been brought to Berlin, and are now amongst the treasures of the new Kaiser Friedrich Museum, Berlin, not yet opened. From a short account of the ruins by Prof. E. Sachou, in *Die Woche*, May 30, 1903, I gather that the most recent German opinion is that it was built for one of the Princes of the Gassanides, a south Arabian tribe of Bedouin, who ruled the trans-Jordan country in the century

before Mahomet. They were in the service of the Emperors of Constantinople, and protected the frontier against the Persians; they were great builders, and employed Greek artists. Their castles are frequently mentioned by the early Arab poets. Mashita is one of these palaces, built in the fifth or sixth century. Some inscriptions have not yet been fully made out. Thus far the view set out on p. 60 is justified.

(C) *Visigothic Art, &c.*, p. 130.—There are only a few remains in Spain which belong to the Visigothic period.

Every student of art knows the splendid votive crowns in the Cluny Museum, one of which bears the name of the Visigothic King Recesvintus. Now the church of St. John de Bonos Cerrato, Palencia, is dated by an inscription of this same king set up in 661. It is a short-aisled basilica, with a square chancel and a large west porch; there are two small square transeptal projections opening opposite the east bay of the nave-arcade, which is of three bays. From the transepts opened two chapels to the east. The chancel arch and that of the porch are of horseshoe form, and the chancel is covered by a barrel vault, in continuation of its arch. The columns are monolithic, and the capitals rude Corinthian. This church, with its projecting transepts, is distinctly cruciform.

Again, the church which Enlart calls the most ancient in N. W. France, that of La Bourse, near Bethune, probably of the tenth century, is also cruciform.

The early Romanesque churches of Romain-Motier and Payerne in Switzerland are both barrel-vaulted.

(D) *Romanesque in France*, p. 132.—The exterior of the choir of the fine late Romanesque church of St. Martin des Champs, Paris, has lately been "discovered" in an entirely authentic state, by the removal of buildings which hemmed it in. It has an apse, with double circumscribing aisle and radiating chapels, all rib-vaulted within. One of the most

interesting features of the exterior is that the roof of the outer aisle of the apse was carried continuously round by means of arches springing across the re-entering angles of the chapels. The revelation of this piece of original work in the crowded streets of Paris made it all the more striking. I suppose its validity is abolished by this time, in the usual way of "restoration."

The extraordinary church of Loches deserves a fuller description than that on p. 182. At the east end are three parallel apses, these and a crossing surmounted by a tower and stone spire are normal, except that the transept roofs "lean-to" against the lantern, which is covered internally by an eight-sided dome. The nave is wider than the crossing, and is of two large square bays of the Angevin type, without aisles. Each of these bays is covered with a low octagonal pyramid rising from squinches. Beyond to the west is another bay vaulted low under a belfry tower, which with its spire rises as high as the central steeple. Still further west is a square porch as large as one of the nave bays and cross-vaulted; in it is a finely sculptured west door beautifully coloured. This strange church is doubtless an adaptation of the domed churches of which there are said to be forty or fifty existing in and around Perigueux. The oldest part is the two-bayed nave, which was probably at first completed with only an apse to the east. It is probably later than St. Hilaire, Poitiers, completed c. 1130. On Le Puy see Thiollier.

(E) *Durham and Ogival Vaults*, p. 132.—Having lately had an opportunity of re-examining the vaults of Durham I feel no doubt of the accuracy of the view set forth by Canon Greenwell and Mr. Bilson. The ogival vaults of the choir aisle (c. 1093) are clearly original. Moreover it is certain that the high vault of the choir was vaulted from the first; traces of it are quite evident on the clerestory walls; the

clerestory windows are not centred with the triforium below, but as required for the "lunettes" of the vaults; substantial buttressing arches remain across the aisles. It is almost as certain that this high vault, completed before 1104, was *ogival*; the tall elliptical form of the lunettes shows this, so also does the subdivision of the apse by attached piers, in comparison with the similar treatment in the chapter-house; indeed, that the central span had ribs may be deduced from the fact that the narrow spans of the adjoining aisles are ribbed, for, as Enlart points out, *ogives* were *augmentations*, and were sometimes put to main spans, while the side spans were left without ("Région Picard, &c."). The high vault of the nave which still remains, and has ribs, agrees in the form of the lunettes over the windows with the choir vault, and it is stayed by buttress arches over the aisles in just the same way, except that those of the nave with a little advance are quadrants instead of semicircles. The main transverse arches of the nave vault are *pointed*. Durham, in its severe rationality, unity, and scale, is an altogether extraordinary work. The whole plan was laid out by some great master, and then it seems to have been carried to a close with hardly an alteration. Amongst early churches with *ogival* vaults may be noted Cormac's Chapel in Ireland, said to have been built in 1127.

(F) *Plans of Churches*, p. 167.—A perfect example of the simple cross plan on which Angers Cathedral was rebuilt is furnished by the ruins of the Abbey of Doué not far away. The plan of La Trinité, Angers, is of a still finer simplicity; the nave is covered by three large sexpartite vaults, plus a half compartment at the west; on either side open seven semicircular niches in the wall-mass, from the nave to the east opens a narrow-apsed choir, with apsed chapels on either hand. Another typical plan of masterly simplicity is that of the Dominican church at Toulouse, which has a double nave,

and a single apse opening from it, the vault of which is therefore supported by a central pier, and resembles half an English chapter-house. The old Dominican churches of Paris and Agen also had double naves, and nothing better could be contrived for the assembling of big congregations before a preacher. Churches with square eastern terminations like the later form of Laon Cathedral are not so infrequent in France as is sometimes supposed. The abbey church of St. Martin in the same city is another example, and it is quite common in churches of lesser rank. A good example is furnished by the beautiful choir of Montrieul-sur-Bois, near Paris (c. 1200). The details of this work have considerable resemblance, in small, to Notre Dame itself. The columns of the arcade are all small monoliths, only 16 inches in diameter, carrying boldly projecting capitals, yet this arcade supports a vault of large sexpartite compartments, the main and intermediate ribs being alike carried by a triple vaulting shaft like Notre Dame (see p. 201), which, indeed, has affinities to quite a group of neighbour churches (see Bull. Mon., 1903, p. 358).

The Friar's Church at Tours (c. 1260) is just one span 160 ft. long, with a big tracery-window to the east.

(G) *Spires*, p. 182.—Dozens of French churches of lesser rank have fine early spires. I may mention Beaulieu by Loches, Limay by Mantes, Notre Dame of Etampes, Langeais on the Loire, Berniers in Normandy, S. Père sous Vézelay, and, above all, the superb steeple of St. Aubin at Angers. I have spoken on p. 163 of transeptal towers; Bordeaux Cathedral was prepared for four such towers, two of which were completed with high stone spires.

(H) *Sculpture*, p. 219.—It may be stated as a general rule that sculpture and ornamental carving developed by translating paintings and book decorations into relief. There is a pattern made up of what I may call a checquer of little semicircles

opposed in pairs, which is found in Carolingian painted books and is a favourite late Romanesque carved ornament. A "Greek Key" pattern treated as a folded ribbon has a similar origin, and foliage forms in carving follow painted models. Some of the very finest Gothic ornamental carving in France carries on the tradition of the classical scroll pattern in exquisite variation. On the lintel of the late Romanesque N. door of Bourges is an acanthus scroll, which would hardly be out of place at Spalato; then through a series we can trace this bold meander of foliage at Sens, Rouen, and Notre Dame. At Amiens there is a band of foliage of another type, but of incomparable boldness and beauty, which runs along under the triforium.

Sculptured doorways of the type of the Royal Doors at Chartres are found at Le Mans, Provins, Etampes, Angers, Bourges, St. Loup de-Naud, Notre Dame at Châlons, Issey, &c. (see Bull. Mon., 1903).

The exquisite life-size statue of Adam in the Cluny Museum shows full mastery over the nude. The statue of Charles V. in the Louvre is clearly a vivid likeness.

Paris held, I believe, the supreme place as a school of sculpture from the middle of the twelfth century.

(1) *Sculpture in England*, p. 235.—Except the King and Queen (Solomon and Saba) at Rochester there is little transitional sculpture in England. There are a few early tomb effigies in very flat relief; but many of these, especially those of a hard black stone, were, I believe, imported from Tournay and other centres. Our earliest effigy in full relief is probably that of King John at Worcester, and this follows the style of Richard's effigies at Fontevrault and Rouen. Step by step French fashions were followed in England, the "weepers" of Fig. 93 are first found in English tombs of c. 1300. The great array of sculptures at Wells distinctly

show close knowledge of French prototypes. By comparison of the pair of central figures of a King and Queen at Wells with similar pairs at Amiens, Chartres, and Reims, I have been able to show that, like these, the Wells figures represent Solomon and Saba.

INDEX

* Indicates figure in text. Names of authors quoted in italics

- AACHEN, Dom of, 2, 4, 90, description of, 121, *seq.*; plan of, *122
 Abbeville, "over-Gothic" of, 188
 Abingdon, double-ended church of, 89 *n.*
 Akhpat, ribbed vaults of, 111
 Akhtamar, church of, 75
 Alexandria, school of ivory carving at, 35, 56
 Amieus, Cathedral of, 142; vault, 157; section of nave, *160; wall, 161; triforium arcades, 171; clerestory, 173; aisle windows, *173; north window, 174; triforium window, 175, *176; screen, 183; description of, 208, *seq.*; sculptures of, 226, *seq.*; masons of, 244, 258
 Anabat, Church of, *77
 Andrea Pisano, 100, 286
 Augers, Cathedral of, proportions of, 168; plan of, *169; description of, 213, 214
 Ani, Church of, 74, 78
 Antioch, Ravenna derived from, 53
Antoniades, 46, 49
 Apse, origin of, 16; transverse, 72, *73, 84, 103, 128, 148, *149, *150, 285; niched, 93, *94, *95; counter, 103, 127
 Apsidal chapels, *165, *166, *167
 Arab-Byzantine School, 4, 66
 Arches, elliptic, *35, 36; pointed, 31, 78, 104, 106, 133, 140, 158, 159
 Architecture, definition of, 12
Arculph, 27, 28, 29, 86
 Arles, sculptures of, 218
 Armenian-Byzantine, 67, 68, 69 characteristics of, 73, 76; construction of, 78
 Arnolfo da Cambio, 282, 284
 Arnsburg, Abbey of, 275
 Arras, tabernacle for relics, 148
 Art, an index of history, 1; a transition from common tradition to individual realism, 8
 Asia Minor, characteristics of school of, 42, 89
 Assisi, Church of San Francesco, 278
 Athelney, cruciform church at, 90
 Athens, monastery of Daphne, 68, *69, 116; church of St. Nicodemus, 68; cathedral of, 78
 Athos (Mount), church of Protaton, 67; church of Vatopedi, 69, *79; triapsidal church plans at, 72; church of Iviron, 79; the Laura, 80
 Auxerre, Cathedral of, window of, *171; description of, 203; west portal, 231
 BAALBEC, 10, 15, 30, 62
 Bamberg, towers of, 275
Bauchal, C., 243, 253
Bayet, M., 126
 Beauvais, Cathedral of, old nave, 124; flying buttresses, 159; apsidal chevet, 165; description of, 210, 211; St. Etienne, 192; St. Lucien, 244
 Belgium, Gothic Art in, 274
 Bernay, 131
Bertaux, 87, 117

- Bethlehem, Church of the Nativity, *57, *seq.*; cross-type, 87; like Pisa, 103
Bilson, 132, 151
 Binbirkilisse, basilica at, 81
 Bitonto, 118
 Borgo San Donnino, Lombardic style at, 113
 Bourges, Cathedral of, plan of, 163; apsidal chevet, 165; window tracery, 172; roof of chapels, 182; *jube*, 183; candlestick, 184; description of, 209, *seq.*; sculptures of, 230, *seq.*
 Braise, church of St. Yved at, tower, 151; plan, *165, 166
 Brickwork—in Constantinople, 36, 68; brick churches, 79; ribs of, 112; Belgian use of, 275
 Bricksworth, basilican church at, 121
 Brindisi, San Benedetto, ogival vaults of, 113
 Brioude, Romanesque church at, 130
Brockhaus, 69
 Bronze-work, Greek origin of, 116; gates of San Paolo outside the walls, 116; at Aachen, 123, *seq.*; Othonian, 125; bronze working school of Huy and Dinant, 126, 216, 274; in German churches, 128; at Orvieto, 290
Brossel, 78
Brown, Prof. Baldwin, 84
 Bruges, Notre Dame, 274; town hall, 291
 Burgos, Cathedral of, 270
Butler, 94
 Buttress, flying, 139, 159 *seq.*; at Bourges, 210; at Le Mans, 213
 Byland Abbey, 160, 265
 Byzantine Art, 5, 6; B. carvings, 16; B. A. in the reign of Justinian, 32; B. building, 36, 38; B. church arrangement, 48 *seq.*; B. organic work, 57; course of B. A. to be traced in Ravenna, 51; B. candlestick, 59; B. palaces, 61 *seq.*; B. A. in Rome, 63; later B. A. 66 *seq.*; dissemination of B. A., 72; B. mosaics (*see* Mosaics); Byzantine, 80, 119, 121, 130
 Byzantine masons and artists, Tirdates, 112, Ailissios, 61, Staurachios, 116, Conxolus, 293, Stamaticeo, 293
 CAEN, St. Nicholas, 131, 182; Holy Trinity, 131, 185; St. Stephen, 131, 151, 213
 Cahors, paintings on cupola, 242
 Cairo, stone friezes, *33; ivory panel, *34, 35; mosque of Amr, 66
 Calabria, Roccella di Squillace, 87, *88
 Cambrai, Cathedral of, 148, 163; plan of apse, *249
 Canterbury, Cathedral of, double-ended type originally, 89*n*, 127; flying buttresses, 159; resemblance to Sens, 199; description of, 265, *seq.*
 Capitals, Old Cairo cap. *34; types of, 38, 39, *40, *41, 42; monograms on, 44, 54, *55, 95; Torcello caps, 92; Orvieto caps, 288
 Carolingian Art, 121, 124
Carter, John, 133, 139
 Carthage, pavement at, 36, *37
 Casamare, Cistercian abbey of, 276
 Castles, Gothic, 138; Syrian, 138, 139; Coucy, 138; royal builders of, 147
Cattaneo, 64, 92
 Candebeac, mason's tomb at, *257
Caviglia, 87
 Chaalis, Cistercian abbey of, 149, *150
 Châlons, Notre Dame at, 164, 184, 203; Cathedral of, *174
 Chars, church at, plan, *162, 163
 Chartres, Cathedral of, flying buttresses, 159; towers, 163; "design" of, 168; apse windows, 170; clerestory windows, 171; rose windows, 173; stained glass, *177, *178, *179, 180; *jube*, 183; vaulting rib, 186; description of, 203, *seq.*; west front, *205; sculptures of, 218, 219, 222; dial-bearing angel, 228; mason's window, *259
 Chevets, 164, 165, 173; at Le Mans, 213
 Chichester, 268
 Chios, 68, *69
 Choirs, 182, *seq.*
Choisy, A., 31, 44, 49, 111
 Christ, early representation of, *3
 Cistercian Order of St. Bernard, 146
 Clermont, basilica at, 120
Clermont-Ganneau, 59
 Cluny, Monastery of, 130, 146
Cocchi, 99*n*
 Coire, Cathedral of, 272, *273, *274
 Cologne, St. Mary in the Capitol, 128; Holy Apostles, 128; Cathedral of, 214, 275
 Comacini masters, 114
 Como, San Fedele, 103; town hall, 291*n*

- Compostella, St. James of, 130; gloria doors at, 218; lintel inscription at, 258
- Conero, 22, 31
- Conques, 130
- Constantinople—artistic capital of the world, 3, 119; Sta. Sophia at, 2, 28, 35, 39, 40, 44, *seq.*, 49, 69, 70, 112; construction in C., 36; St. Mary of the Fountain, 38; Basilica of St. John, 42; Sts. Sergius and Bacchus, *43, 44, 49, 54; Holy Apostles, *47, 48, 94; Chora, 49; Palace of Belisarius, 68; Great Palace, 62; Kalender's Mosque, 66; S. M. Pamma-Karistos, 97; St. Irene, Appendix A; Guilds, 64, 65
- Coptic Art—*see* Egypt
- Corbell, 218
- Cordova, 111
- Corus, 14
- Cosmati work, 72, 104 115, 282, *283, 287
- Coney, 138
- Coutances, cathedral of, 185, 315
- Covel, 79
- Crete, St. Titus, 83
- Cross-churches, 83, *seq.*: cross-font, *87
- Cyprus, church of St. Barnabas, 129
- DAMASCUS, mosque of, 4, 66; colonnaded streets of, 10; Golden Gate of, 15
- Dehio and Von Bezold, 22, 31, 58, 62, 104, 151
- Didot (*Gélis*), and *Saffle*, 242
- Didron, 69, 226, 261
- Dieulafoi, 62
- Dijon, 126; sculptures at, 235; window at, 267
- Doclea, Church at, *83
- Dodona, Church at, *14, 17
- Domes, *Minerva Medica*, Rome, 11; Holy Sepulchre, Jerusalem, 28; Sts. Sergius and Bacchus, Constantinople, 44; Sta. Sophia, 44; Holy Apostles, Const. 48; Galla Placidia, Ravenna, 52
- Domed basilicas, 81, 83; baptistery, Florence, 101; cathedral, Florence, 161, 286
- Domfront, Church at, 131
- Dommartin, Church at, 95
- Duccio, Siennese artist, 292
- Durand, G.*, 243
- Durham, Cathedral of, 2; vaulting, 132, Appendix (E); nine altars, 166
- EARLY Christian Art, development of *3, *10
- Eastern Art, Hellenistic, 15; free and varied, 15; influence upon the West, 81
- Egypt, Byzantine Art in, *33, *34; red and white monasteries, 17 *n.*, 36, 94; Coptic origin of Arab art, 66; St. John of Antinoë, 94, *95; Arment, 94; Barkal, 82
- Enlart*, 58, 151, 270
- English Gothic, 136; transition to 262, *seq.*
- English Romanesque, 132, *seq.*
- English masons and artists; Walter of Durham, 243; William of Canterbury, 266; Master Henry of Westminster, 269; Master John of Gloucester, 269; Master Robert of Beverley, 269; John of St. Albans, 269
- Essen, bronze candlestick, 125
- Etschmiadsin, Church of St. Gregory the Illuminator, 31, 73, *74; cathedral, *75
- FALAISE, castle, 138
- Faquier, G.*, 255
- Félibien*, 243
- Fiesole, Cathedral of, 97; Badia, 103
- Flemish masons, Hézelon of Liège, 130; Gauzon, 130
- Fleury, de*, 49, 56, 58, 83, 88, 104
- Florence, San Miniato, 97, *98, 101, 103, 107, 295; San Lorenzo, 97, 99, 286; Baptistery, 97, 99, 102, *288; Santa Reparata, 97, 99; Santa Maria del Fiore, 101, 161, 284; Giotto's campanile, 101, 285; San Jacopo sopr' Arno, 103, Bishops' chapel, 103; San Stefano, 103; Santi Apostoli, 103; Sta. Maria Novella, 276, 280, 293; Santa Trinita, 280, 293; Sta. Croce, 281, 283; Bargello, 281; Palazzo Vecchio, 281; Ognissanti, 286; Or San Michele, 286, 287, 293; Ponte Vecchio, 287; Loggia dei Lanzi, 287, 295; Spezeria di Sta. Maria Novella, 293, *seq.*; Bigallo, 294; Hall of the Arte della Lana, 294; Villa Bardini, 294; Palazzo Machiavelli, 295; Porta Romana, 295; Porta San Giorgio, 295; characteristics of Florentine style, 102, 295, *seq.*
- Fontevrault, 234

- Fonts, cruciform, 86, *87
 Fossanova, monastery of, 276
 Fouantains Abbey, 166, 263, 265
 Franck-Oberoespach, Dr., 231
 French Romanesque, 129, *seq.*
 Frothingham, Prof., 116, 293
- GAILLARD**, château, 138, 147
Garrucci, 36, 53
 Gaul, 120
Gayet, 81
 Gelati, convent church of, 77
 Geneva, Cathedral of, 271
 German Romanesque, characteristics of, 127, *seq.*
 German Gothic, 275
 German masons—Olo of Metz, 121; Erwin von Steinbach, 259
Gervase, 265
 Giotto, 278, 279, 285, 286
 Gisors, castle of, 138
 Gloucester, bronze candlestick, 125; Cathedral of, 132
 Gothic Art, rise of, 5; exclusively Western, but nourished by the East, 7; origin of name, 135; Frenchness of, 136; inadequate definition of, 137; castle Gothic, 138; date of origin, 140, *seq.*; Gothic architecture, 141, *seq.*; an architecture of towns and guilds, 144; influence of religious orders upon, 146, 276; routes and speed of distribution, 152, 153; "Over-Gothic," 188, *seq.*; comparison of French and English Gothic, 191; progress of in North France, 192; French Gothic, 135, *seq.*; English Gothic, 262, *seq.*; Spanish Gothic, 270; Swiss Gothic, 271, *seq.*; Flemish Gothic, 274; German Gothic, 275; Italian Gothic, 276, *seq.*
 Gothic artists and master masons; Jean Papiu, 234; Jean d'Arras, 234; André Beauneveu, 234, 241; Robert de Launay, 235; Jean le Bouteiller, 235, 251; Jean de Cambray, 235; Etienne d'Auxerre, 238; Claux Sluter, 235; Hennequin de Liège, 235; Philippus Rizuti, 238; Evrard d'Orleans, 238; Villars de Honne-court, 238, 248, 249; Jean Coste, 238; Gerard d'Orléans, 239, 242; Jean de Bruges, 239; Jean d'Orléans, 241; Jan van Eyck, 241; Jean Fouquet, 241; Wormbold and Odon, 243; Robert de Luzarches, 245; Thomas de Cormont, 245; Regnault, 245; Hugh Libergiers, *246, 247, 255; Robert de Coucy, 247; Jehan le Loup, 248; Gauchier de Reims, 248; Bernard de Soissons, 248; Jehan d'Orbais, 248; Pierre de Corbie, 249; Jean de Chelles, 250; Pierre de Chelles, 250; Jean Ravy, 251; Pierre de Montreuil, 251; Endes de Montreuil, 251, *252; Guillaume de St. Patu, 253; Raymond du Temple, 253, 256; Alexandre de Bernval, 253; Martin Cambiche, 253; Jean Vast, 253; Jean d'Andeli, 253; Ingelram, 254; Durand, 254; Gautier de St. Hilaire, 255; Jean Dair, 255; Clement de Chartres, 255; Herbrecht of Cologne, 243; Guillaume Letellier, 257; Master Matthew (Spain), 258; Petrus of Rome, 260, 283; Odericus of Rome, 260; William of Sens, 265
 Grenoble, 120
Gsell, 90
 Guilds, in Constantinople, 64, *seq.*; Comacini Guild, 114; Lombard Guilds, 127; Mediaeval Guilds, 144, *seq.*; Guild widows, 181; Gothic Masons' Guilds, 255
- HELLENESQUE STYLE**, 4, 32, 34; Egypto-Hellenesque, 35; Byzantine-Hellenesque, 67
 Hellenistic Art, 15
Herimann of Tournay, 216
 Hexham, round-tower church of, 90
 Hildesheim, bronzes, 125; painted ceiling, 128
 Honnecourt, Villars de, 158, 159, 164, 166, 170, 173, 189, 195,* 238, 248, 249, 260, 268
 Howell, James, 95
- IBLIN**, Castle of, 139
 Ile de France, architecture of, 113, 138, *seq.*; influences in its development, 148
 Illumination, 242
 Irehud, round towers, 121; Cormac's chapel, 133
 Isauria, capital in church at, *41
 Issoire, example of surface decoration, 130

- Italo-Byzantine, 92
 Italian Romanesque, 91, *seq.*
 Italian Gothic, 276 *seq.*; Italian Gothic Gothic "with a difference," 278; character of, 293; completed by painting, 293
 Italian artists and masons: Master Michele, 97; Fra Jacopo, 100; Andrea Tafi, 100; Apollonio, 100; Andrea Pisano, 100, 286, 289; Piero di Jacopo, 100; Buschetto, 104; Rainaldo, 104; Diotisalvi, 105; Bouanus, 105, 118; Guidetto, 107; Cosmas, &c., 115; Vasalletti, 115; Barisanus, 118; Pietro Lombardo, 127; Giotto, 278, *seq.*; Arnolfo di Cambio, 282, 284; Pietro Cavallini, 286; Francesco Talenti, 286, 287; Brunelleschi, 161, 286; Neri di Fioravanti, 287; Benci di Cione, 287; Orcagna, 285, 289; Loreuzo Maitano, 289; Simone Martini, 291; Ambrogio Lorenzetti, 292; Duccio, 292
 Ivories, Alexandrian, 35; Bishop's Chair, Ravenna, 56; panel, 72; dissemination of, 72, 216; Othonian, 125
- JACOB'S WELL**, Church at, 86
 Jarrow, 121
 Jerusalem, Dome of the Rock, 4, 66; Aksa mosque, 4, 66; Holy Sepulchre, 25, *seq.*, *26, *27, *29; capitals, 40
 Jervaulx, Abbey, 265
 Jouarre, Church at, 120
 Jumièges, 2, 131
- KEF, basilica, *82, 95
 Kerak, Castle of, 139
 Kerouan, Mosque of, *39, 40
 Kondakov, 67
 Koutais, Church of, 78
 Kraus, 22, 31, 58
- LABYRINTH**, in Amiens Cathedral, 245
 Lanciani, 64
 Langton, Douglas, 287
 Laon, Cathedral of: plan, 150; Norman influence, 151; flying buttresses, 159; towers, 163; cloisters 171; glass, *181; west front, 184; sculptures, 221, 228; St. Martin's, 147; towers, 164; sculptures, 222; Bishop's Palace, 198, 222; Templars' Church, 167, *168
- Lasteyrie, 133, 218
 Lausanne, Cathedral of, painted statues, 232; description of, 271, *272
 Leon, Cathedral of, 271
 Le Puy, Church of, 130 1
 Lefèvre-Pontalis, 192
 Liebergiers, Hugh, *246, 247
 Liège, bronze font at, 216
 Liget, St. Jean, 166, 238
 Lincoln, Cathedral of, St. Hugh's Choir, 160; eastern limb, 167, *168; rose window, 168
 Lipsius, 81
 Lisleux, Cathedral of, 213
 Loches, Castle of, 138; Cathedral of, 182; Appendix D.
 Lombardic Art, 91, 92, 108, *113, 114
 Lombardic influence, 98, 105, 107, 126; dispersion of, 127
 London—Holy Trinity, Aldgate, 133; Tower, 147
 Lorenzetti, Ambrogio, 292
 Lorsch, Abbey of, 124
 Lucca, San Michele, *106, 107; inlays, 108
 Lynch, H. F. B., 73, 75, 78
 Lyons, Cathedral of, piers, 156; mouldings, *186
- MADEBA**, mosaic at, 29
 Mainz, Cathedral of, 127
 Mâle, Emile, 219, 221, 223, 226
 Malmesbury, Abbey of, 133
 Le Mans, Cathedral of, apsidal chevet, 165; buttresses, 213; portal, 218
 Mantes, Cathedral of, plan, 162; west front, 184; description of, 201
 Mantz, P., 242
 Marble incrustations, Minerva Medica, Rome, 11; Santa Sabina, Rome, 20; a Roman gift to Christian Art, 22; Byzantine, 49; at Parenzo, 56; at Bethlehem, 58; St. Mark's, Venice, 95; San Miniato, Florence, 98; baptistery, Florence, 101
 Marble masonry, Constantinople, 36; Pisa Cathedral, 104; Siena Cathedral, 277; Florence campanile, 285
 Martini, Simone, 291
 Mashita, Palace of, *61, 62. Appendix (B)
 Masons, their position, 243, *seq.*, 256, *258; tombs of, *118, *243, *245, *254, *267; inscriptions to, 258, *261; drawings of, *260

- Mauriac, Church of, 130
Merimée, Prosper, 142
Merrell, Dr., 62
 Meungs, Church of, 150
Micklethwaite, 83
 Milan, San Lorenzo, 31; Church of the Apostles, 86; St. Satyrus, 90; Sant' Ambrogio, 108, 109, *110
Millet, 69, 116
 Modena, pillar of crypt, *113
Mommert, 21
 Monasteries, St. Catherine, Sinai, 60; White and Red Monasteries, Egypt, 61; St. Gall, 124; Cluny, 130
 Monkwearmouth, Church of, 121
 Monograms, 44, 54, *55, 57, 64, 73, 79, 95
 Monolithic Columns, 182
 Mons, Church at, 166
Monte, Robert de, 199
 Morienvall, Church at, 154
Moore, Prof. 137, 157 n, 201
 Mosaic, Minerva Medica, Rome, 11; St. Peter's, Rome, 18; Sta. Sabina, Rome, 20; Sta. Constantia, Rome, 22, *seq.*; Sta. Pudentia, Rome, 24; Holy Apostles, Constantinople, 48; Salonica, 50, 71; Ravenna, 51, *seq.*; Parenzo, 57; Bethlehem, 59; Sinai, 60; Jerusalem, 66; St. Luke's, Phoebis, 69; Daphne, 69; Sta. Sophia, Const., 70; Sta. Sophia Salonica, 71; "Parcel-mosaic," 72, 104; Vatopedi, 79; Byzantine mosaics in Rome, 64; St. Prassede, Rome, 64; Torcello, 93; St. Mark's, Venice, 95; Baptistery, Florence, 100; Sicily, 117; Aachen, 123; Orvieto, 290
 Mouldings, Byzantine, 96; Gothic, *186, *187
 Murano, 87, 96, 97
- NANTES, roof of church at, 120
 Naumberg, towers of church at, 275
 Neuss, St. Quirinus at, 128
 Niccolo Pisano, 279
 Nicomedia, Church at, 16
 Norman School, 5, 110, 131; influence of, 151; mouldings, *187
 Norrey, Church at, 182, 186
 North Africa, 32, 90
 Norwich, Cathedral of, 133
 Noyon, Cathedral of, early Gothic type, 148; triforium gallery, 151, 171; construction, 163; mouldings, 186, *187; description of, 192, *seq.*
- Nyssa, St. Gregory's Church at, *85, 86
- OGIVAL style; progressive stages of, Transitional ogival, Pointed ogival, Counter-arched ogival, and Complete ogival, 140. (*See* Vaults)
- Opus Alexandrinum, 114, 115, 116
 Orcagna, 287
 Orléansville, basilica at, 16
 Orvieto, Cathedral of, 287, *seq.*
Ostiensi, Leone, 64
 Othonian Art, 124, 125, 128
 Otranto, Church at, 117
 Ourseamp, Abbey of, 159, *172
 Oviedo, Church at, 129
- PADUA, Town Hall of, 291 n; Arena Chapel, 293
 Painting, Byzantine, 49; San Clemente, Rome, 63, 64; San Pietro a Grado, 103; Early Romanesque, 121; German, 128; French, *234, 236, *seq.*, 243; Italian Gothic at Assisi, 278; at Pisa, 280; at Siena, 290, *seq.*; Byzantine influence on, 292
 Palaces, Roman-Byzantine, 61, 62, 68; Florentine, 296
 Palmyra, 10, 15, 62
 Parenzo, capitals at, 39, *seq.*; description of, 56; disposition of, 99
 Paris, Basilica of St. Peter and St. Paul, 120; Nôtre Dame, triforium gallery, 151; plan, 163, *200, Appendix (F); rose window, *175; outer aisle roof, 182; *jubé*, 183; west front, 184; portal front, 185; description of, 199, *seq.*; sculptures of, 225, 226; colour, 232; choir screen, 235; masons of, 250 *seq.*; St. Germain des Prés, flying buttresses, 159; tower, 164; mason of, 251; Sainte Chapelle, construction, 161; window tracery and glass, 174, 180; altar canopy, 183; view of, *202; mason of, 251; St. Martin des Champs, vaulting, *170; St. Jacques aux Pèlerins, statues of, 235
 Parma, Baptistery of, 101; Cathedral of, 103
Paul the Silentary, 44, 46, 49
 Pavements, 56, *37, 72, 102, 114, 116
 Pavia, San Michele, 108
 Perigeux, St. Front, 129
 Perigord, School of, 129
Perrot and Chipiez, 62

- Persia, 67, 78
 Perugia, Town Hall, 291 *n*
 Phocis, Church of St. Luke, 68, 116
 Pisa, disposition of buildings, 99 ;
 Baptistery columns, 101 ; Baptistery,
 105, *107 ; pulpit in Baptistery,
 279 ; Cathedral, 103, *seq.*, 118, 279 ;
 Campanile, 105 ; San Piero a
 Grado, 103 ; San Paolo, 105, *106,
 107 ; San Michele di Borgo, 280 ;
 San Pietro, 280 ; Campo Santo, 280 ;
 characteristics of style, 106 ; Pisan
 lozenge, 106 ; Greek influence on,
 107 ; Pisan arcades, 107, 108
 Pistoia, 107
 Plan, concentric, 10, 90 ; primitive, 16 ;
 basilican, 17 ; early Byzantine, 43, 44 ;
 cruciform, 47 ; triapsidal, 72, 73 ;
 quatrefoil, 73, 74 ; late Byzantine,
 49 ; Strzygowski's classification of
 Byzantine churches, 81 ; French
 Gothic plan, 167, Appendix (F) ;
 Gothic aim in planning, 167, *seq.* ;
 plan of Laon, 198 ; of Angers, 214 ; of
 Orvieto, 237, 288
 Poissy, Church at, 151
 Poitiers baptistery, 120
 Pomposa, capital from, 39
 Portraits, early, 14 ; French Gothic,
 *239, *240, 241, 243
 Prefect, Book of the, 65
 Preger, 46
 Primitive churches, origin of, 16
 Procopius, 44, 47, 58, 86
 Proportion, Gothic, 168, *seq.*
 Pulpitum, 183

Quicherat, 198

 RAMSAY, Abbey church of, 86
 Ravello, bronze doors, 118
 Ravenna, 4 ; San Vitale, 39, *51, 52,
 54 ; Basilica of Hercules, 42 ; St.
 John the Evangelist, 42 ; Tomb of
 Galla Placidia, 52 ; Orthodox
 Baptistery, 52 ; Arian Baptistery,
 52 ; St. Apollinare Nuovo, 52, 53,
 64 ; Mausoleum of Theodoric, 53 ;
 St. Apollinare in Classe, 56 ; Bishop's
 chair, 56, 62
 Reims, Cathedral of, exterior of, 139 ;
 flying buttresses, 159 ; traceried
 windows, 170, *172 ; west front, 185 ;
 nervous energy of, 188 ; description,
 of, 206, *seq.* ; sculptures of, 219, 228,
 229, 230, 232 ; tomb in, *246 ;
 masons of, 247, 248 ; St. Remi, pavement
 of, 182 ; apse, 202 ; St.
 Nicaise, masons of, 247
 Renaissance, 7
Renan, 140
 Rhenish School, 5, 124, *seq.*
Rhodias, C., 47
 Rimini, St. Andrea, 88, *89
 Ripon, Cathedral of, 160, 265
 Rivaux, Abbey of, 160, 265
Rivoira, 64
Robert, R., 131
 Roccella di Squillace, Church of, *98
 Rochester, Castle of, 138 ; Cathedral
 of, west door, 219 ; open arcades, 267
 Rolduc, Abbey of, 126
 Roman Art, transformation of, 3, 9 ;
 Oriental influence upon, 9 ; construc-
 tion, 12 ; syncretic character of, 14 ;
 influence abrogated in Constanti-
 nople, 32
 Romanesque Art, 5, 73, 74 ; Oriental
 sources of, 80, 81, 84, 89, 90 ;
 characteristics of, 80 ; Italian
 Romanesque, 91, *seq.* ; German R.,
 126, *seq.* ; French R., 129, *seq.* ;
 Appendix (D) ; Spanish R., 129, 130,
 Appendix (C) ; English R., 132, *seq.* ;
 Romanesque an architecture fenda
 and monastic, 144
 Romance Art, 135, *seq.*
 Rome, Pantheon, 10, 30 ; Minerva
 Medica, 10, *11, 44 ; Constantinean,
 Art in, 13 ; St. Peter's, 17, *seq.*, 286 ;
 St. Paul's, outside the walls, 20 ; St.
 John Lateran, 20, 115 ; Sta. Sabina,
 20, *21, 124 ; Sta. Constantia, 22,
 *23, 24, 26 ; Sts. Cosmo and Damian,
 *30 ; San Stefano, Rotunda, 31 ; Sta.
 Pudentiana, 24 ; St. Theodore, 26 ;
 Sta. Maria in Cosmedin, 61, 116 ;
 St. Sabas, 63 ; Sta. Maria Antiqua,
 63 ; San Clemente, 63, 114 ; San
 Prassede, 64 ; Lateran Baptistery,
 64 ; Sta. Maria Maggiore, 114, 283 ;
 Sta. Maria Trastevere, 114
 Rouen, Tower of, 147 ; Cathedral of
 description of, 211, *seq.* ; sculptures
 of, 231 ; masons of, 253, *seq.*
Ruskin, John, 92, 231

 ST. DENIS, Abbey church of, 183, 184,
 192, 206, 218
 San Galgano, Abbey of, 276

- St. Gall, Monastery of, 89 n, 124, 127
 St. Germer, Church of, 151
 St. Germigny des Prés, 90, 124
 St. Gilles, church of, 218
 St. Leu d'Esserent, Church of, 162
 St. Omer, Cathedral of, 182
 St. Paul, *Anthym*, 151, 198
 St. Quentin, Church of, *163, 164, 203, 248
 St. Savin, Romanesque abbey church of, 237
 St. Sylvia, 28, 29
 Santiago de Peñalba, Moorish church of, 130
 Salamanca, Chapter-house at, 111
 Salisbury, Cathedral of, nave, 160; open arcade, 267; date, 268
 Salona, mosaic of baptistery, 36
 Salonica, Church of St. George, 50; Sta. Sophia, 53, 71; St. Demetrius, 66, *98, 107; St. Elias, *72
Salzenberg, 31, 44
 Scandalion, castle of, 138
Schlumberger, 72, 112
Schultz and Barnsley, 68, 69; *Schultz*, 112
Scott, Sir Gilbert, 275
 Sculpture, Armenian, 73, 75, 76; Romanesque English crosses, 216; Pisan baptistery, 105; Gothic, 215, *seq.*; aims of Gothic S., 215; schemes of, 223, *seq.*; colour in, 232, *seq.*; pulpits of N. Pisano, 279; Italian Gothic S., 279, 280; Florence campanile, 286; Orvieto Cathedral, 289; French S., Appendix (H); English S., Appendix (I)
 Senlis, St. Frambourg, 161; Cathedral of, 184, 192, 194; sculptures of, 220
 Sens, Cathedral of, 199, 231; Synod Hall, 199
 Sicily, Syracuse, Church of St. Foca, 82; Bagno di Mare, church of Sta. Croce Camerina, 87, *88; Monreale, Abbey of, 88, 117; Cefaliti, Cathedral of, 113, 117; Palermo, palace chapel, 117; Martorana, 117; Stilo, Church of, 117; Sicilian Art under the Normans, 117
 Siena, Cathedral of, 276, *seq.*; pulpit, 279; Palazzo Pubblico, 290
 Sinai, Convent of St. Catharine, 60
 Slon, Church at, 120
 Skripou, Church at, 68, *112
 Soissons, Cathedral of, German influence, 148; towers, 151, *152; construction, 163; description of, 201, 202; St. Jean de Vigne, façade, 185
 Souanetie, Church at, *76, 77
 Spalato, Palace of Diocletian, 10, 16, 61, 62
 Spanish Romanesque, 129
 Spanish Gothic, 270
 Spanish masons, Tioda, 129; "Master Matthew," 258
 Spires, 182, Appendix (G)
 Spoleto, church at, 29
 Strashourg, Cathedral of, *jube*, 183; energy of, 188; nave, 275; sculptures, 231, 232; mason of, 259
 Street, 111, 126, 166, 270
Strzygowski, Dr., 16, 20, 27, 29, 31, 34, 40, 53, 64, 69, 78, 79, 81, 83, 86, 87, 89, 123
 Subiaco, paintings at, 293
Supino, 103, 104
Swainson, Harold, 28
 Swiss Gothic, 271
 Syria, 14, 32, 42; Syrian arch at St. Simeon's, *35; St. Simeon's Church, 61; Ravenna work derived from Syrian, 53; Syrian source of Romanesque, 81; characteristics of School, 89
 TABERNACLE work, 190
 Temple churches, 167, *168
 Terouanne, apse of church at, 95
Texier, 68, 78
Theophilus, 126, 181, 249
Thevet, 243, 251
 Todi, Town Hall at, 291 n
 Toledo, Mosque at, 111; Cathedral of, apsidal chapels, 166; stone roof, 182; plan, 270
 Tombs, Early Christian, *10; Gothic, *218, *220, *224, *227, *233, 234; masons' tombs, *243, *245, 247, 253, 257, *seq.*, *296
 Torcello, Cathedral of, 92, 97
 Toron, Castle of, 138
 Tortoom, Eslick Vank Church, 76
 Toulouse, St. Sermin, 130
 Tournay, Cathedral of, 148; apsidal transepts, 150; construction, 163; towers, 164; shrine of St. Piat, 216
 Tournus, vault, 132
 Tours, St. Martin's, 89, 120

- Towers, Ravenna, 64; Florence Campanile, 101; Pisa Campanile, 105; St. Ambrogio, Milan, Campanile, 109; Mainz Cathedral, 128; origin of lantern towers, 81, 84; disposition of towers, 128, 150, 163, Appendix (G); office of towers, 164
- Tracey-le-Val, Church of, 140
- Tracery-ornament, 190
- Trani, Church at, 118
- Trêves, Palace of, 62
- Treviso, Lombard works at, 127
- Troyes, St. Urbain at, 161
- URGEL, Lombard work at, 127
- VALENCIENNES, Cathedral of, 148, *149
- Van Eyck, Jan, 183, 241
- Vasari, 104, 135, 282, 286, 296
- Vauclles, Abbey of, 166, *167, 248
- Vaults—Byzantine, Skripou, 66, Buirkilisse, 81, Barkal, 81, St. Foca, Priole, 82;—vaulted basilicas, 82; ogival vaults, possible origin of, 111, 113, 133, 134; ogival in the East, 111; ogival vaults non-essential to Gothic, 139; Sant' Ambrogio, Milan, 109; Moorish vaults, 111; Angevin vaults, 113; stalactite vaults, 113; Romanesque cross-vaults, 131; Normau ogival, 132; Durham vaults, 132, Appendix (E); ogival vaults, 140, 154, *155, *157, 158
- Venice: St. Mark's, capitals, 39; plan, 48, 93, *94; mouldings, 96; Venetian Byzantine, 64, 92, 97; Venetian bronze-work, 100
- Venturi, 109, 114
- Vézelay, Cathedral of, shaft-mouldings, 182; choir, 203
- Vienna, bronze candlestick, 125
- Villani, 99, 102, 280
- Villeneuve-le-Vicomte, Church at, *166
- Viollet-le-Duc, 58 n, 164, 175, 191, 198, 201, 207, 226, 267, 268
- Viterbe, Church at, 288
- Vitruvius, 13
- Vöge, 218, 219
- Vogüé, de, 27, 58
- WELLS, Cathedral of, 268
- West fronts, 184, 185; of Chartres, 205, of Orvieto, 289
- Westlake, 206
- Westminster Abbey, a piece of thirteenth-century history, 1; flying buttresses, 159; old foundations, 168; chapter-house windows, 173; Reims prototype of, 208, 269; when begun, 268; tombs in, 236, 283; painting of Richard II., 243; inscriptions to masons, 260; Cosmati work at, 283
- Wetzlar, Cathedral of, 169
- Whittingham, G. D., 139, 201
- Willis, Prof., 171, 267
- Wimpfeu, Church at, 140
- Winchester, Cathedral of, 151
- Widows, Gothic, Tracery, 170, seq., *171, *172, *173, *174, *175, *176; glass, *177, *178, *179, 180, *181, *236, *237; Reims widows, 207; Amiens windows, 209; masons' tools in Chartres window, *259
- Woltmann, 251 n
- ZURICH, Cathedral of, 273